



RF COAXIAL  
CONNECTORS



MICROWAVE  
COMPONENTS

# COAXIAL, RF & MICROWAVE

*Full Line Catalog*



## **SIMPLIFICATION** *is our INNOVATION*

*Radiall is a community of dedicated individuals with a shared purpose: simplify life for all those who innovate. Our manufacturing expertise allows us to deliver lighter and smaller products that simplify implementation and drive performance. We recognize that simplification starts with us, but proves its true benefits when it reaches you.*





# TABLE OF CONTENTS

<b>MCX/MMCX/MMS/MMT/MML Series</b> R113/R110/R209/R210/R302	<b>1</b>
<b>SMPM/SMP/SMP-LOCK™/SMP-COM Series</b> R201/R222/R222L/R2229	<b>2</b>
<b>Board-to-Board: MMBX/SMP-MAX Series</b> R223/R222M	<b>3</b>
<b>Coaxipack 2 Series</b> R694	<b>4</b>
<b>Switching Connectors/Moebius/MC-Card/RP-MCX Series</b> R199/R299	<b>5</b>
<b>SMB/SMB Lock/SMC Series</b> R114/R117/R112	<b>6</b>
<b>SMA/SMA-COM/BMA Series</b> R125/R124/R128	<b>7</b>
<b>Quick-Lock: QMA/WQMA/QN/QRE™ Series</b> R123/R123W/R164	<b>8</b>
<b>BNC/BNC 75 HDTV/BNC-TRX Series</b> R141/R142/R266	<b>9</b>
<b>High Frequency Connectors: N 18 GHz/TNC 18 GHz/ SMA 2.9/2.4 mm series</b> R143/R127/R327	<b>10</b>
<b>N/TNC/C Series</b> R161/R162/R143/R144/R166	<b>11</b>
<b>SSMA/SSMB/SSMC Series</b> R121/R203/R202	<b>12</b>
<b>4.1-9.5/4.3-10/QLI/7/16 Series</b> R170/R183/R184/R185	<b>13</b>
<b>Miscellaneous: BR2/TYPE 43 Series/UHF/IMP/UMP</b> R605/R214/R155/R107	<b>14</b>
<b>High Voltage Connectors (BNC HT-MHV/SHV/THT 20/ HN)/Non-Magnetic Connectors</b> R316/R317/R331/R176	<b>15</b>
<b>Adapters</b> R191/R192	<b>16</b>
<b>Tooling &amp; Accessories</b> R280/R282	<b>17</b>
<b>Coaxial Cable Assemblies</b> C291	<b>18</b>
<b>Microwave Components</b> R404/R41x	<b>19</b>
<b>Banana Plugs</b> R644/R921/R929/R941/R948/R995/R999	<b>20</b>
<b>Part Number Index</b>	<b>21</b>





AEROSPACE



DEFENSE



TELECOM



INDUSTRIAL & RAIL



SPACE



TEST & MEASUREMENT



MEDICAL

# OUR COMPANY

*Since 1952, we have been enabling the future through collaboration with our customers. The results are a range of innovative and award-winning products that customers trust for unrivaled repeatability and performance.*

We are a global company with facilities around the world that specializes in manufacturing the highest-quality interconnect components to support the most demanding applications. At Radiall, you can rely on us to be the industry's global market leader.

## INDUSTRIES WE SERVE

For over 60 years, we have fostered relationships grounded in trust by sharing our extensive market knowledge, technological expertise and experience in each and every interaction. Through an understanding of our customers' unique challenges, we are able to design simple solutions specific to their application and requirements.

Visit [www.radiall.com](http://www.radiall.com) for more information.

## OUR VALUES

Guiding Our Actions  
Every Day



### GROW TOGETHER

*With Our Teams and  
the World Around Us*



### BE GENUINE

*To Foster Mutual  
Trust and Grow*



### MAKE IT SIMPLE

*To Accelerate Innovation*



### DARE TO BE AUDACIOUS

*To Make a Difference*



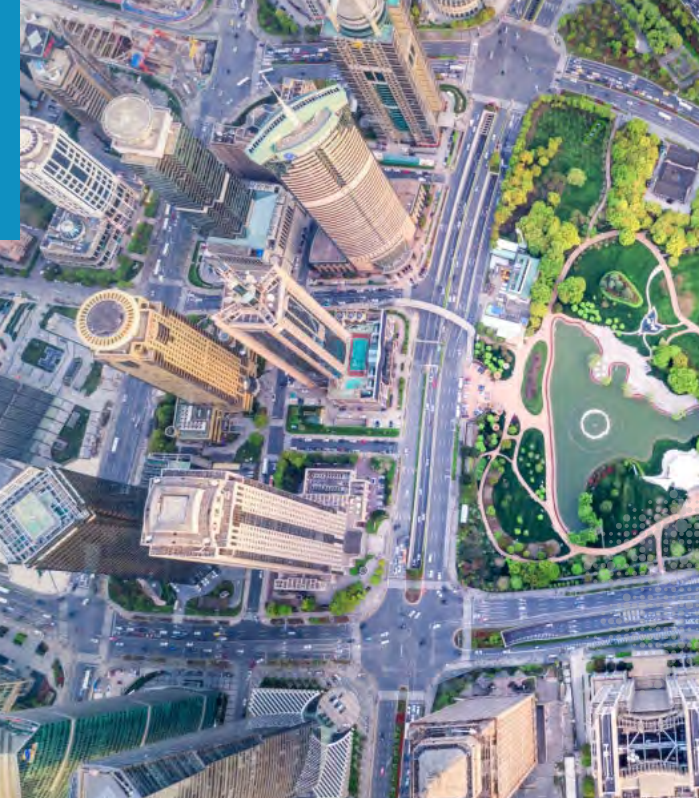

## AWARDS & CERTIFICATIONS

Being recognized for our product performance, innovation and timely fulfillment is a testament to our employees' commitment to our customers. We are a world market leader in reliable, repeatable performance and take great pride in providing award-winning innovation and vendor support.

Our leadership is focused on long-term success and developing key technologies that simplify our customers' lives.

We're committed to our people, the environment and to the highest quality standards including ISO 9001, ISO 14001 and AS9100 certifications. We are compliant with the EU Restriction of Hazardous Substances (RoHS) as well as the Registration, Evaluation, Authorization and Restrictions of Chemicals (REACH) systems.

*Visit our website to view RoHS and REACH compliance information for specific Radiall part numbers.*



Connecticut



Obregón

## IN-HOUSE TECHNOLOGIES

- High-Precision Machining
- Stamping
- Plating
- Molding
- Polishing
- Laser, Ultrasonic, Vapor, Soldering
- Etching on Si
- Thick Film on AlN
- Testing and Simulation



Château-Renault



Shanghai



L'Isle-d'Abeau



Centr'Alp

# GLOBAL PRESENCE

*Recognizing that relationships are rooted in trust, we strive to earn our customers' confidence by demonstrating our market knowledge, technological expertise and experience in each and every interaction.*

- SALES OFFICES
- INDUSTRIAL PLANTS



# COMPREHENSIVE PORTFOLIO

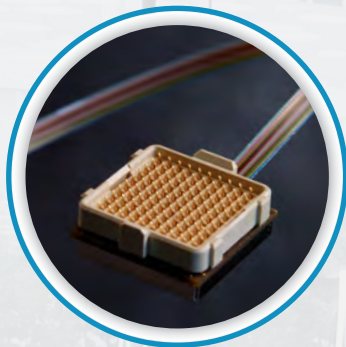

### **Active Optics**

Our high-performance, optical interconnection brand, D-Lightsys®, provides optical transceiver and electronic solutions suitable for harsh environments.



### **Antennas**

With a military and industrial focus, we have solutions for radio tactical communications, vehicles, positioning, LMR/PMR and telemetry applications.



### **Microwave Components**

Our range covers a wide frequency spectrum from DC to 50 GHz, and includes terminations, attenuators, couplers, power dividers, filters and other specialized components.



### **Optical Connectors**

Designed for demanding applications where reliability and high performance are required, our cost-effective optical connectors serve telecom, industrial, aerospace and defense markets.



### **Outdoor Connectors**

Designed for outdoor conditions, our range includes high-power RF coaxial connectors, linking antennas and radio units, as well as innovative multi-signal I/O solutions for optical, Ethernet, power or coaxial links between radio and network.



### **RF & Microwave Switches**

The patented design of our unique, modular actuator and transmission links guarantees operation up to 10 million cycles with superior repeatability.



At Radiall, we provide a comprehensive portfolio of products that meet the application requirements of the key industries we serve. By listening to our customers, we continuously develop new solutions and update our extensive range of products.

With over sixty years of experience and an understanding of the ever-changing business and our customers' technical requirements, we deliver the optimal and most cost-effective, end-to-end interconnect solutions available today.

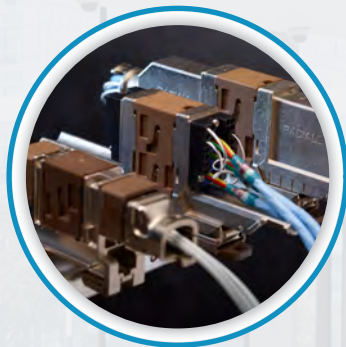

#### ***Multipin Aerospace Connectors***

For more than 40 years, commercial airframes have trusted our range of rack and panel connectors and modular solutions. Our new miniature connector series combines high performance and reduced weight to meet civil and military aerospace industry demands.



#### ***Multipin Industrial Connectors***

Our Van-System brand designs and produces a range of robust circular electrical connectors suitable for harsh environments, such as railways, machine tools, and plant engineering equipment.



#### ***Optical Cable Assemblies***

Our extensive product range and worldwide presence supports customers with standard configurations as well as optimized solutions based on customer requirements.



#### ***RF Cable Assemblies***

Low-loss and high-frequency characterize our extensive range of cable assemblies, including flexible, semi-rigid and hand-formable solutions with a broad combination of cables and connectors.



#### ***RF Coaxial Connectors***

We offer the widest range of RF coaxial connectors in the industry; 55 product series are available, including AEP and Mil QPL connectors.



#### ***Space Qualified Components***

Known for high quality as well as reliability and performance, our product offering includes a wide range of coaxial connectors, cable assemblies, microwave components and switches with a frequency range up to K<sub>a</sub> band.



## SHIPPING INFORMATION

Shipping lead times may vary depending on the location and time zone in which products are stocked or manufactured.

Radiall offers five types of standard packaging, which dictate the first level product container. All of our packages are identified with the Radiall name, part number, lot number and quantity.

# SHIPPING & PACKAGING

*Radiall has various size boxes for optimum packaging and protection.*

- Eco-friendly labeling tape makes it easy to identify Radiall goods. Printing is minimized to reduce processing and all boxes can be recycled (except for the adhesive).
- Each product part number has a dedicated carton box adapted to the size of its packaging.



## TAPE & REEL

Available in 100, 500, 1,800, 3,000 or in custom quantities, products are arranged in an anti-static polyester blister tape covered with a ribbon defender and then rolled up on a polyester reel. This packaging is CEI 286-3 compliant and dedicated to surface mount components. It is compatible with all pick and place automatic machines.



### BLISTER TRAY

Custom, stackable trays minimize damage when shipping fragile or large connectors. These trays protect against shock and even have an anti-dust lid/wrapping.



### BULK

Bulk packaging is available in multiple bags or a box containing 10, 20, 25, 50 or 100 of each component part in separate bags.



### BLISTER BULK PACK

This packaging is suitable for multipart products and small connectors. Radiall offers four types of blister bulk pack depending on the configuration of the product and number of pieces (10, 20, 50 or 100). It is easy to open and ideal for in-field assembly.



### UNIT PACKAGING

All connectors can be ordered in unit bags. The connector and all of the component parts come in individual tear-proof polyethylene bags. Unit packaging must be specified when ordering: add "W" at the end of the part number (except for adapters and specific products).



# NUMBERING SYSTEM

The following guide illustrates the AEP part numbering system for connectors. For additional information or AEP connector data sheets, visit us at [www.radiall.com](http://www.radiall.com). Click on "Product Finder," then "RF Coaxial Connectors" and select AEP.

## AEP PART NUMBERS

Applied Engineering Products (AEP) was established in 1973 and quickly became a recognized leader in the RF coaxial connector and cable assembly industries. In 2005, Radiall, a well known world leader for reliable and innovative product solutions acquired Applied Engineering Products (AEP).

Since acquiring AEP, Radiall has maintained the initial customer-centric service established by AEP over 40 years ago and has become a center of excellence dedicated to providing design engineering, manufacturing, quality and supply chain functions to support worldwide demand.

Today, AEP is a Radiall product brand commercialized alongside the core Radiall RF product lines. AEP connectors and cable assemblies are designed and qualified by our dedicated staff. Radiall is well positioned to serve the needs of the Telecom, Industrial, Defense and Aerospace industries.

## AEP NUMBER SYSTEM

9006-9113-001

A B C D

- A MODEL NUMBER**
- 1000-1999 - SMC
  - 2000-2999 - SMB
  - 3000-3999 - SLB
  - 4000-4999 - N
  - 5000-5999 - Adapters
  - 6000-6499 - TNC
  - 6500-6999 - BNC
  - 7000-7199 - SSMC
  - 7200-7299 - SSMB
  - 7300-7499 - SSLB
  - 8000-8999 - Others
  - 9000-9999 - SMA - SSMA

- B PLATING**
- 1 - Gold
  - 6 - Silver
  - 7 - Nickel
  - 8 - Tin
  - 9 - Passivated

- C MATERIAL**
- 1 - Brass
  - 2 - Beryllium copper
  - 3 - Stainless steel
  - 4 - Brass & Stainless steel
  - 6 - Ph bronze
  - 7 - Brass over Ni

- D CABLE GROUP**
- 01 - RG55, RG142, RG223
  - 02 - RG178, RG196
  - 03 - RG174, RG188, RG316
  - 05 - RD196, RD178
  - 06 - RG58, RG141
  - 07 - RG59, RG62
  - 08 - RD188, RD316, RD174
  - 09 - .141, RG402
  - 10 - .085, RG405
  - 11 - .047
  - 12 - .250, RG401
  - 25 - RD178
  - 30 - RG122

## INGRESS PROTECTION RATING NUMBER SYSTEM

## FIRST DIGIT (PROTECTION AGAINST SOLID OBJECTS)

-  **0** - No protection
-  **1** - Protected against solid objects over 50mm (e.g. accidental touch by hands)
-  **2** - Protected against solid objects over 12mm (e.g. Fingers)
-  **3** - Protected against solid objects over 2.5mm (e.g. tools and wires)
-  **4** - Protected against solid objects over 1mm (E.g. tools, wires and small wires)
-  **5** - Protected against dust - limited ingress (No harmful deposit)
-  **6** - Totally protected against dust

## SECOND DIGIT (PROTECTION AGAINST LIQUIDS)

-  **0** - No protection
-  **1** - Protected against vertically falling drops of water
-  **2** - Protected against direct sprays up to 15° from the vertical
-  **3** - Protected against direct sprays up to 60° from the vertical
-  **4** - Protected against sprays from all directions limited ingress permitted
-  **5** - Protected against low pressure jets if water from all directions - limited ingress permitted
-  **6** - Protected against strong jets of water (e.g. for use on shipdecks) - limited ingress permitted
-  **7** - Protected against the effects of temporary immersion 15cm to 1m. Duration of test: 30 min.
-  **8** - Protected against long periods of immersion under pressure

## INGRESS PROTECTION RATING NUMBER

The rating number refers to a specific test described by an international standard (for example: IEC60529) specifying and classifying the degree of protection from dust and water for particular equipment.

The first digit represents the protection level against solid objects and the second against liquids.

An example on our N clamp type connector: IP67 notes that this connector is totally protected against dust and against temporary immersion between 15cm and 1m.

**Notes**

*Do not mix up IP rating with hermeticity level. Hermeticity sealing is required for microwave modules to provide long term reliability.*

*A measure of hermeticity is the leak rate, which is expressed in atmosphere cc/second, based on the Helium Fine Leak Test (MIL-std 803 or JEDIC-JESD22-A109-A). A traditional hermeticity value must be  $5 \times 10^{-8}$  atm-cc/s Helium or better.*

*Radiall offers a comprehensive range of in-house electroplating for standard or specific uses and conditions. Radiall's plating facility has operated since 1977 in compliance with the latest environmental standards.*

# IN-HOUSE PLATING

## RADIALL PROPRIETARY PLATING

Available coatings are Copper, Nickel, Nickel phosphorous, Tin, Gold, Palladium, white Bronze (BBR), Chromium, Silver, Nickel, Teflon, and passivation of stainless steel. Base materials on which we apply coatings are Copper alloys, Stainless steel, Ferronickel, Zink die cast, Plastic, and Aluminium.

**NPGR (Nickel Phosphorous Gold Radiall)** consists of a thin layer of gold, allowing for good wetability, on top of a layer of electrolytic nickel-phosphorous. With the addition of Phosphorous (>10%), the Ni becomes non magnetic and offers a low intermodulation level. Gold combined with NiP provides excellent protection against corrosion and an ultra low friction coefficient allowing up to 10,000 mating cycles. NPGR is recommended for center and outer contacts, PCB/SMT connector bodies, and for telecom/datacom applications. It is not recommended for solder joints in harsh environment or high temperature applications. NPGR is cheaper than standard gold plating and is compliant with AMS QQN 290 and MiL DTL 45204.

**N2PGR (New Nickel Phosphorous Gold Radiall)** plating is similiar to NPGR but with better corrosion resistance and improved mechanical resistance and reliability of solder joints in high temperatures. This is due to a new Nickel barrier between NiP and gold. N2PGR is compliant with AMS QQN 290 and MiL DTL 45204.

**BBR (Bright Bronze Radiall)** is a copper-tin-zinc base alloy plating, applicable on all copper substrates which looks like bright white silver. It was designed to replace Ni plating and offers better conductivity while being non allergic and non magnetic. Intermodulation generated by BBR is as low as that with silver plating. BBR connectors are solderable using mildly activated flux. Corrosion and tarnishing resistance are among the most important environmental features, plus excellent wearing resistance and mechanical characteristics. BBR is recommended for outer contacts and conductor bodies in cable and panel connectors' applications.

	Solderability	Electrical Performance	Corrosion Resistance	Friction, Mating Durability	IM, Magnetic Properties	Hardness	Tarnishing	Cost
NPGR - N2PGR <sup>1</sup>	+	++	++	++	+	+	+	+
BBR	-	+	++	+	++	++	++	++
Gold / nickel Ni2Au0.2	+	++	++	+	-	+	+	+
Gold / copper Cu2.5Au1.3	+	++	++	+	+	-	+	--
Silver	+	++	+	-	++	--	--	-
Nickel	-	+	++	+	--	+	++	+
NiPTFE	--	+	+++	+++	--	+++	+++	--

### Notes

1. NPGR is not compatible with Zinc die cast (zamak) parts.





*Automatic Plating Production Line*



*Manual Plating Production Line*

### **STANDARD PLATING**

Gold plating has great electrical signal transmission properties. It provides excellent oxidation resistance (even in polluted environment) and mating durability (wear resistant). Gold over copper is mainly used for center and outer contacts. Gold over Nickel is often used for PCB connector bodies to improve solderability. Gold is compliant with MiL DTL 45204.

**Nickel** plating has been widely used on connector bodies and outer conductors for its mechanical and environmental properties. Because of the risk of allergy, Nickel is often used as an underlayer for gold or other noble metals. The Ni layer acts as a diffusion barrier, to prevent the migration of base material atoms (usually copper) to the top coating. Nickel is magnetic thus not suitable for applications requiring a low IM level. Where Nickel plating is used for PCB connectors with solder legs, choose selective tin plating or hot dipping on the legs before soldering. Nickel is compliant with AMS QQN 290.

**Silver's** main advantage is its excellent electrical and thermal conductivity, featuring the lowest contact resistance. Silver plated connectors are particularly suitable for applications where low intermodulation is required. It is also recommended for connector parts that need soldering or brazing. Silver plating is cheaper than gold plating, but tarnishes over time, creating an oxide layer on the surface and affecting its electrical properties. It can be combined with BBR to avoid tarnishing and is compliant with ASTMB700.

**Nickel PTFE** plating can be specified for connectors used in harsh environment for military applications, due to its friction, corrosion and wear resistance. Nickel PTFE is compliant with AMS 2454.

## RF CABLE ASSEMBLIES

CABLE TYPE			CABLE DIMENSIONS MM (INCH)					RADIALL CABLE IF APPLICABLE	
Type	Cable Designation	Cable Group dia. / $\Omega$	Max Freq.	Core Type	Core dia.	Dielectric/ Insulator dia.	Outer dia.	Radiall P/N	Additional Comments
Microcoax & mini coax	N/A	0.8 / 50 S	3 GHz	Solid	0.16 (.006)	0.50 (.020)	0.83 (.033)	C291042066	PFA dielectric
	N/A	1 / 50 S	2 GHz	Solid	0.17 (.007)	0.52 (.020)	1.17 (.046)	C291050060	PTFE dielectric
	50 VMTX Type	1 / 50 S	3 GHz	Solid	0.17 (.007)	0.52 (.020)	1.17 (.046)	C291050066	PTFE dielectric
	N/A	1 / 50 S	6 GHz	7 x 0.08	0.24 (.009)	0.68 (.027)	1.13 (.044)	C291051270	PTFE dielectric
	N/A	1 / 50 S	6 GHz	7 x 0.102	0.30 (.012)	0.89 (.035)	1.37 (.054)	C291066070	PTFE dielectric
	75 VMTX Type	1 / 80 S	2 GHz	Solid	0.10 (.004)	0.57 (.020)	0.80 (.031)	C291055076	PTFE dielectric
	124416 Type	2/50 D	3 GHz	Solid	0.29 (.011)	0.84 (.033)	1.60 (.063)	C291146087	PTFE dielectric
	296775 Type	2/75S	3 GHz	Solid	0.17 (.007)	1.00 (.039)	2.00 (.079)	C291147060	PTFE dielectric
ECO (high performance by Radiall)	ECO 316	2.6 / 50 S	3 GHz	Solid	0.55 (.022)	1.55 (.061)	2.45 (.096)	C291999904	Better than RG316
	ECO 316 X	2.6 / 50 S	3 GHz	Stranded	0.54 (.021)	1.54 (.061)	2.52 (.099)	C291171083	Better T <sup>o</sup> c & power range
	ECO 316 D	2.6 / 50 D	3 GHz	Solid	0.55 (.022)	1.55 (.061)	2.80 (.110)	C291999905	Better than RD316
	ECO 316 DX	2.6 / 50 D	6 GHz	Stranded	0.54 (.021)	1.54 (.061)	3.16 (.124)	C291217020	Better T <sup>o</sup> c & power range
	ECO 142	5 / 50 D	3 GHz	Solid	0.95 (.037)	2.80 (.110)	4.50 (.177)	C291325290	Better than RG142
	ECO 142 X	5 / 50 D	6 GHz	Solid	0.95 (.037)	2.98 (.117)	5.00 (.197)	C291320180	Better T <sup>o</sup> c & power range
	POWER142	5 / 50 D	3 GHz	solid	0.94 (.037)	2.95 (.116)	4.50 (.177)	C291325270	High power level
	ECO 230	6 / 50 D	4 GHz	Solid	1.48 (.057)	4.07 (.160)	5.90 (.232)	C291326490	
	ECO 393	10 / 50 D	3 GHz	Solid	2.40 (.094)	7.25 (.285)	9.10 (.358)	C291491060	Better than RG393
	ECO 393 X	10 / 50 D	6 GHz	7 x 0.8	2.35 (.093)	7.20 (.283)	10 (0.394)	C291512020	ECO393 with high power level
Semi-rigid NF-C-93-551	KS 1	.085"	20 GHz	Solid	0.51 (.020)	1.68 (.066)	2.20 (.087)	C291850001	Copper tubing
	KS 2	.141"	20 GHz	Solid	0.92 (.036)	2.98 (.117)	3.58 (.141)	C291860001	Copper tubing
	KS 3	.250"	20 GHz	Solid	1.63 (.064)	5.31 (.209)	6.35 (.250)	C291870001	Copper tubing
Flexible NF-C-93-550 standard	KX 3B	2.6 / 50 S	1 GHz	7 x 0.16	0.48 (.019)	1.52 (.060)	2.79 (.110)	C291150010	PVC jacket
	KX 4	10 / 50 S	3 GHz	7 x 0.75	2.25 (.089)	7.25 (.285)	10.29 (.405)	C291510010	PVC jacket
	KX 6A	6 / 75 S	1 GHz	7 x 0.20	0.60 (.024)	3.70 (.146)	6.10 (.240)	C291351012	PVC jacket
	KX 8	10 / 75 S	1 GHz	7 x 0.40	1.20 (.047)	7.25 (.285)	10.29 (.405)	C291550012	PVC jacket
	KX 13	11 / 50 D	11 GHz	7 x 0.75	2.25 (.089)	7.24 (.285)	10.80 (.425)	C291600000	PVC jacket
	KX 14	22 / 50 S		Solid	5.0 (.197)	17.30 (.681)	22.10 (.870)	N/A	
	KX 15	5 / 50 S	1 GHz	19 x 0.18	0.90 (.035)	2.95 (.116)	4.95 (.195)	C291305010	PVC jacket
	KX 21A	2 / 50 S	3 GHz	7 x 0.10	0.30 (.012)	0.84 (.033)	1.78 (.070)	C291145017	FEP jacket
	KX 22A	2.6 / 50 S	3 GHz	7 x 0.17	0.53 (.021)	1.52 (.060)	2.49 (.098)	C291170017	FEP jacket
	KX 23	5 / 50 D	3 GHz	7 x 0.34	0.92 (.036)	2.95 (.116)	5.10 (.200)	C291322017	Fiber glass jacket
	KX 24	11 / 50 D	11 GHz	7 x 0.80	2.40 (.094)	7.25 (.285)	10.90 (.429)	C291605017	Fiber glass jacket
	KX 25	6 / 75 S		7 x 0.23	0.71 (.028)	3.70 (.146)	5.90 (.232)	N/A	
	KX 30	6 / 93 S		Solid	0.64 (.025)	3.70 (.146)	6.15 (.242)	N/A	
	KX 52	6 / 75 S		Solid	0.64 (.025)	3.70 (.146)	6.10 (.240)	N/A	
Standard flexible HD	Mini RG59 Type	4.6 / 75 D	4.5 GHz	Solid	0.60 (0.24)	2.80 (.110)	4.60 (.181)	C291033039	
	RG59 Type	6 / 75 D	4.5 GHz	Solid	0.81 (.032)	3.68 (.145)	5.92 (.233)	C291360093	
	RG6 Type	7 / 75 D	4.5 GHz	Solid	1.02 (.04)	4.56 (.18)	6.95 (.274)	C291384083	
LMR <sup>®</sup> *	LMR 200	5 / 50 S		Solid	1.12 (.044)	2.95 (.116)	4.95 (.195)	C291316070	PE jacket
	LMR 400	10.3 / 50 S		Solid	2.77 (.109)	7.24 (.285)	10.3 (.405)	C291516070	PE jacket
	LMR 600	15.2 / 50 S		Solid	4.47 (.176)	11.56 (.455)	14.99 (.590)	C291626070	PE jacket
AEP (equivalent to LMR <sup>®</sup> *)	AEP-100FR	2.6 / 50 S+F	6 GHz	Solid	0.46 (0,018)	1.52 (0,06)	2.79	C291327060	Flame retardant
	AEP-195FR	5 / 50 S+F	6 GHz	Solid	0.94 (0,037)	2.79 (0,11)	4.95	C291327010	Flame retardant
	AEP-200FR	5 / 50 S+F	6 GHz	Solid	1.12 (0,044)	2.95 (0,116)	4.95	C291327020	Flame retardant
	AEP-240FR	6.1 / 50 S+F	6 GHz	Solid	1.42 (0,056)	3.81 (0,15)	6.1	C291327030	Flame retardant
	AEP-400FR	10.3 / 50 S+F	6 GHz	Solid	2.74 (0,108)	7.24 (0,285)	10.29	C291327040	Flame retardant
	AEP-600FR	15 / 50 S+F	6 GHz	Solid	4.47 (0,176)	11.56 (0,455)	14.99	C291327050	Flame retardant
Flexible MIL-C-17 standard	RG 6 A/U	8 / 75 D		Solid	0.72 (.028)	4.70 (.185)	8.43 (.332)	N/A	
	RG 11 A/U	10 / 75 S		7 x 0.4	1.20 (.047)	7.25 (.285)	10.29 (.405)	N/A	
	RG 12 A/U	10 / 75 S		7 x 0.4	1.20 (.047)	7.25 (.285)	12.06 (.474)	N/A	
	RG 58 C/U	5 / 50 S	1 GHz	19 x 0.18	0.90 (.035)	2.95 (.116)	4.95 (.195)	C291305000	PVC jacket
	RG 59 B/U	6 / 75 S	1 GHz	Solid	0.57 (.022)	3.71 (.146)	6.15 (.242)	C291360000	PVC jacket
	RG 62 B/U	6 / 93 S	1 GHz	Solid	0.64 (.025)	3.71 (.146)	6.15 (.242)	C291400000	PVC jacket
	RG 63 B/U	10 / 125 S		Solid	0.65 (.026)	2.95 (.116)	10.29 (.405)	N/A	
	RG 71 B/U	6 / 93 D		Solid	0.64 (.025)	3.71 (.146)	6.22 (.245)	N/A	
	RG 140 /U	6 / 75 S		Solid	0.64 (.025)	3.71 (.146)	5.92 (.233)	N/A	
	RG 141 A/U	5 / 50 S	1 GHz	Solid	0.99 (.039)	2.95 (.116)	4.83 (.190)	C291315007	Glass fiber jacket

## RF CABLE ASSEMBLIES

CABLE TYPE				CABLE DIMENSIONS MM (INCH)				RADIALL CABLE IF APPLICABLE	
Type	Cable Designation	Cable Group dia. / W	Max Freq.	Core Type	Core dia.	Dielectric/ Insulator dia.	Outer dia.	Radiall P/N	Additional Comments
Flexible	RG 142 B/U	5 / 50 D	12.4 GHz	Solid	0.94 (.037)	2.95 (.116)	4.95 (.195)	C291320007	
MIL-C-17	RG 144 /U	10 / 75 S		7 x 0.45	1.35 (.053)	7.25 (.285)	10.40 (.409)	N/A	
standard	RG 165 /U	10 / 50 S		7 x 0.8	2.40 (.094)	7.25 (.285)	10.40 (.409)	N/A	
continued	RG 174 A/U	2.6 / 50 S	1 GHz	7 x 0.16	0.48 (.019)	1.52 (.060)	2.79 (.110)	C291150000	PVC jacket
	RG 178 B/U	2 / 50 S	3 GHz	7 x 0.1	0.30 (.012)	0.84 (.033)	1.78 (.070)	C291145007	FEP jacket
	RG 178 B/U	2 / 50 S	3 GHz	7 x 0.1	0.30 (.012)	0.84 (.033)	1.83 (.072)	C291145060	PVC jacket
	RG178 non m.	2 / 50 S	3 GHz	7 x 0.1	0.29 (.011)	0.84 (.033)	1.80 (.071)	C291140087	Nonmagnetic / FEP jacket
	RG 179 B/U	2.6 / 75 S	3 GHz	7 x 0.1	0.30 (.012)	1.60 (.063)	2.54 (.010)	C291210007	FEP jacket
	RG 187 A/U	2.6 / 75 S	3 GHz	7 x 0.1	0.30 (.012)	1.60 (.063)	2.79 (.110)	C291211006	PTFE jacket
	RG 188 A/U	2.6 / 50 S	3 GHz	7 x 0.17	0.51 (.020)	1.52 (.060)	2.79 (.110)	C291160006	PTFE jacket
	RG 196 A/U	2 / 50 S	3 GHz	7 x 0.1	0.30 (.012)	0.86 (.034)	2.03 (.080)	C291110006	PTFE jacket
	RG 212 /U	8 / 50 D		Solid	1.41 (.056)	4.70 (.185)	8.43 (.331)	N/A	
	RG 213 /U	10 / 50 S	1 GHz	7 x 0.75	2.26 (.089)	7.24 (.285)	10.30 (.406)	C291510000	PVC jacket
	RG 214 /U	11 / 50 D	11 GHz	7 x 0.75	2.25 (.089)	7.24 (.285)	10.80 (.425)	C291600000	PVC jacket
	RG 215	10 / 50 S		7 x 0.75	2.25 (.089)	7.25 (.285)	10.29 (.405)	N/A	
	RG 216 /U	11 / 75 D	3 GHz	7 x 0.4	1.21 (.048)	7.24 (.285)	10.80 (.425)	C291610000	PVC jacket
	RG 217 /U	14 / 50 D	3 GHz	Solid	2.69 (.106)	9.40 (.370)	13.84 (.545)	C291620000	PVC jacket
	RG 218 /U	22 / 50 S	1 GHz	Solid	4.95 (.195)	17.27 (.680)	22.10 (.870)	C291630000	PVC jacket
	RG 223 /U	5 / 50 D	12.4 GHz	Solid	0.89 (.035)	2.95 (.116)	5.38 (.212)	C291330000	PVC jacket
	RG 225 /U	11 / 50 D	1 GHz	7 x 0.8	2.38 (.094)	7.24 (.285)	10.90 (.429)	C291605007	Glass fiber jacket
	RG 303 /U	5 / 50 S		Solid	0.94 (.037)	2.95 (.116)	4.32 (.170)	N/A	
	RG 316 /U	2.6 / 50 S	3 GHz	7 x 0.17	0.53 (.021)	1.52 (.060)	2.49 (.098)	C291170007	FEP jacket
	RD 316	2.6 / 50 D	3 GHz	7 x 0.17	0.53 (.021)	1.52 (.060)	2.80 (.110)	C291185067	FEP jacket
	RG 393	10 / 50 D	11 GHz	7 x 0.81	2.39 (.094)	7.24 (.285)	9.91 (.390)	C291511007	FEP jacket
	RG 400	5 / 50 / D	12.4 GHz	19 x 0.19	0.98 (.039)	2.95 (.116)	4.95 (.195)	C291324007	FEP jacket
Flexible	RD 179	2.6 / 75 D	3 GHz	7 x 0.10	0.30 (.012)	1.6 (.063)	3.07 (.121)	C291230080	LSZH jacket
BT approved	BT 3002	3.6 / 75 D	200 MHz	Solid	0.31 (.012)	1.95 (.077)	3.55 (.140)	C291246046	FEP jacket
	BT 2002	5 / 75 D	200 MHz	7 x 0.20	0.60 (.024)	2.5 (.098)	5.1 (.200)	C291333080	FEP jacket
Semi-rigid	RG 401 /U	.250"	20 GHz	Solid	1.63 (.064)	5.31 (.209)	6.35 (.250)	C291870001	Copper tubing
MIL-C-17	RG 401 alu	.250"	20 GHz	Solid	1.63 (.064)	5.31 (.209)	6.35 (.250)	C291874187	Tinned alu tubing
standard	RG 402 /U	.141"	20 GHz	Solid	0.92 (.036)	2.98 (.117)	3.58 (.141)	C291860001	Copper tubing
	RG 402 tin	.141"	20 GHz	Solid	0.92 (.036)	2.98 (.117)	3.58 (.141)	C291862005	Tinned copper tubing
	RG 402 silver	.141"	20 GHz	Solid	0.92 (.036)	2.98 (.117)	3.58 (.141)	C291861066	Silvered copper tubing
	RG 402 alu	.141"	20 GHz	Solid	0.92 (.036)	2.98 (.117)	3.58 (.141)	C291864187	Tinned alu tubing
	RG402nonm.	.141"	20 GHz	Solid	0.92 (.036)	2.98 (.117)	3.58 (.141)	C291861061	Non magnetic /copper tubing
	RG 405 /U	.085"	20 GHz	Solid	0.51 (.020)	1.68 (.066)	2.20 (.087)	C291850001	Copper tubing
	RG 405 tin	.085"	20 GHz	Solid	0.51 (.020)	1.68 (.066)	2.20 (.087)	C291850005	Tinned copper tubing
	RG 405 alu	.085"	20 GHz	Solid	0.51 (.020)	1.68 (.066)	2.20 (.087)	C291844187	Tinned alu tubing
	RG405nonm.	.085"	20 GHz	Solid	0.51 (.020)	1.68 (.066)	2.20 (.087)	C291851001	Non magnetic / copper tubing
	.047"	.047"	20 GHz	Solid	0.29 (.011)	0.94 (.037)	1.19 (.047)	C291855001	Copper tubing
	.047" tin	.047"	20 GHz	Solid	0.29 (.011)	0.94 (.037)	1.19 (.047)	C291855065	Tinned copper tubing
Hand-formable	Hand-formable	.085"	20 GHz	Solid	0.51 (.020)	1.63 (.064)	2.21 (.087)	C291844065	Tin soaked braid
	Hand-formable	.141"	20 GHz	Solid	0.92 (.036)	2.95 (.116)	3.50 (.138)	C291864065	Tin soaked braid
	Hand-formable	.141"	20 GHz	Solid	0.92 (.036)	2.98 (.117)	4.05 (.159)	C291866378	FEP jacket
	Hand-formable	.141"	20 GHz	Solid	0.92 (.036)	2.98 (.117)	4.50 (.177)	C291866270	LSZH jacket
Corrugated (w/ helical or ringed/ annual copper tube)	Flexible	1/4"		Solid	2.38 (.094)	6.40 (.252)	8.70 (.343)	N/A	Ringed/annular tube
	Flexible	1/2"	8.8 GHz	Solid	4.80 (.189)	11.6 (.457)	16.35 (.644)	C291972085	Ringed/annular tube
	Flexible	7/8"		Solid	9.13 (.359)	22.5 (.866)	27.7 (1.091)	N/A	Ringed/annular tube
	Flexible	1 1/4"		Solid	12.7 (.500)	32.5 (1.28)	39.5 (1.55)	N/A	Ringed/annular tube
	Flexible	1 5/8"		Solid	17.3 (.681)	43.5 (1.71)	50.5 (1.99)	N/A	Ringed/annular tube
	Super flexible	1/4"	20 GHz	Solid	1.90 (.075)	4.70 (.185)	7.40 (.291)	C291993080	Helical tube
	Super flexible	1/4"	12 GHz	Solid	1.90 (.075)	4.40 (.173)	7.70 (.303)	C291993170	Helical tube HCF type
	Super flexible	3/8"	13.4 GHz	Solid	2.60 (.102)	6.30 (.248)	10.8 (.425)	C291996070	Helical tube
	Super flexible	3/8"	11 GHz	Solid	2.60 (.102)	6.30 (.248)	10,1 (.398)	C291996170	Helical tube HCF type
	Super flexible	1/2"	10.2 GHz	Solid	3.60 (.142)	8.70 (.343)	13.2 (.520)	C291994080	Helical tube
	Super flexible	1/2"	11.7 GHz	Solid	3.60 (.142)	8,3 (.327)	13,5 (.531)	C291994170	Helical tube HCF type
	Super flexible	7/8"	5 GHz	Tube	9.04 (.356)	23.62 (.930)	27.48 (1.082)	C291996580	Helical tube

## Notes

This table is intended as a guideline only. For detailed specifications please refer to the relevant standard or to the cable manufacturer's specifications. All dimensions are nominal unless otherwise noted. \*LMR is a registered trademark of Times Microwave Systems.



### COAXIAL CONNECTORS

SERIES		STYLE						ELECTRICAL OPTIONS																				
Name	P/N Series Prefix Radial & Radial AEP	Coupling					Min. Mating Cycles	Main Cable Types					Ω		Frequency								Power (Watt)					
		Press-on	Screw-on	Snap-on	Slide-on	Bayonet Lock		Mini-coax 1mm	RG178	RG316, RG174	RG58, RG59	RG213, RG214	Semi-rigid & Conformable Corrugated	50 Ohms	75 Ohms	1 GHz	2 GHz	4 GHz	8 GHz	12 GHz	18 GHz	27 GHz	40 GHz	65 GHz	@1 GHz	@FMAX		
BMA	R128				■		500/1000		■	■	■			■			22 GHz									450	100 (18GHz)	
BNC HD TV	R140/R141/R142 6500-6999					■	100/500		■	■	■	■		■	◆	◆	■	HD									1000	500
BNC HT	R316					■	500				■			■												1000	700	
BR2	R605					■	500	Twinax style																				
C	R166					■	500			■	■			■			11 GHz									1200	350	
COAXIPACK 2	R694					■	500	■	■					■			6 GHz									40	20	
DIN 7/16	R185/R187		■				500				■	■	■	■			8 GHz									2000	700	
HN	R176		■				500				■			■												1200	850	
IMP	R107	■					20							■			6 GHz									20	8	
MC Card	R199/R299			■			5000	■	■					■			8 GHz									40	14	
Moebius	R199			■			20000	■	■					■			6 GHz									40	14	
MCX	R113/R213			■			500	■	■		■			■	◆		6 GHz									150	60	
MMBX	R223			■			100	■	■					■			12 GHz									100	25	
MMCX	R110			■			500	■			■			■			6 GHz									60	25	
MML	R302	■				■	30	■						■			6 GHz											
MMS	R209			■			50	■	■					■	◆	◆	6 GHz									38	15	
MMT	R210			■			500	■	■					■	◆	◆	8 GHz									38	13	
N/N 18	R161/R162/R163 4000		■				500			■	■	■	■	■	◆	◆	■ 11 GHz	18 GHz								1200	350	
NEX10	R180		■			■	100							■			18 GHz											
QLI	R184					■	100				■	■	■	■			6 GHz									1000W (2GHz)		
QMA	R123					■	100		■	■	■			■			6 GHz									450	180	
QN	R164					■	100			■	■	■	■	■			11 GHz									1000	300	
QRE™	R324			■			100				■			■			12 GHz									450	130	
SBMA	R108			■			500	■	■					■			27 GHz									100	20	

## COAXIAL CONNECTORS

SERIES		STYLE						ELECTRICAL OPTIONS																																			
Name	P/N Series Prefix Radial & Radial AEP	Coupling					Min. Mating Cycles	Main Cable Types						Ω		Frequency								Power (Watt)																			
		Press-on	Screw-on	Snap-on	Slide-on	Bayonet Lock		Mini-coax 1mm	RG178	RG316, RG174	RG58, RG59	RG213, RG214	Semi-rigid & Conformable	Corrugated	50 Ohms	75 Ohms	1 GHz	2 GHz	4 GHz	8 GHz	12 GHz	18 GHz	27 GHz	40 GHz	65 GHz	@1 GHz	@FMAX																
SHV	R317					■	500																							11 GHz											1000	700	
SMA/SMA-COM	R124/R125/R126 9000-9999	■					500		■	■		■																			12 GHz											450	100 (18GHz)
SMA 2.9 (K)	R127	■					500		■	■	■		■																		27 GHz											450	70
SMA 3.5	Limited offering	■																																							450	75	
SMB/SLB	R114/R115/R116 2000-2699		■	■			500		■	■		■																			COM 18 GHz							26 GHz				150	75
SMB-LOCK	R117					■	500		■	■		■																			40 GHz											150	75
SMC	R112/R212 1000-1699	■					500		■	■		■																			34 GHz											150	50
SMP/SMP-COM	R222/R2229		■				100/500/ 1000		■	■		■																														100	15
SMP-LOCK™	R222L					■	500					■																			4 GHz											100	15
SMP-MAX	R222M		■	■			100		■																						10 GHz											500	190
SMPM	R201		■	■			100/1000					■																			COM 12 GHz							40 GHz				60	7
SMZ/Type 43	R214		■			■	250		◆								◆																								150	100	
SSMA	R121/R122	■					500		■			■																			18 GHz											100	20
SSMB/SSLB	R203 7000		■				500																								12 GHz											60	17
SSMC	R202/7000	■					500																								12 GHz											60	17
THT 20/ THT 40	R331/R346	■					500					■																														1500	1500
TNC/TNC 18	R143/R144 6000-6499	■					100/500		■	■	■	■					◆	◆													11 GHz							18 GHz				1000	300
UHF	R155	■					500					■																														1500	1500
UMP	R107	■				■	100	■	■																						6 GHz											60	20
1.85 mm	R327	■					500					■																			67 GHz												
2.4 mm	R327	■					500					■																			50 GHz											150	20
4.3-10	R183	■				■	100					■	■	■	■																6 GHz											700W	
4.1-9.5	R170	■					100					■	■	■																	6 GHz											650W	

◆ 50 Ohms ■ 75 Ohms

### Notes

This table is intended for information only. Some characteristics may change due to different environment/usage. Please consult our Technical Data Sheets.

### INCH/MM CONVERSION CHART

FRACTIONAL (INCH)	DECIMAL (INCH)	MM
	0.0039	0.1000
	0.0079	0.2000
	0.0118	0.3000
1/64	0.0156	0.3969
	0.0157	0.4000
	0.0197	0.5000
	0.0236	0.6000
	0.0276	0.7000
1/32	0.0313	0.7938
	0.0315	0.8000
	0.0354	0.9000
	0.0394	1.0000
1/16	0.0625	1.5875
	0.0787	2.0000
	0.1181	3.0000
1/8	0.1250	3.1750
	0.1969	5.0000

**Notes**

To convert to millimeters: Inches x 25.4  
 To convert to inches: mm x 0.0394

### RADIO BAND DESIGNATIONS

FREQUENCY	DESIGNATION
30 - 300 Hz	ELF
30 - 3000 Hz	ULF
3 - 30 kHz	VLF
30 - 300 kHz	LF
300 - 3000 kHz	MF
3 - 30 MHz	HF
30 - 300 MHz	VHF
300 - 3000 MHz	UHF
3 - 30 GHz	SHF
30 - 300 GHz	EHF

### IEEE RADAR BAND DESIGNATIONS

FREQUENCY	DESIGNATION
1 -2 GHz	L Band
2 -4 GHz	S Band
4 - 8 GHz	C Band
8 - 12 GHz	X Band
12 - 18 GHz	Ku Band
18 - 27 GHz	K Band
27 - 40 GHz	Ka Band
40 - 75 GHz	V Band
75 - 110 GHz	W Band
110 - 300 GHz	mm Band
300 - 3000 GHz	u mm Band

### TABLE OF RETURN LOSS VS. VSWR

VSWR	RETURN LOSS (DB)	TRANS. LOSS (DB)	VOLT. REFL COEFF.	TRANS. POWER (%)	REFL. POWER (%)
1.00	99.9	0.000	0.00	100.0	0.0
1.01	46.1	0.000	0.00	100.0	0.0
1.02	40.1	0.000	0.01	100.0	0.0
1.03	36.6	0.001	0.01	100.0	0.0
1.04	34.2	0.002	0.02	100.0	0.0
1.05	32.3	0.003	0.02	99.9	0.1
1.06	30.4	0.004	0.03	99.9	0.1
1.07	29.4	0.005	0.03	99.9	0.1
1.08	28.3	0.006	0.04	99.9	0.1
1.09	27.3	0.008	0.04	99.8	0.2
1.10	26.4	0.010	0.05	99.8	0.2
1.11	25.7	0.012	0.05	99.7	0.3
1.12	24.9	0.014	0.06	99.7	0.3
1.13	24.3	0.016	0.06	99.6	0.4
1.14	23.7	0.019	0.07	99.6	0.4
1.15	23.1	0.021	0.07	99.5	0.5
1.16	22.6	0.024	0.07	99.5	0.5
1.17	22.1	0.027	0.08	99.4	0.6
1.18	21.7	0.030	0.08	99.3	0.7
1.19	21.2	0.033	0.09	99.2	0.8
1.20	20.8	0.036	0.09	99.2	0.8
1.21	20.4	0.039	0.10	99.1	0.9
1.22	20.1	0.043	0.10	99.0	1.0
1.23	19.7	0.046	0.10	98.9	1.1
1.24	19.4	0.050	0.11	98.9	1.1
1.25	19.1	0.054	0.11	98.8	1.2
1.26	18.8	0.058	0.12	98.7	1.3
1.27	18.5	0.062	0.12	98.6	1.4
1.28	18.2	0.066	0.12	98.5	1.5
1.29	17.9	0.070	0.13	98.4	1.6
1.30	17.7	0.075	0.13	98.3	1.7
1.32	17.2	0.083	0.14	98.10	1.9
1.34	16.8	0.093	0.15	97.90	2.1
1.36	16.3	0.102	0.15	97.70	2.3
1.38	15.9	0.112	0.16	97.50	2.5
1.40	15.6	0.122	0.17	97.20	2.8
1.42	15.2	0.133	0.17	97.00	3.0
1.44	14.9	0.144	0.18	96.70	3.3
1.46	14.6	0.155	0.19	96.50	3.5
1.48	14.3	0.166	0.19	96.30	3.7
1.50	14.0	0.177	0.20	96.00	4.0
1.52	13.7	0.189	0.21	95.70	4.3
1.54	13.4	0.201	0.21	95.50	4.5
1.56	13.2	0.213	0.22	95.20	4.8
1.58	13.0	0.225	0.22	94.90	5.1
1.60	12.7	0.238	0.23	94.70	5.3
1.62	12.5	0.250	0.24	94.40	5.6
1.64	12.3	0.263	0.24	94.10	5.9
1.66	12.1	0.276	0.25	93.80	6.2
1.68	11.9	0.289	0.25	93.60	6.4
1.70	11.7	0.302	0.26	93.30	6.7
1.72	11.5	0.315	0.26	93.00	7.0
1.74	11.4	0.329	0.27	92.10	7.3
1.76	11.2	0.342	0.28	92.40	7.6
1.78	11.0	0.356	0.28	92.10	7.9
1.80	10.9	0.370	0.29	91.80	8.2
1.82	10.7	0.384	0.29	91.50	8.5
1.84	10.6	0.398	0.30	91.30	8.7
1.86	10.4	0.412	0.30	91.00	9.0
1.88	10.3	0.426	0.31	90.70	9.3
1.90	10.2	0.440	0.31	90.40	9.6
1.92	10.0	0.454	0.32	90.10	9.9







## MCX/MMCX/MMS/MMT/MML

R113/R110/R209/R210/R302

**Contents****MML**

Introduction .....	1-4
Characteristics .....	1-4
Pigtails .....	1-5
Cable assemblies .....	1-5 to 1-6
Receptacles .....	1-6
Adapters .....	1-7

**MMS/MMT**

Introduction .....	1-8
Characteristics .....	1-9 to 1-10
Plugs .....	1-11
Pigtails .....	1-11
Cable assemblies .....	1-11 to 1-12
Receptacles .....	1-12
Adapters .....	1-12
Extraction tool .....	1-13
Measurement cable assemblies .....	1-13
Assembly instructions .....	1-13

**MMCX**

Introduction .....	1-14
Interface .....	1-14
Characteristics mmcX .....	1-15
Characteristics eco mmcX .....	1-15
Plugs .....	1-16
Receptacles .....	1-16 to 1-17
Panel drilling .....	1-17
Assembly instructions .....	1-18

**MCX**

Introduction .....	1-19
Interface .....	1-19
Characteristics .....	1-20
Plugs .....	1-21 to 1-22
Jacks .....	1-22
Receptacles .....	1-23 to 1-24
In series adapters .....	1-24
Panel drilling .....	1-25
Packaging .....	1-25
Assembly instructions .....	1-26



## Introduction

Radiall has developed a new MML series to address the market demand for smaller microminiature coaxial connectors for applications such as cell relay, WiFi access points, GPS and other mobile terminals. There are three types of plugs with mated heights of H2.5, H2.0 and H1.5, as well as two types of vertical PCB receptacles with electrical performance up to 6 GHz.

### FEATURES

- Two vertical PCB receptacles
  - MML H2.5 and MML H2.0
  - MML H1.5
- Space saving
  - Three mated heights 2.5 mm, 2.0 mm, 1.5 mm
  - PCB patterns 3.08 mm x 3 mm for H2.5 and H2.0, 2 mm x 2 mm for H1.5
- DC - 6GHz, typical VSWR 1.35 max
- Cable assemblies are offered with three high performance cables: 1.33 mm for MML H2.5, 1.13 mm for MML H2.0, 0.81 mm for MML H1.5

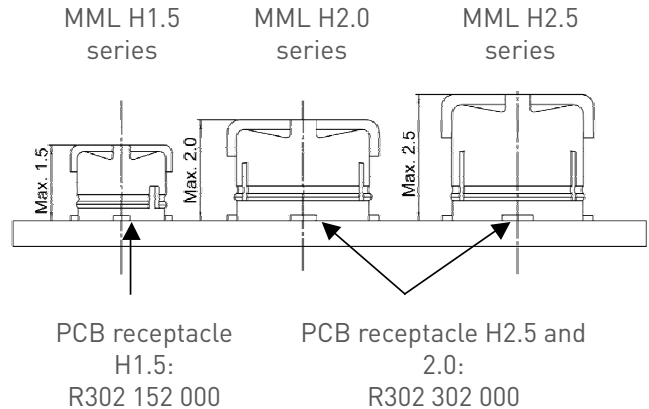

### APPLICATIONS

- Handhelds/GPS/WLAN
- GSM/CDMA/WCDMA/TD-SCDMA cards

## Characteristics

	Values / Remarks
--	------------------

### ELECTRICAL CHARACTERISTICS

Nominal impedance	50Ω
Frequency range	DC - 6 GHz
Typical VSWR	1.35 max
Contact resistance <ul style="list-style-type: none"> <li>• Center contact</li> <li>• Outer contact</li> </ul>	25 mΩ 15 mΩ
Insulation resistance	500 MΩ min
Voltage rating <ul style="list-style-type: none"> <li>• H2.5 and H2</li> <li>• H1.5</li> </ul>	200 Vrms 150 Vrms
Withstanding voltage <ul style="list-style-type: none"> <li>• H2.5 and H2</li> <li>• H1.5</li> </ul>	300 Vrms 200 Vrms
Mechanical durability	30 cycles
Center contact axial force	0.15 N
RoHS	Compliant
Temperature range	-40 / +90°C
Humidity	96 hours at temperature of 40°C and humidity of 95%
Corrosion (salt spray)	5% salt water solution, 48 hours

### MATERIALS AND PLATING

	Material	Plating
Connector bodies	Phosphor Bronze	Gold
Female center contact		
Male center contact	Brass	

Pigtails and Cable Assemblies

MML PIGTAILS

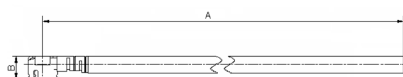

Fig. 1



Fig. 2

Cable group dia.	MML type	Part number	Fig.	Dimensions (mm)	Packaging
				A	
1.33/50/S	H2.5	R302 255 003 xxx	1	xxx (500 mm max)	100
1.13/50/S	H2.0	R302 205 001 xxx	2	xxx (400 mm max)	
0.81/50/S	H1.5	R302 155 000 xxx			

MML to MML CABLE ASSEMBLIES

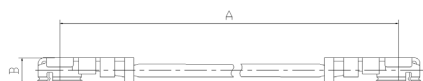

Cable group dia.	MML type	Part number	Dimensions (mm)	Packaging
			A	
1.33/50/S	H2.5	R302 000 000 xxx	xxx (500 mm max)	100
1.13/50/S	H2.0	R302 205 000	100	
0.81/50/S	H1.5	R302 155 001		

MML to SMA PLUG CABLE ASSEMBLIES

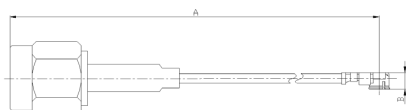
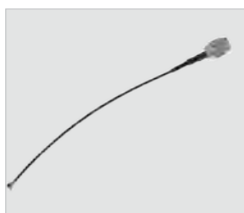

Cable group dia.	MML type	Part number	Dimensions (mm)	Packaging
			A	
1.33/50/S	H2.5	R302 255 002 xxx	xxx (400 mm max)	100
1.13/50/S	H2.0	R302 205 002	100	

Note:  
xxx = length in mm

Length	Step	Tolerance
30 to 100 mm	10 mm	±2 mm
110 to 200 mm		±3 mm
225 to 300 mm	25 mm	±5 mm
325 to 500 mm		±10 mm

Cable Assemblies and Receptacles

**MML to SMA BULKHEAD JACK CABLE ASSEMBLIES**

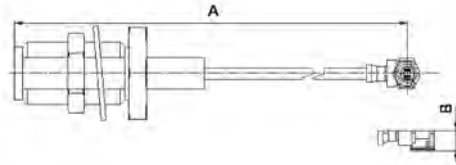
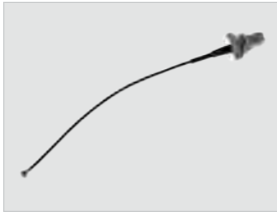

Cable group dia.	MML type	Part number	Dimensions	Packaging	Note
1.37/50/S	H2.5	R302 255 000 xxx	xxx (400 mm max)	100	-
		R302 255 001 xxx			SMA panel seal
1.13/50S	H2.0	R302 205 003 xxx			-
		R302 255 014 xxx			SMA panel seal

Note:

xxx = length in mm

Length	Step	Tolerance
30 to 100 mm	10 mm	±2 mm
110 to 200 mm		±3 mm
225 to 300 mm	25 mm	±5 mm
325 to 500 mm		±10 mm

**MML to RP SMA BULKHEAD REVERSE POLARITY CABLE ASSEMBLIES**

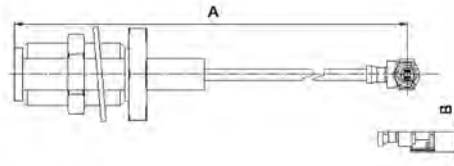
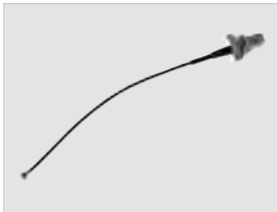

Cable group dia.	MML type	Part number	Dimensions	Packaging	Note
1.37/50/S	H2.5	R302 255 015 xxx	xxx (400 mm max)	100	-
		R302 255 006 xxx			RP SMA panel seal

**SMT RECEPTACLES**

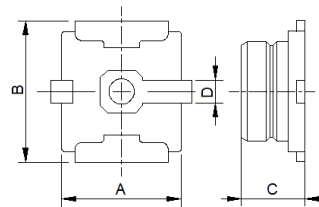

MML type	Part number	Dimensions				Packaging
		A	B	C	D	
H2.5 & H2.0	R302 302 000	2.6	2.6	1.3	0.6	5000 piece / reel
H1.5	R302 152 000	1.7	1.7	0.85	0.3	5000 piece / reel



Adapters and Test Probe

ADAPTERS

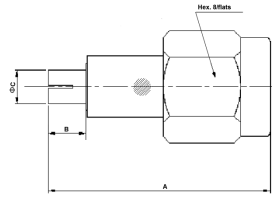

Fig. 1

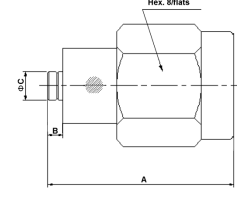
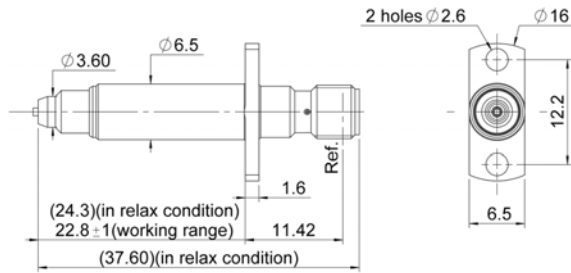

Fig. 2

MML type	Part number	Fig.	Dimensions			Note
			A	B	C	
H2.5 & H2.0	R302 303 000	2	13.2	1.05	1.98	MML plug - SMA plug
	R302 303 001	1	17.2	2.9	2.6	
H1.5	R302 153 000	1	17.2	2.9	2.1	MML jack - SMA plug
	R302 153 001	2	12.9	0.78	1.4	

MML TEST PROBE



Part number	Interface 1	Interface 2
R191 597 800	MML H2.0 / H2.5	SMA female

## Introduction

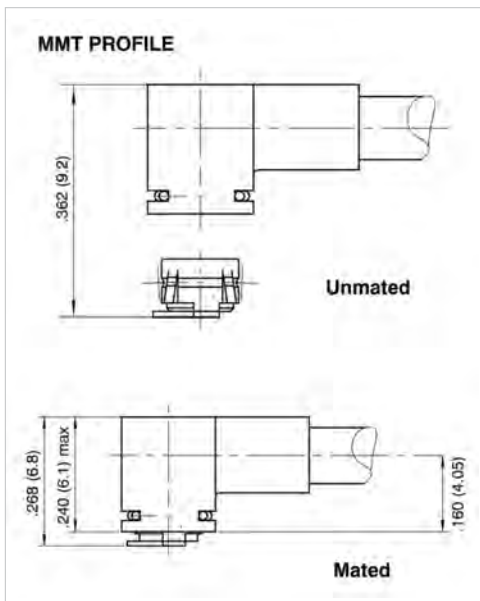
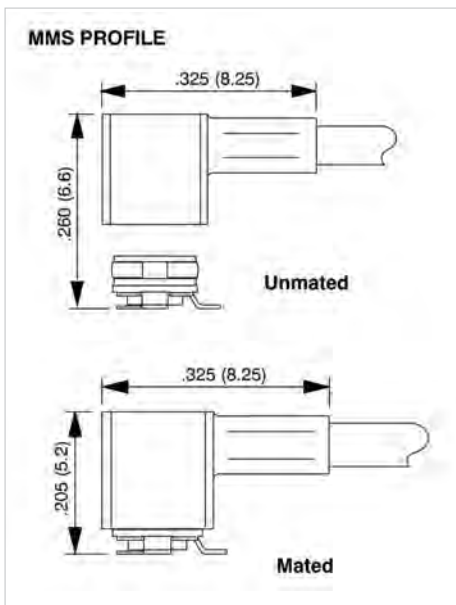

	MMS	MMT
50Ω	DC - 6 GHz	DC - 8 GHz
75Ω	DC - 1 GHz	

### GENERAL

- Low profile coaxial connectors
- Surface-mount receptacle (SMT)
- Snap-on mating
- High RF performance
- 360° cable rotation

### APPLICATIONS

- Automotive
- Satellite reception terminals (GPS...)
- Instrumentation
- Wireless datacom networks
- Automated payment systems
- Video communications
- Other general electronics

Radiall introduced MMS and MMT connectors, dedicated to Surface Mount Technology (SMT), in the 1990s.

MMS and MMT series were the first coaxial connectors truly designed for SMT applications and adapted for automatic pick and place machines.

### • 360° cable rotation

The **MMS** and **MMT** snap-on mating system ensures a correct positive connection each time and all connectors (plugs + receptacles) have a design which allows a 360° rotation of the pair when mated.

### • MMS vs MMT

**MMS** and **MMT** connectors are dedicated to similar applications. The choice between these 2 series will be driven by mating life cycle required for the application. MMS is dedicated to applications which require only a few mating/unmating cycles. MMT provide stronger retention force while allowing more manipulation.

	MMS	MMT
Durability (mating cycle)	50	500
Frequency range	50Ω DC - 6 GHz 75Ω DC - 1 GHz	50Ω DC - 8 GHz 75Ω DC - 1 GHz
Mated height	5.2 mm	6.8 mm

## Characteristics

	Test standard	Values / Remarks
--	---------------	------------------

## ELECTRICAL CHARACTERISTICS

	Test standard	Values / Remarks
Impedance	-	50Ω
Frequency range	-	DC - 6 GHz
Typical V.S.W.R. (mated pair)	IEC 1169-1	75Ω DC - 1 GHz 1.05 at 1 GHz 1.15 at 2.5 GHz 1.35 at 6 GHz
Insertion loss	IEC 1169-1	0.2 dB at 2 GHz
RF leakage (mated pair)	MIL STD 1344 method 3008	-50 dB at 500 MHz -45 dB at 1 GHz -40 dB at 2 GHz
Outer contact resistance	NF-C 93050 (I = 40 mA peak)	5 mΩ max
Center contact resistance	NF-C 93050 (I = 40 mA peak)	15 mΩ max
Insulation resistance	IEC 1169-1	500 MΩ min (under 250 V RMS)
Working voltage	-	50 V RMS
Testing voltage (V RMS)	IEC 1169-1	∅ 1 mm: 250 ; ∅ 2 mm: 500
Maximum admissible power	-	40 W at 1 GHz / 20°C / V.S.W.R. = 1

## MECHANICAL CHARACTERISTICS

	Test standard	Values / Remarks
Durability	IEC 1169-1	50 matings
Force to engage	IEC 1169-1	7 N avg
Force to disengage	IEC 1169-1	5.5 N avg
Shocks (drop test)	IEC 68-2-27	50 g/11 ms ; 3 shocks / axis / way
Random vibrations	General Motors spec.	Sine waves 5 to 1000 Hz 3 to 30g - 1 H/axis
Bumps (mechanical shocks)	IEC 68-2-29	25 g/6 ms 1000 bumps / axis / way
Cable retention force	IEC 1169-1	∅ 1 mm: 20 N ; ∅ 2 mm: 35 N
Solderability	IEC 68-2-54	Passed

## ENVIRONMENTAL CHARACTERISTICS

	Test standard	Values / Remarks
Temperature range	-	-40°C / +90°C
Climatic cycles	GAM T 13	48 H at 70°C - 24 H at 40°C / 93% -36 H at -25°C

## MATERIALS

Bodies plugs/in-series adapters	Die cast zinc / brass
Bodies receptacles	Phosphor bronze
Center contact	Brass
• Male	Beryllium copper
• Female	
Insulator	PTFE

## PLATING

Bodies plugs/in-series adapters	Nickel
Bodies receptacles	Gold
Center contact	Nickel
• Male	Gold
• Female	

## RF LEAKAGE AND V.S.W.R.

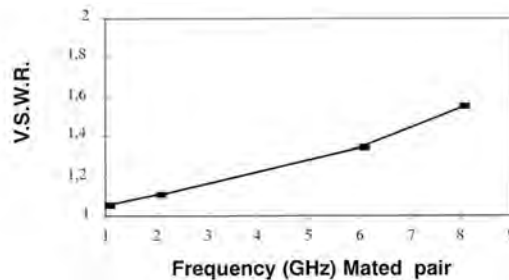
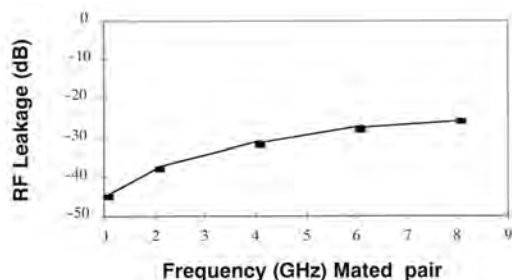



## Characteristics

	Test standard	Values / Remarks
--	---------------	------------------

## ELECTRICAL CHARACTERISTICS

	Test standard	Values / Remarks
Impedance	-	50Ω
Frequency range	-	DC - 8 GHz
Typical V.S.W.R. (mated pair)	IEC 1169-1	75Ω 1.05 at 1 GHz 1.10 at 2.5 GHz 1.15 at 6 GHz
Insertion loss	IEC 1169-1	≤ 0.2 V F (GHz)
RF leakage (mated pair)	IEC 1726	-42 dB at 500 MHz -38 dB at 1 GHz -30 dB at 3 GHz
Outer contact resistance	IEC 1169-1 (I=40 mA eff.)	Initial: 2.5 mΩ max Final: 12.5 mΩ max
Center contact resistance	IEC 1169-1 (I=40 mA eff.)	Initial: 5 mΩ max Final: 15 mΩ max
Insulation resistance	IEC 1169-1	≥ 5000 MΩ under 500 Vcc
Working voltage	-	170 V eff.
Testing voltage	IEC 1169-1	500 V eff.
Maximum admissible power	-	23 W at 1.8 GHz / 40°C / V.S.W.R. = 1.1

## MECHANICAL CHARACTERISTICS

	Test standard	Values / Remarks
Durability	IEC 1169-1	500 matings
Force to engage/disengage	IEC 1169-1	Ins ≤ 18 N Ext > 7 N
Shocks	IEC 68-2-27	Passed
Vibrations	IEC 68-2-6	Passed
Bumps	IEC 68-2-29	Passed
Cable retention force	IEC 1169-1	∅ 2 mm: 20 N ; ∅ 2.6 mm: 60 N
Solderability	IEC 68-2-29	Passed

## ENVIRONMENTAL CHARACTERISTICS

	Test standard	Values / Remarks
Temperature range	-	55°C / 100°C
Damp heat	IEC 68-23	Passed
Thermal shocks	IEC 68-2-14 / Test NA	Passed

## MATERIALS

Plugs body/in-series adaptor	Brass
Receptacles body	CuSn9p
Plugs center contact	Cube2
Receptacles center contact	Brass
Insulators	PTFE, Delrin

## PLATING

Bodies plugs/in series adapters	Nickel / BBR
Bodies receptacles	Gold
Plugs center contact	Gold
Receptacles center contact	Gold

## RF LEAKAGE AND V.S.W.R

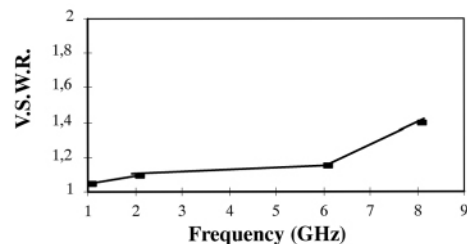
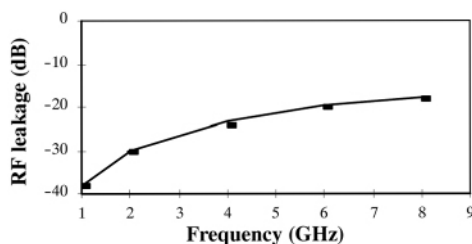

Plugs, Pigtails and Cable Assemblies

**RIGHT ANGLE PLUGS CRIMP TYPE FOR FLEXIBLE CABLES**

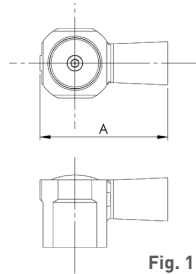
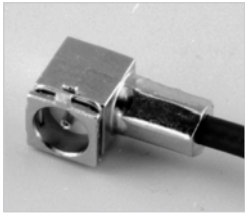

Fig. 1

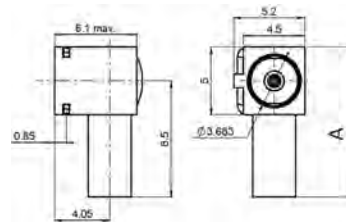

Fig. 2

Series	Cable group	Cable group dia.	Part number	Fig.	Imp. (Ω)	Dimensions A (mm)	Captive center contact	Finish
MMS	RG178 / RG196	2/50/S	R209 353 000	1	50	8.25	Yes	Nickel
		1/50/S	R209 351 020			7.2		
MMT	RG178 / RG196	2/50/S	R210 160 020	2	50	11		
	RG174 / RG316	2.6/50/S	R210 157 010			10		

**PIGTAILS**

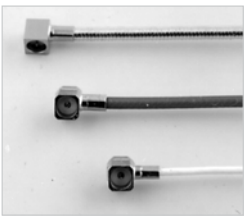

Fig. 1

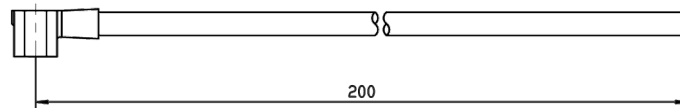
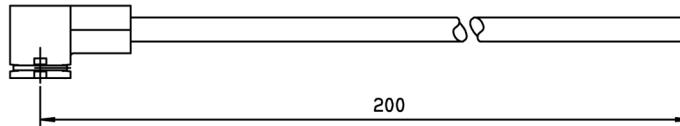

Fig. 2



Series	Cable group	Cable group dia.	Part number	Fig.	Composition
MMS	RG178 / RG196	2/50/S	R285 001 021	1	R209 353 000 + C291 145 007
MMT	RG178 / RG196	2/50/S	R284 008 001	2	R210 160 020 + C291 145 007
	RG174 / RG316	2.6/50/S	R284 008 004		R210 157 010 + C291 150 000

**CABLE ASSEMBLIES**

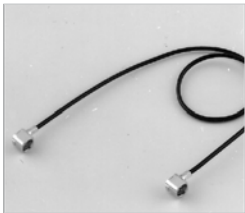

Fig. 1

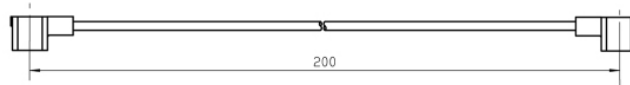
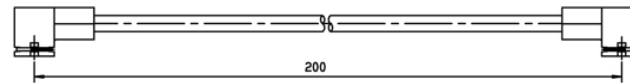

Fig. 2



Series	Cable group	Cable group dia.	Part number	Fig.	Composition
MMS	-	1/50/S	R285 004 001	1	R209 351 020 + R291 050 066 + R209 351 020
	RG178 / RG196	2/50/S	R285 004 221		R209 353 000 + C291 145 007 + R209 353 000
MMT	RG178 / RG196	2/50/S	R285 011 221	2	R210 160 020 + C291 145 007 + R210 160 020

All dimensions are given in mm.

MMS/MMT

Cable Assemblies, Receptacles and Adapters

CUSTOM CABLE ASSEMBLIES

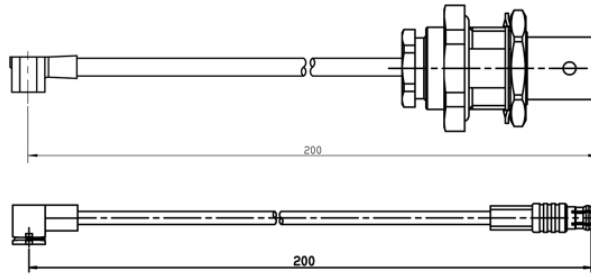

Contact us for all your cable assembly needs.

SMT RECEPTACLES

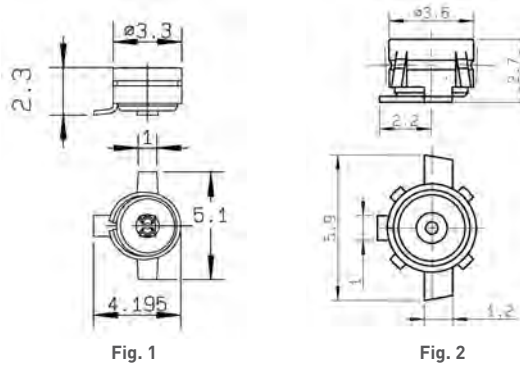

Series	Part number	Fig.	Imp. (Ω)	Center contact finish	Finish	Packaging	Reel dia.
MMS	R209 408 012	1	50	Gold	Gold	Tape & Reel 100 pieces	180
	R209 408 052					Tape & Reel 500 pieces	180
	R209 408 302					Tape & Reel 3000 pieces	330
MMT	R210 408 012	2	50	Gold	Gold	Tape & Reel 100 pieces	180
	R210 408 052					Tape & Reel 500 pieces	180
	R210 408 302					Tape & Reel 3000 pieces	330

ADAPTERS

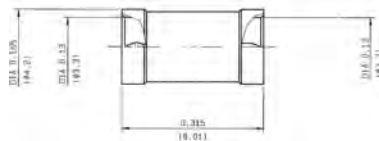
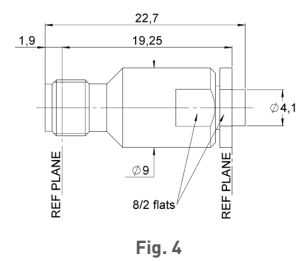
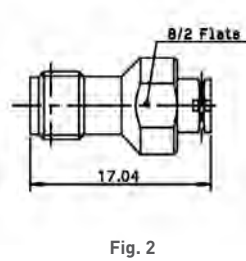
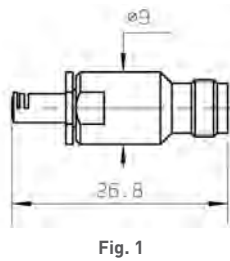

Series	Part number	Fig.	Type	Finish
MMS	R191 975 791	1	MMS female / SMA female	Passivated stainless steel
	R191 975 781	-	MMS male / SMA female	
	R209 703 070	3	MMS male / MMS male	Ni
MMT	R191 394 027	2	MMT female / SMA female	BBR

Measurement Cable Assemblies and Tooling

MEASUREMENT CABLE ASSEMBLIES

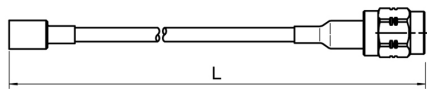

Fig. 1

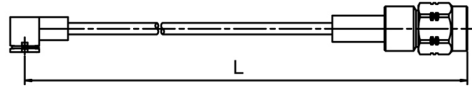
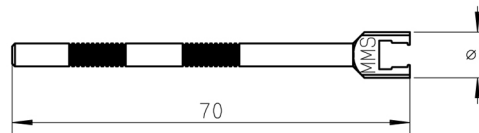

Fig. 2

Series	Cable group	Cable group dia.	Part number	Fig.	Composition	Length L (mm)
MMS <sup>(1)</sup>	RG178 / RG196	2/50/S	R284 007 013	1	R209 080 500 + C291 145 007 + R124 069 120	150
MMT	RD316	2.6/50/D	R285 024 071	2	R210 158 010 + C291 185 067 + R124 072 220	200

<sup>(1)</sup> Both cable assemblies are equipped with a straight MMS plug with a sliding interface to allow 500 matings and a SMA connector.

EXTRACTION TOOL



Materials and finish: black anodized aluminium  
The anodization allows the electric insulation and protects from the oxidation.

Series	Part number
MMS	R282 868 100
MMT	R282 868 040

Procedure for use of SMT Nozzle for Receptacle

Ø OF NOZZLE > 1.2 mm  
Suction with the central contact hole.

Ø OF NOZZLE < 1.2 mm  
Suction with insulator.

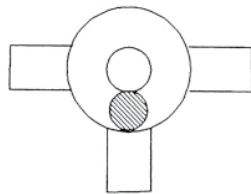
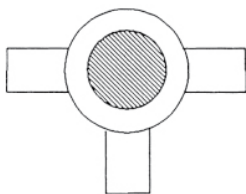

ASPIRATION AREA

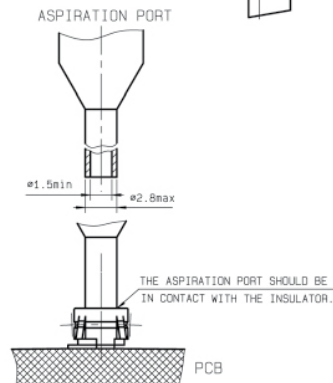
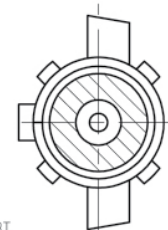



Introduction

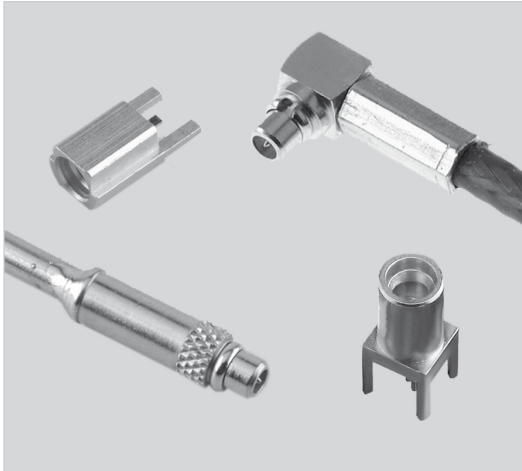

50 Ω	DC - 6 GHz
------	------------

GENERAL

- Subminiature coaxial connectors
- Push-pull snap-on mating
- Complies with specification CECC 22000

APPLICATIONS

- Wireless telecom
- PCMCIA cards
- RF test ports
- Medical

MMCX series is dedicated for wire to PCB connection where low space above the PCB is available (less than 2.1 mm). MMCX is adapted to high volume applications and Pick & Place manufacturing processes.

Interface

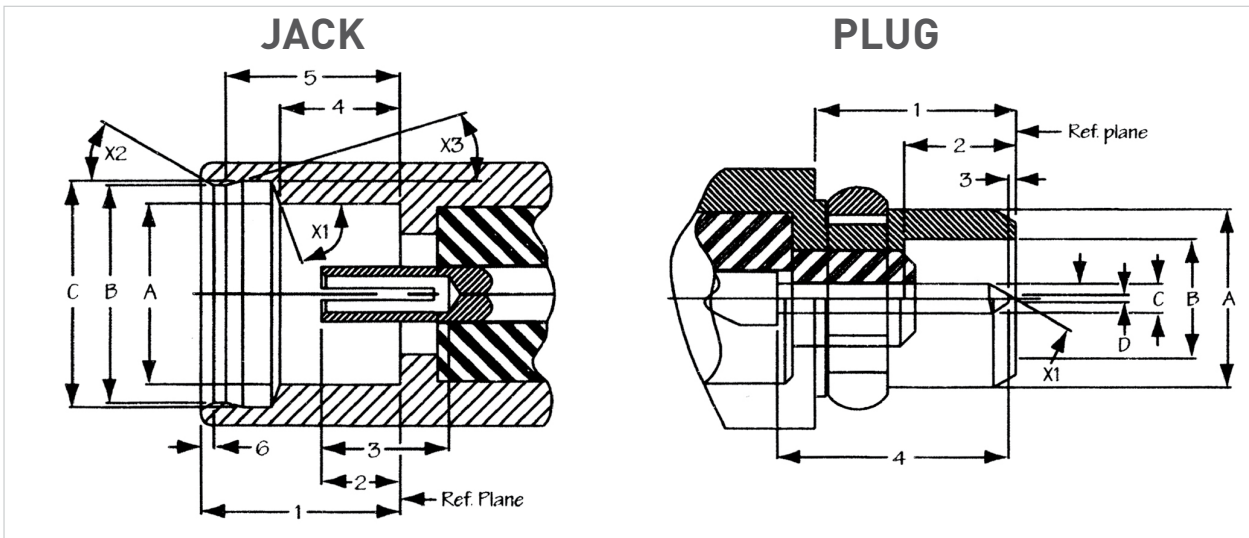

Letter	mm		inch	
	min.	max.	min.	max.
1	2.60	-	.102	-
2	0.90	1.20	.035	.047
3	1.40	-	.055	-
4	1.57	1.63	.062	.064
5	2.30	2.34	.091	.092
6	-	0.23	-	.009
A	2.41	-	.095	-
B	2.88	2.90	.113	.114
C	3.00	3.04	.118	.120
X1	68°	72°	-	-
X2	28°	32°	-	-
X3	13°	17°	-	-

Letter	mm		inch	
	min.	max.	min.	max.
1	2.70	-	.106	-
2	1.45	-	.057	-
3	0	0.25	-	.010
A	2.40	-	.095	-
B	1.58	1.62	.062	.064
C	0.38	0.42	.015	.017
D	-	0.20	-	.008
X1	29°	31°	-	-

**Characteristics**

	Test standard	Values / Remarks
<b>ELECTRICAL CHARACTERISTICS</b>		
Impedance	-	50Ω
Frequency range	-	DC - 6 GHz
V.S.W.R.	CECC 22000 4.4.1	Edge card SMT: 1.40 max Cabled: 1.35 max
Dielectric withstanding voltage (at sea level)	CECC 22000 4.4.5	500 V RMS 50 Hz
Insulation resistance	CECC 22000 4.4.4	1000 MΩ min

**MECHANICAL CHARACTERISTICS**

Engagement force	CECC 22000 4.5.4	3.5 lbs max
Disengagement force	CECC 22000 4.5.4	1.4 lbs to 3.4 lbs max
Contact captivation	CECC 22000 4.5.2	2.3 lbs min
Durability (mating)	CECC 22000 4.7.1	500 cycles min

**ENVIRONMENTAL CHARACTERISTICS**

Temperature range	-	-55°C / +155°C
Temperature shock	CECC 22000 4.6.7	compliant
Vibration	CECC 22000 4.6.3	compliant

**MATERIALS AND PLATING**

	Material	Plating
Bodies	Brass	Gold
Center contact • Male • Female	Brass Beryllium copper	Gold
Insulator	PTFE	-

These characteristics are typical and may not apply to all connectors.

**Characteristics Eco MMCX****ELECTRICAL AND MECHANICAL CHARACTERISTICS**

Impedance	50Ω
Frequency range	DC - 3 GHz
Typical VSWR	1.35 at 3 GHz
Temperature range	- 40°C / + 85°C
Mating cycles	100 mating cycles

**MATERIALS AND PLATING**

	Material	Plating
Connector body	Brass	Gold
Insulator	PTFE / Polypropylene	-
Female center contact	Beryllium copper	Gold
Outer contact	Brass	-

**PACKAGING**

Packaging	100 pieces bulk 500 pieces reel 1500 pieces reel Unit packaging
-----------	--

## Plugs and Receptacles

### STRAIGHT PLUGS

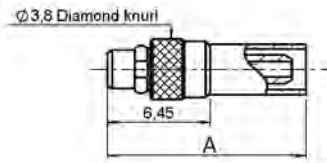

Cable group	Cable group dia.	Part number	Dimensions A (mm)	Packaging	Note
RG178 / RG196	2/50/S	R110 081 020	12.45	100	Full crimp type
RG174 / RG176	2.6/50/S	R110 083 120	13.35		

### RIGHT ANGLE PLUGS

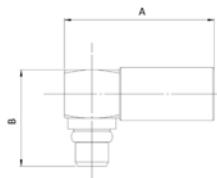

Cable group	Cable group dia.	Part number	Dimensions (mm)		Packaging	Note
			A	B		
RG178 / RG196	2/50/S	R110 170 100	10.9	7	100	-
		R110A 170 100	11	9.1	1000	ECO version
RG174 / RG316	2.6/50/S	R110 172 100	10.9	7	100	-
		R110A 172 100	12.5	8	1000	ECO version
RG405	.085"	R110 153 000	7	7	100	Solder type

### PCB EDGE CARD RECEPTACLES

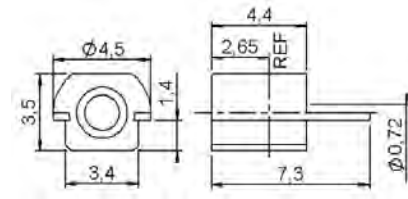

Part number	Gender	Assembly instructions	Packaging	Note
R110 422 100	Jack	M03	100	SMT
R110A 422 830			Tape & Reel of 1500 pieces	ECO version

### STRAIGHT PLUG RECEPTACLES

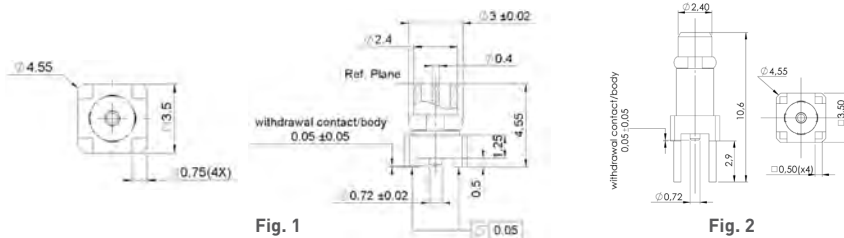

Part number	Fig.	Assembly instructions	Panel Drilling	Packaging	Note
R110 434 100	2	-	P01	100	PCB
R110 434 860	1	M04	-	Tape & Reel of 500 pieces	SMT

Receptacles and In Series Adapters

STRAIGHT JACK RECEPTACLES

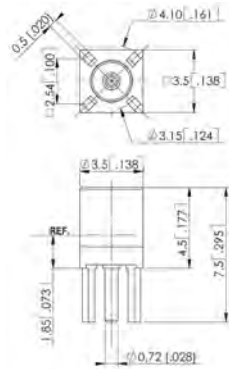

Fig. 1

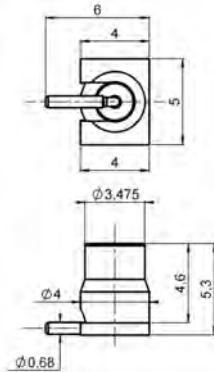

Fig. 2

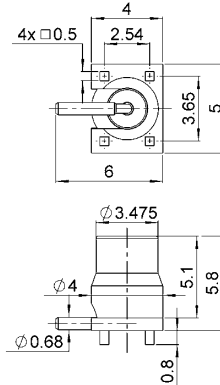

Fig. 3

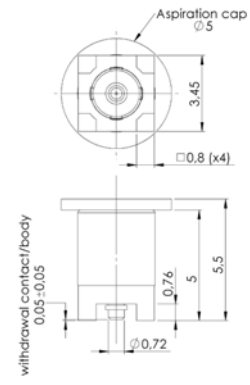
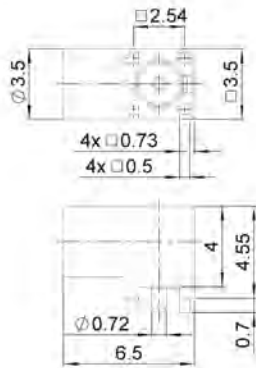

Fig. 4

Part number	Fig.	Panel drilling	Assembly instructions	Packaging	Note
R110 426 000	1	P01	-	100	Solder legs
R110A 426 000					ECO version
R110 427 810	4	-	-	500	SMT
R110 427 820	2	-	M01	Tape & Reel of 500 pieces	
R110A 427 830	3	-	M02		ECO version

RIGHT ANGLE JACK RECEPTACLE



Part number	Panel drilling	Packaging
R110 665 860	P02	500

IN SERIES ADAPTER

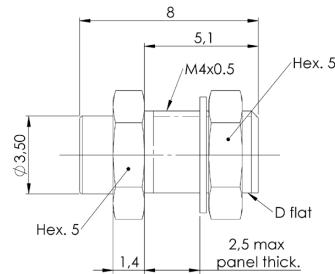

Part number	Type	Finish
R110 704 103	Female to Female	Gold

Panel Drilling

P01

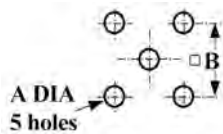

	mm		inch	
	max.	min.	max.	min.
A	0.85	0.75	.033	.030
B	2.56	2.52	.101	.099

P02

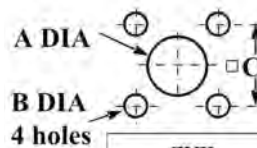

	mm	
	Maxi	mini
A	1.05	0.95
B	0.9	0.8
C	2.56	2.52



## Assembly Instructions

### M01

#### SOLDERING PATTERN

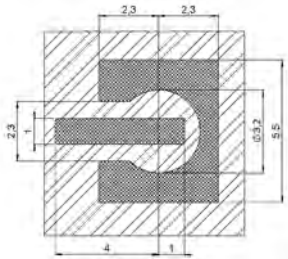

**Part number**  
R110 427 820

Ground + varnish  
 Lands for solder paste

#### VIDEO SHADOWS

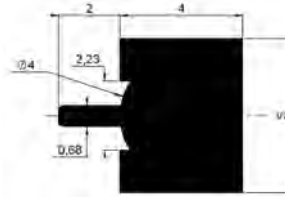

### M02

#### SOLDERING PATTERN

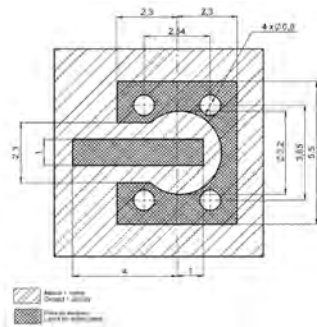

**Part number**  
R110A 427 830

#### VIDEO SHADOWS

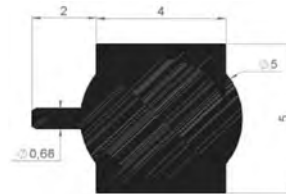

### M03

#### SOLDERING PATTERN

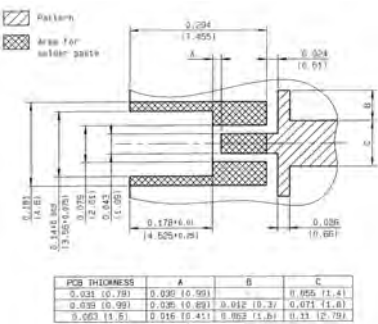

**Part number**  
R110 422 100  
R110A 422 830

#### VIDEO SHADOWS

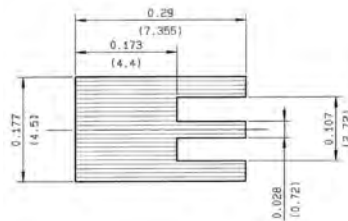

### M04

#### SOLDERING PATTERN

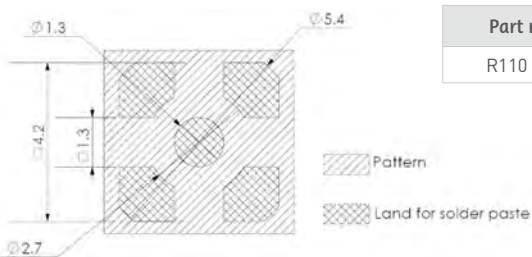

**Part number**  
R110 434 860

Introduction

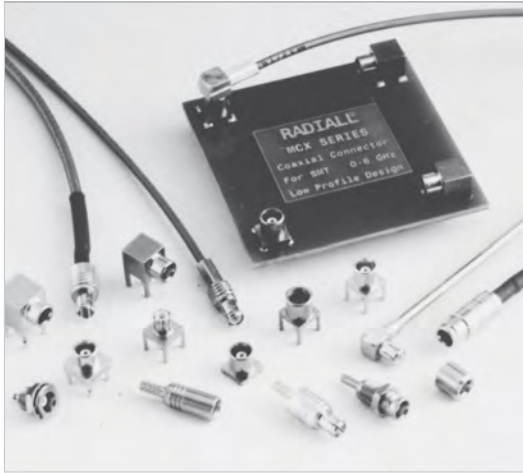

50Ω - 75Ω	DC - 6 GHz
-----------	------------

**GENERAL**

- Subminiature coaxial connectors
- Push-pull snap-on mating
- Complies with specification CECC 22220
- CEI standard 1169-36

**APPLICATIONS**

**50Ω models**

- Wireless communications
- Civil and military radio-telecommunication equipment

**75Ω models**

- Video communication
- Television broadcasting

The MCX series utilizes the SMB series electrical line and features a particularly simple, compact and robust interface. The MCX series is 30% smaller than the SMB. The MCX series helps to **miniaturize equipment**. It lowers wiring connection costs through its full crimp and solder crimp versions as the center contact of the straight models can be either crimped or soldered. It optimizes PCB layouts with its range of models for PCBs including surface mount and press-fit receptacles.

Interface

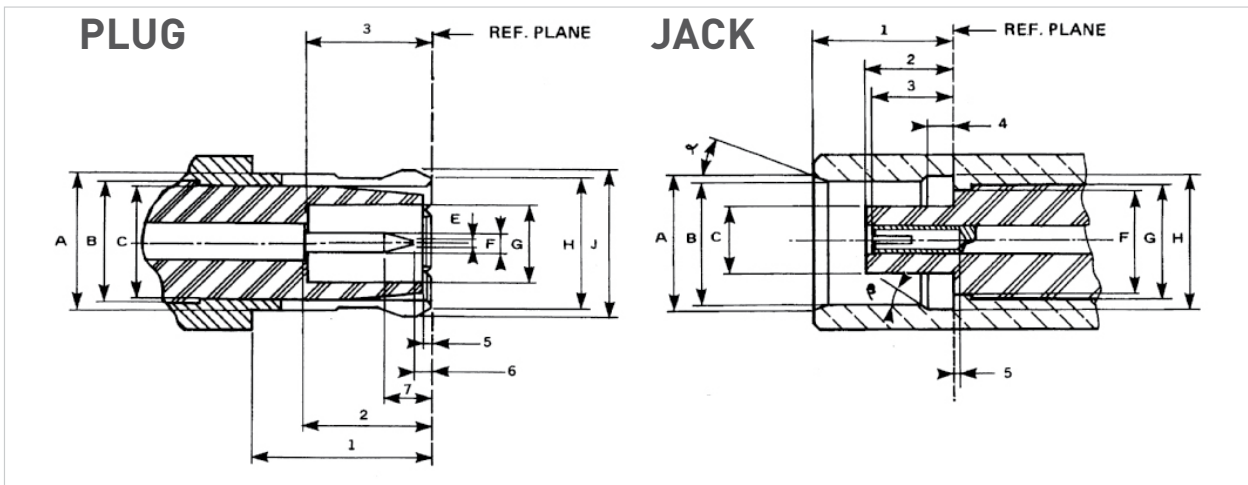

ITEM	mm		inch	
	min.	max.	min.	max.
1	4.15	-	.163	-
2	2.80	3.20	.110	.126
3	2.80	-	.110	-
5	0	0.30	0	.012
6	0.15	-	.006	-
7	-	1.20	-	.047
A	-	3.40	-	.134
B	3.05 nom.		.120 nom.	
C	-	3.00	-	.118
E	-	0.25	-	.010
F	0.48	0.53	.019	.021
G	2.00	-	.079	-
H	-	3.60	-	.142
J	-	3.80	-	.150

ITEM	mm		inch	
	min.	max.	min.	max.
1	4.00	4.12	.157	.162
2	2.60	2.80	.102	.110
3	2.30	2.80	.090	.110
4	0.75	0.85	.029	.033
5	0	-	0	-
a	18°	22°	18°	22°
β	43°	47°	43°	47°
A	3.80	-	.150	-
B	3.42	3.48	.135	.137
C	-	1.98	-	.078
F	-	3.00	-	.118
G	3.05 nom.		3.05 nom.	
H	3.60	3.75	.142	.148

## Characteristics

Test / Characteristics	Values / Remarks		
<b>ELECTRICAL CHARACTERISTICS</b>			
Impedance	50Ω and 75Ω		
Frequency range	DC - 6 GHz		
Typical V.S.W.R. • Straight styles: .085 2.6/50/S • Sight angle styles: .085 2.6/50/S	1 GHz 1.04 1.06 1.03 1.04	2.5 GHz 1.08 1.09 1.06 1.07	6 GHz 1.13 1.12 1.10 1.10
Insulation resistance	1 000 MΩ		
Contact resistance (mΩ) • Center contact • Outer contact	Initial ≤ 5 ≤ 2.5	After environment ≤ 15 ≤ 7.5	
Voltage rating (V.R.M.R.) • Cable RG 196/U - RG 188A/U - .047" • ∅ 2.6 double screen • RG 405/U - .085	At sea level 170 V rms max 335 V rms max 250 V rms max		At 70.000 Ft 45 V rms max 85 V rms max 65 V rms max
Dielectric withstanding voltage • Cable RG 196/U - RG 188A/U - .047" • ∅ 2.6 double screen • RG 405/U - .085	At sea level 500 V rms max 750 V rms max 750 V rms max		At 70.000 Ft 100 V rms max 100 V rms max 100 V rms max
Power	P = 120W at 1.8 GHz, T = 40°C at sea level, VSWR = 1.1 for a straight plug MCX for [ 2.6/50/D cable		

## MECHANICAL CHARACTERISTICS

Mechanical endurance	500 matings
Engagement Separation force	≤ 14.2 lbs - 63 N max ≥ 1.8 Lbs - 8N ≤ 4.5 lbs 20 N
Cable retention force • RG 196A/U • RG 188A/U • ∅ 2.6/50 Ω double screen • .047" • RG 405/U-.085	≥ 7.2 lbs - 32 N ≥ 11.9 lbs - 53 N ≥ 24.1 lbs - 107 N ≥ 9.7 lbs - 43 N ≥ 34.9 lbs - 155 N
Contact captivation	Axial force 2.25 Lbs 10 N

## ENVIRONMENTAL CHARACTERISTICS

Operating temperature	-55°C +155°C
Temperature cycling	CECC 22220 paragraph 4-6-5
Thermal shock	CECC 22220 paragraph 4-6-7
High temperature test	CECC 22220 paragraph 4-7-2
Corrosion (salt spray)	CECC 22220 paragraph 4-6-10
Vibration	CECC 22220 paragraph 4-6-3

## MATERIALS AND PLATING

	Material	Plating
Bodies and male contacts	Brass	Gold / BBR (bodies)
Female center contacts	Beryllium copper	Gold
Ferrules	Brass	-
Insulators	PTFE	-

All dimensions are given in mm.  
Standard packaging = 100 pieces

## Plugs

## STRAIGHT PLUGS, FULL CRIMP TYPE, FOR FLEXIBLE CABLES

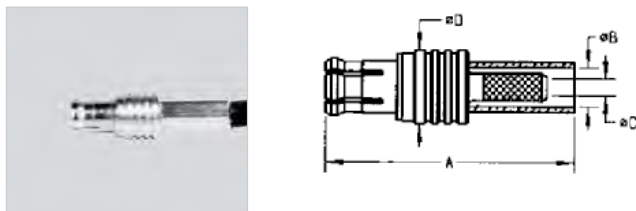

Cable group	Cable group dia.	Part number	Imp. ( $\Omega$ )	Dimensions (mm)				Captive center contact	Finish
				A	B	C	D		
RG178 / RG196	2/50/S	R113 081 000	50	16.1	2.55	1.1	5	No	Gold
RG174 / RG316	2.6/50/S	R113 082 000		16.1	2.95	1.65			
RD316	2.6/50/D	R113 083 000		16.2	3.25	1.65			
RG179	2.6/75/S	R213 082 007	75	18.2	2.95	1.7	5.8	Yes	BBR
RD179	2.6/75/D	R213 083 007		18.3	3.25				

## STRAIGHT PLUGS, SOLDER TYPE, FOR SEMI-RIGID CABLES

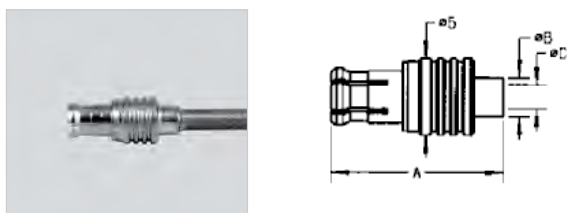

Cable group	Cable group dia.	Part number	Imp. ( $\Omega$ )	Dimensions (mm)			Captive center contact	Finish
				A	B	C		
RG405	.085"	R113 053 000	50	11.3	3	2.25	No	Gold
UT085-75	.085"/75	R213 053 037	75	14.1	3.1	2.3		BBR

## RIGHT ANGLE PLUGS, CRIMP TYPE, FOR FLEXIBLE CABLES (captive center contact)

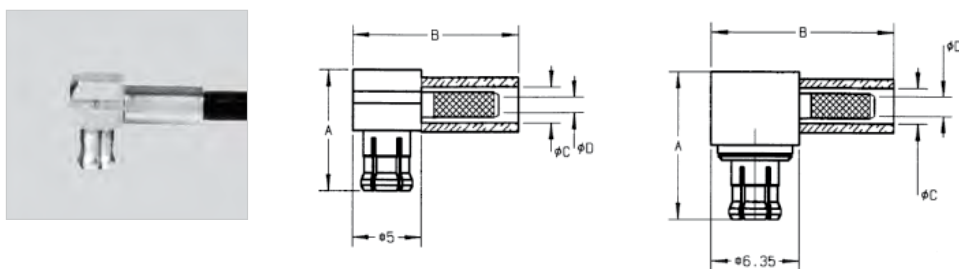

Fig. 1

Fig. 2

Cable group	Cable group dia.	Part number	Fig.	Imp. ( $\Omega$ )	Dimensions (mm)				Finish
					A	B	C	D	
RG178 / RG196	2/50/S	R113 181 000	1	50	8.6	11.9	2.55	1.1	Gold
RG174 / RG316	2.6/50/S	R113 182 000					2.95	1.65	
		R113 182 020			8.2	11.1	3.1	1.7	Gold
RD316	2.6/50/D	R113 183 000					8.6	11.9	
RG179	2.6/75/S	R213 182 007	2	75	10.6	13.3	2.95	1.7	
RD179	2.6/75/D	R213 183 007					3.25		



Plugs and Jacks

**RIGHT ANGLE PLUGS, SOLDER TYPE (captive center contact)**

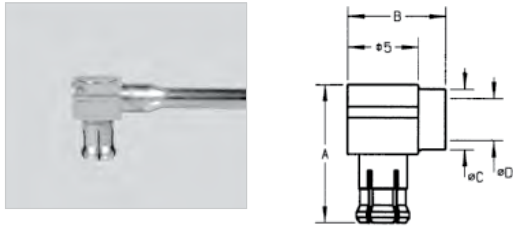

Cable group	Cable group dia.	Part number	Imp. (Ω)	Dimensions (mm)				Finish
				A	B	C	D	
.047" semi-rigid	.047"	R113 151 000	50	8.6	7	2.1	1.25	Gold
RG405	.085"	R113 153 000				3.1	2.25	
RG178 / RG174 / RG405	2/50/S - 2.6/50/S - .085"	R113 161 000		8	8	3.0	2.35	

**STRAIGHT JACKS, FOR FLEXIBLE AND SEMI-RIGID CABLES**

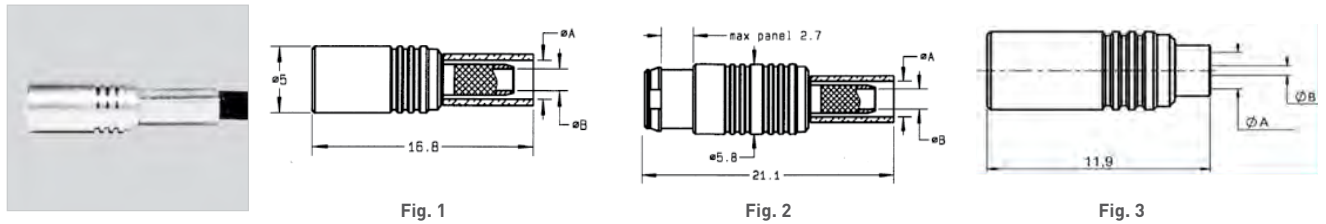

Cable group	Cable group dia.	Part number	Fig.	Imp. (Ω)	Dimensions (mm)		Captive center contact	Panel drilling	Finish
					A	B			
RG174 / RG316	2.6/50/S	R113 240 000	1	50	2.95	1.65	Yes	-	Gold
RG179	2.6/75/S	R213 238 007	2	75	2.95	1.7		P01	Clip-on panel mount
RG405	.085"	R113 223 000	3	50	2.25	0.6	No	-	Gold

**STRAIGHT BULKHEAD JACKS, FOR FLEXIBLE AND SEMI-RIGID CABLES**

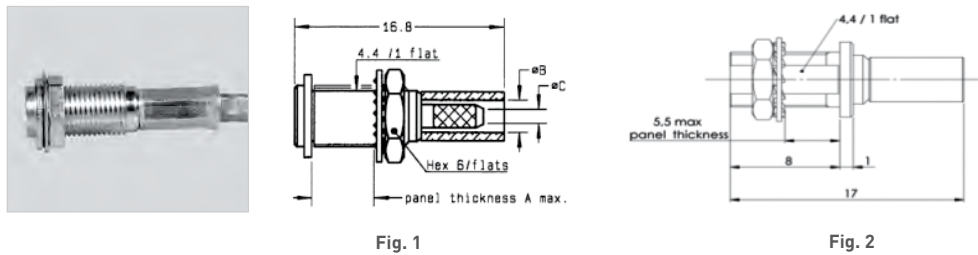

Cable group	Cable group dia.	Part number	Imp. (Ω)	Dimensions (mm)			Captive center contact	Panel drilling	Finish
				A	B	C			
RG174 / RG316	2.6/50/S	R113 310 000	50	5	2.95	1.65	Yes	P02	Gold
RG178 / RG196	2/50/S	R113 306 000			2.55	1.1	No		
RG405	.085"	R113 303 000			2.25	0.6			
RG174 / RG196	2.6/50/S	R113 312 000			2.95	1.65	Yes		

Receptacles

**STRAIGHT FEMALE PANEL RECEPTACLES (captive center contact)**

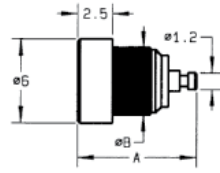

Fig. 1

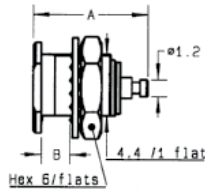
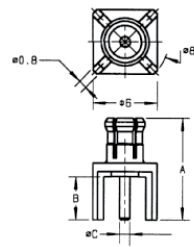

Fig. 2

Part number	Fig.	Imp. ( $\Omega$ )	Dimensions (mm)		Panel drilling	Finish	Note
			A	B			
R113 402 220	1	50	8.7	4.8	P03	BBR	Press-in mount
R113 553 000	2		8.65	2.5	P02	Gold	Recessed front mount

**STRAIGHT MALE PCB RECEPTACLES (captive center contact)**



Part number	Imp. ( $\Omega$ )	Dimensions (mm)			Panel drilling	Finish
		A	B	C		
R113 425 000	50	9.65	4.1	0.98	P04	Gold

**STRAIGHT FEMALE PCB RECEPTACLES (captive center contact)**

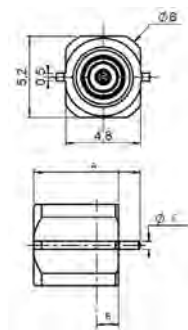

Fig. 1

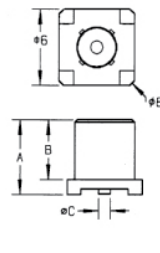

Fig. 2

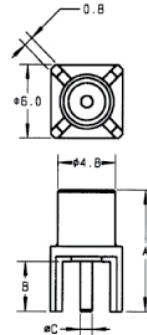

Fig. 3

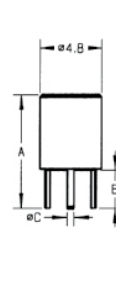

Fig. 4

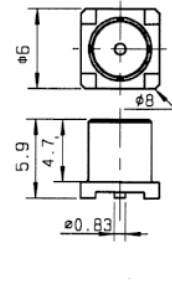
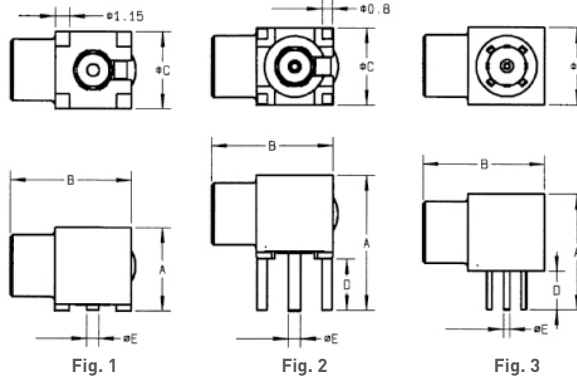

Fig. 5

Part number	Fig.	Imp. ( $\Omega$ )	Dimensions (mm)			Assembly instructions	Panel drilling	Finish	Note
			A	B	C				
R113 423 000	1	50	6.9	1.4	0.5	M01	-	Gold	SMT / Edge-card
R113 424 000	2		5.9	4.7	0.96				SMT
R113 424 010									SMT / Tape & Reel 100 pieces
R113 424 020									SMT / Tape & Reel 500 pieces
R113 426 000	3		10	4.1	0.98				-
R113 427 000	4	9	3	0.5	-	P05	Gold	Space saving on PCB	
R213 424 800	5	75	-	-	-	-	Gold	SMT / Tape & Reel 100 pieces	

Receptacles and In Series Adapters

**RIGHT ANGLE FEMALE PCB RECEPTACLES (captive center contact)**



Part number	Fig.	Imp. (Ω)	Dimensions (mm)					Assembly instructions	Panel drilling	Finish	Note
			A	B	C	D	E				
R113 664 000	1	50	6.5	9.5	6	-	0.96	M01	-	Gold	SMT
R113 665 000	2		10.5			4		-	-	P04	BBR
R113 665 020	2		9	9.4		3	0.5	P05	Space saving pattern		
R113 666 000	3	75	6.5	9.5	6	-	0.83	M01	-	Gold	SMT / Tape & Reel 100 pieces
R213 664 800	1		10.5			4		0.83	-	P04	-
R213 665 000	2		10.5	4		0.83	-	P04	-		

**IN SERIES ADAPTER (female - female)**

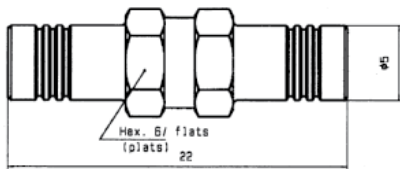

Part number	Imp. (Ω)	Finish
R113 704 000	50	Gold

Panel Drilling

P01

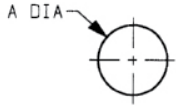

A	MM		INCH	
	maxi	mini	maxi	mini
A	5	4.97	0.197	0.196

P02

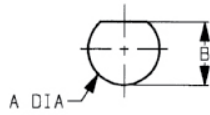

	MM		INCH	
	maxi	mini	maxi	mini
A	5	4.9	0.197	0.19
B	4.58	4.46	0.18	0.176

P03

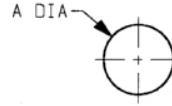

A	MM		INCH	
	maxi	mini	maxi	mini
A	4.77	4.74	0.188	0.187

P04

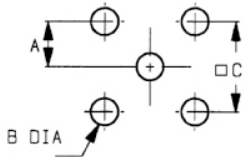

A	MM		INCH	
	maxi	mini	maxi	mini
A	2.56	2.52	0.101	0.099
B	1.4	1.3	0.055	0.051
C	5.13	5.03	0.202	0.198

P05

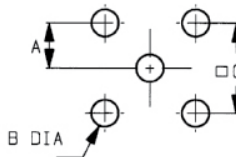

A	MM		INCH	
	maxi	mini	maxi	mini
A	1.30	1.24	.051	.049
B	0.89	0.79	.035	.031
C	2.59	2.49	.102	.098

Packaging

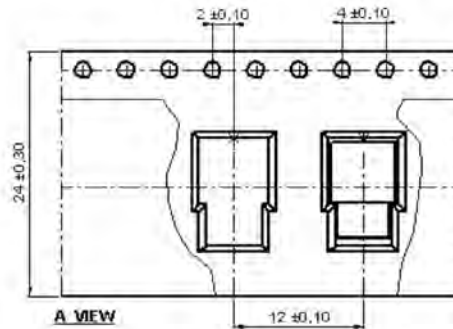
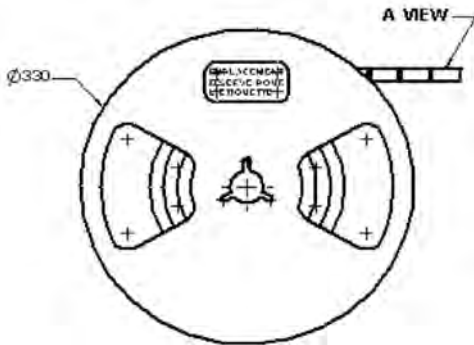



Assembly Instructions

**M01**

Part number
R113 423 000

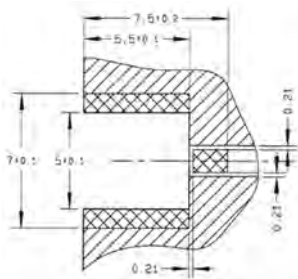

Part number	a	b	c
R113 424 000 R113 424 010 R113 424 020	R113A 424 020 R113 664 000	∅ 1.7 $\begin{smallmatrix} +0.1 \\ 0 \end{smallmatrix}$	1.2 0.21
R113A 664 120		∅ 1.05	1.2 0.21
R213 424 800		∅ 1.57 $\begin{smallmatrix} +0.1 \\ 0 \end{smallmatrix}$	1 0.63

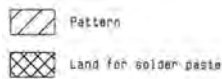
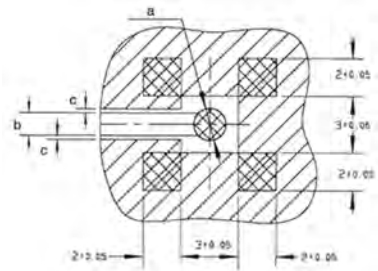

**COPLANAR LINE**

Pattern and signal are on the same side.  
 Thickness of PCB: .063 (1.6 mm).  
 The material of PCB is the epoxy resin of glass fabrics bacs (Er = 4.8).  
 The solder resist should be printed.

**VIDEO SHADOW**

Part number
R113 423 000

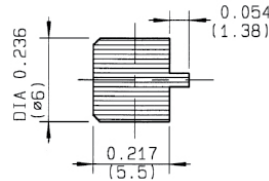

Part number	
R113 424 000 R113 424 010	R113 424 020 R113A 424 020 R213 424 800

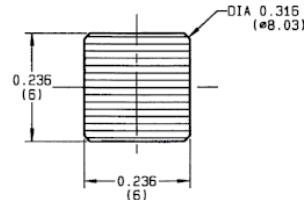

Part number	
R113 664 000 R113A 664 120	R213 664 800

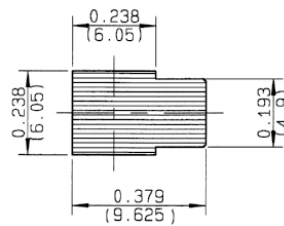

Aspiration nozzle dimensions  
**MCX 50Ω**      **MCX 75Ω**

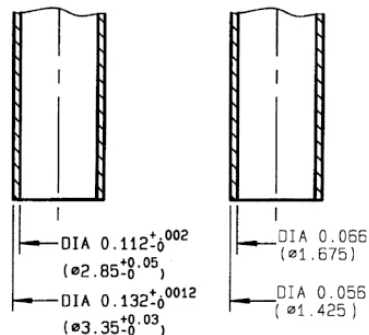



## SMPM/SMP/SMP-LOCK™/SMP-COM

R201/R222/R222L/R2229

**Contents****SMPM**

Introduction .....	2-4
Interface .....	2-5
Characteristics .....	2-6
Plugs and Jacks .....	2-7
Receptacles and panel shrouds .....	2-8 to 2-9
Adapters .....	2-9 to 2-10
Panel drilling .....	2-10 to 2-11
Assembly instructions .....	2-11

**SMP**

Introduction .....	2-4
Interface .....	2-12 to 2-13
Characteristics .....	2-14
Plugs and jacks .....	2-15 to 2-16
Receptacles .....	2-16 to 2-20
Panel shroud .....	2-19 to 2-20
Glass bead .....	2-20
Adapters .....	2-20 to 2-21
Packaging .....	2-21
Assembly instructions .....	2-22

**SMP-LOCK™**

Introduction .....	2-23
Plugs .....	2-24
Receptacles .....	2-24 to 2-25
Adapters and Panel drilling .....	2-25

**SMP-COM**

Introduction .....	2-4
Interface .....	2-12 to 2-13
Characteristics .....	2-26
Plugs .....	2-27
Receptacles .....	2-28
Adapters and Measurement PCB .....	2-28
Packaging .....	2-29
Assembly instructions .....	2-29

## Introduction



	SMP	SMP-COM	SMPM
50Ω	DC - 40 GHz	DC - 12.4 GHz	DC - 65 GHz

**GENERAL**

- Small, lightweight connectors
- Snap-in, suitable for blindmate applications
- Excellent vibration and shock performances
- Allows axial and radial misalignment

**APPLICATIONS**

- Active array antenna
- Satellite
- Airborne / Ship / Ground radar
- Communication equipment
- High speed electro-optical devices
- Board-to-Board applications

**SMP series**

Radiall SMP series meets MIL STD 348, figure 326 interface standard, and DESC specifications 94007 & 94008. They are intermateable with GPO® (Gilbert Engineering Inc.).

There are 3 levels of retention (applicable to the male connectors when ordering) which provide different levels of force required to connect and disconnect the connectors:

- Full detent for a positive locking with a maximum retention
- Limited detent for a positive locking with a medium retention
- Smooth bore for the lowest retention (slide connection)

Radiall also offers multiport solutions with SMP interface allowing better alignment control while mating multiple connectors. The multiport concept increases density and allows the operator to save installation time by connecting several SMP connectors in one operation.

**SMP-COM**

SMP-COM is an economically priced alternative fully intermateable with standard SMP connectors. It has been optimized to operate up to 12.4 GHz meeting the needs of telecom applications. Compared to SMP, which is primarily made of stainless steel material, SMP-COM uses brass material.

**SMPM**

30% smaller than SMP, SMPM connectors are designed for very high frequency applications where space and package density are a necessity.

The Radiall SMPM series meets MIL STD 348, figure 328 interface standard. They are intermateable with GPPPO® (Gilbert Engineering Inc.).

There are 2 levels of retention (applicable to the male connectors when ordering):

- Full detent for a positive locking with a maximum retention
- Smooth bore for a lower retention but higher durability (mating cycles)

Unique visual identification groove: in order to easily identify full detent connectors versus smooth bore, Radiall SMPM full detent receptacles feature a groove on the outer body. This method of identification is an innovation by Radiall.

**SMPM SMT receptacle**

Interface SMPM

**PLUG WITH FEMALE CENTER CONTACT**

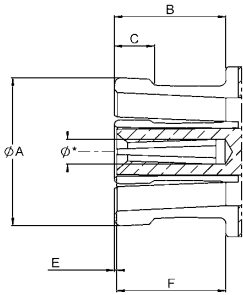

Letter	mm		inch		Note
	min.	max.	min.	max.	
A	-	2.41	-	.095	Dia
B	1.73	-	.068	-	-
C	-	0.58	-	.023	-
E	0	0.20	0	.008	Center contact recession
F	1.27	-	.050	-	-
*	Accept 0.305 +/-0.025 (.012" +/--.001) dia pin				

**JACK WITH MALE CENTER CONTACT (full detent)**

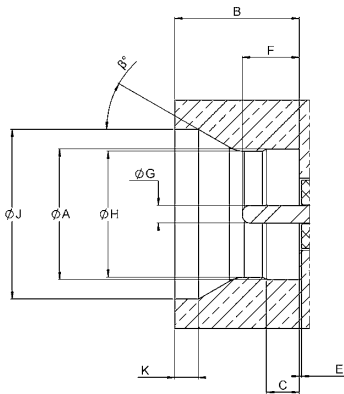

Letter	mm		inch		Note
	min.	max.	min.	max.	
A	2.18	2.24	.086	.088	Dia
B	2.08	2.13	.082	.084	-
C	0.53	0.58	.021	.023	-
E	0	0.12	0	.004	-
F	0.76	1.14	.030	.045	-
G	0.28	0.33	.011	.013	Dia
H	2.11	2.16	.083	.085	Dia
J	2.82	2.92	.111	.115	Dia
K	0.25	0.56	.010	.022	-
b	25	35	-	-	Degree

**JACK WITH MALE CENTER CONTACT (smooth bore)**

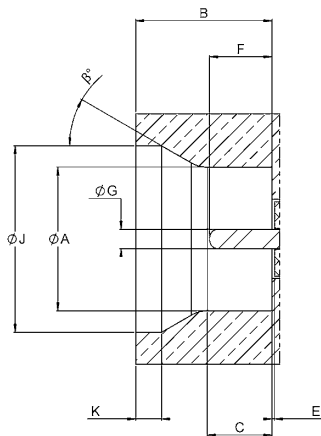

Letter	mm		inch		Note
	min.	max.	min.	max.	
A	2.18	2.24	.086	.088	Dia
B	2.08	2.13	.082	.084	-
E	0	0.12	0	.004	-
F	0.76	1.14	.030	.045	-
G	0.28	0.33	.011	.013	Dia
J	2.82	2.92	.111	.115	Dia
K	0.25	0.56	.010	.022	-
b	25	35	-	-	Degree



## Characteristics

Test / Characteristics	Values / Remarks
<b>ELECTRICAL CHARACTERISTICS</b>	
Impedance	50Ω
Frequency range	DC - 65 GHz
V.S.W.R. • Straight styles • Right angle styles • Adapters • Hermetic receptacles	1.10 to 12GHz / 1.15 to 26GHz / 1.30 to 40GHz 1.25 to 12GHz / 1.30 to 18GHz 1.10 to 12GHz / 1.20 to 40GHz / 1.30 to 65GHz 1.15 to 18GHz / 1.35 to 40GHz
Insertion loss (dB)	0.10 × √F Max typ
Insulation resistance (MΩ)	5000
Voltage rating (V.R.M.S.)	335
Dielectric withstanding voltage (V.R.M.S.)	500
RF leakage (dB)	-80 to 3GHz / -65 from 3 to 40GHz

## MECHANICAL CHARACTERISTICS

	Smooth bore	Full detent
Mechanical endurance (durability)	500	100
Engagement force (N)	18 max - 11 typ.	36 max - 20 typ.
Separation force (N)	7 min - 9 typ.	20 min - 30 typ.
Radial misalignment Axial misalignment	± 0.25 mm (.010") 0 / + 0.25 mm (.010")	
Vibration	MIL-STD 202G Method 104, test condition D	
Shock	MIL-STD 202G Method 213, test condition I	
Thermal shock	-65° C / +125° C	
Cable retention (N) • .47" • .85"	> 45 N > 200 N	
Contact captivation axial (N)	6.7	

## ENVIRONMENTAL CHARACTERISTICS

Operating temperature	-65°C / +165°C
-----------------------	----------------

## MATERIALS

Cable connector with female center contact	Beryllium copper
Cable connector with male center contact • Bodies • Soldering part	Stainless steel, Beryllium copper Brass
Receptacles, shrouds	stainless steel & Beryllium copper
In series adapters	Beryllium copper
Center contacts	Beryllium copper
Center contacts for glass seal	Iron nickel cobalt sealing alloy
Insulators	Peek / PTFE

## PLATING

Cable connector with female center contact	Gold
Cable connector with male center contact • Bodies • Soldering part	Passivated Gold
Receptacles, shrouds	Passivated
Center contacts	Gold

Plugs and Jacks

**STRAIGHT PLUGS, SOLDER TYPE FOR SEMI-RIGID CABLES**

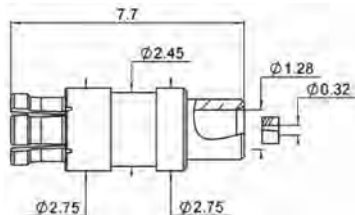
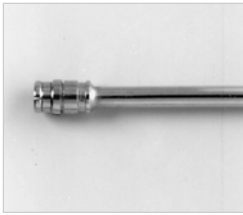

Fig. 1

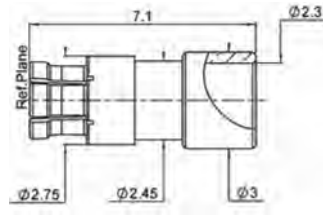

Fig. 2

Cable group	Cable group dia.	Part number	Fig.	Captive center contact	Finish
.047" semi-rigid	.047"	R201 051 000	1	Yes	Gold
RG405	.085"	R201 052 000	2		

**RIGHT ANGLE PLUGS, FOR SEMI-RIGID AND FLEXIBLE CABLES**

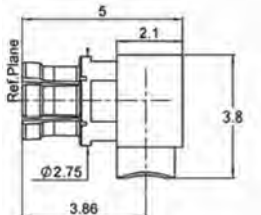

Fig. 1

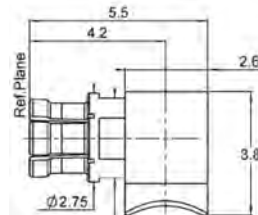

Fig. 2

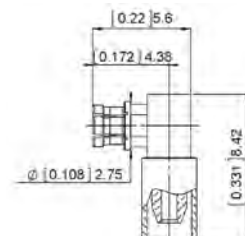

Fig. 3

Cable group	Cable group dia.	Part number	Fig.	Captive center contact	Finish
.047" semi-rigid	.047"	R201 151 000	1	Yes	Gold
RG405	.085"	R201 152 000	2		
RG178 / RG196	2/50S	R201 170 110	3		

**JACK, SOLDER TYPE FOR SEMI-RIGID CABLES**

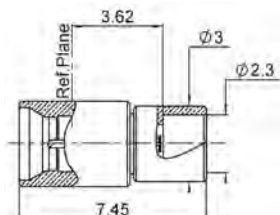
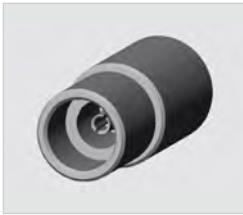

Fig. 1

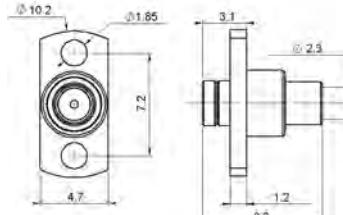

Fig. 2

Cable group	Cable group dia.	Part number	Fig.	Captive center contact	Retention	Finish
RG405	.085"	R201 223 100	2	Yes	Full detent	Gold
		R201 223 700	1		Smooth bore	
		R201 223 710	2			

Receptacles

PCB STRAIGHT RECEPTACLES (with male center contact)

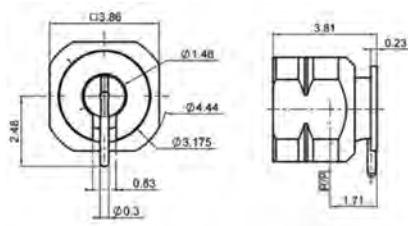

Fig. 1

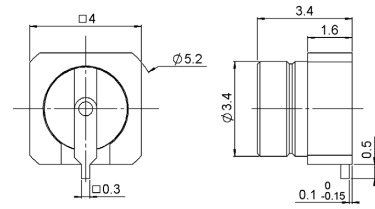

Fig. 2

Part number	Fig.	Retention	Assembly instructions	Finish	Note	Packaging
R201 508 000	1	Full detent	M01	Gold	Surface mount	100
R201 508 040	2			NPGR	Low profile	Tape & Reel 500 pieces
R201 508 700	1	Smooth bore		Gold	Surface mount	100

PCB RECEPTACLE, EDGE CARD MOUNT (with male center contact)

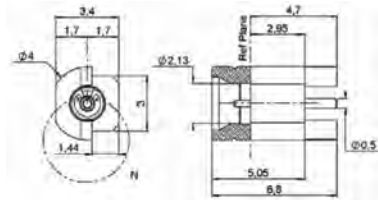
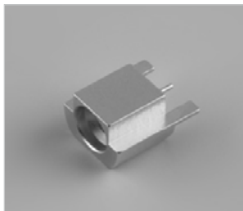

Fig. 1

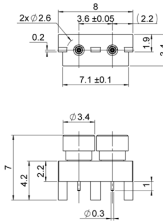

Fig. 2

Part number	Fig.	Retention	Assembly instructions	Finish	Packaging	Note
R201 423 110	1	Full detent	M02	Gold	100	-
R201 423 200	2		M03	NPGR	Tape & Reel 500 pieces	Dual part
R201 423 700		Smooth bore				

PANEL STRAIGHT HERMETIC RECEPTACLE, SOLDER MOUNT (with male center contact)

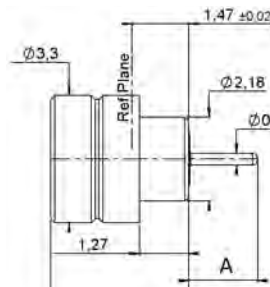

Fig. 1

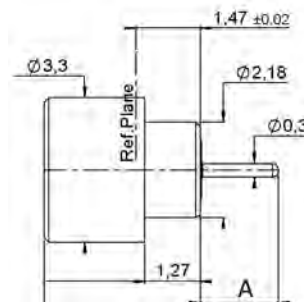

Fig. 2

Part number	Fig.	Dimension A (mm)	Retention	Panel drilling	Finish
R201 645 000	1	1.78	Full detent	P02	Gold
R201 645 020		2.28			
R201 645 700	2	1.78	Smooth bore		
R201 645 710		2.28			
R201 645 720		0.76			

Receptacles, Panel Shroud and Adapters

**THREAD-IN RECEPTACLES (with male center contact)**

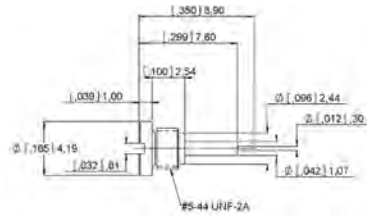
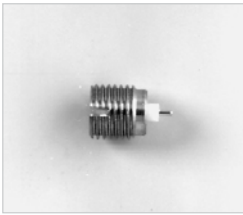

Fig. 1

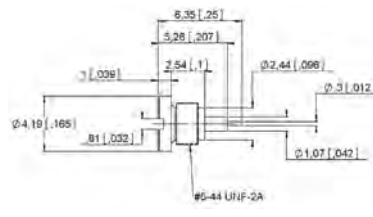
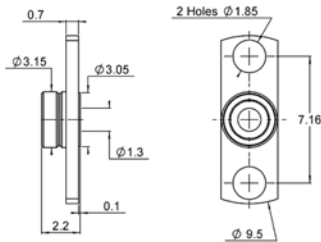
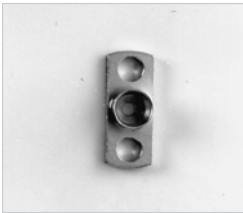

Fig. 2

Part number	Fig.	Retention	Panel drilling	Finish
R201 561 021	1	Full detent	P03	Passivated
R201 561 721	2	Smooth bore		

**PANEL SHROUD, 2 HOLES FLANGE MOUNT (no center contact)**



Part number	Retention	Panel drilling	Finish
R201 450 001	Full detent	P01	Passivated
R201 450 701	Smooth bore		

**Note:**

We recommend using Radiall glass bead R280 760 050. Glass beads can be found in Chapter 17 - Tooling & Accessories.

**IN SERIES ADAPTERS (female to female center contact)**

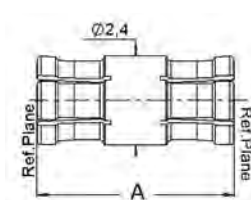

Fig. 1

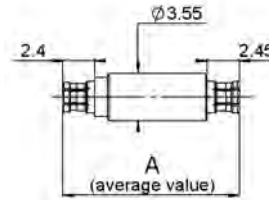

Fig. 2

Part number	Fig.	Dimension A mm (inch)	Type	Finish
R201 705 000	1	5.33 (.210)	Fixed length	Gold
R201 705 110		8.5 (.330)		NPGR
R201 705 120		5.33 (.210)		
R201 723 1_0	2	Consult us	Spring loaded	Gold

Adapters

BETWEEN SERIES ADAPTERS, DC-40 GHz

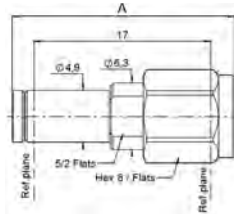

Fig. 1

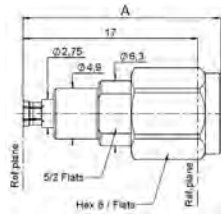

Fig. 2

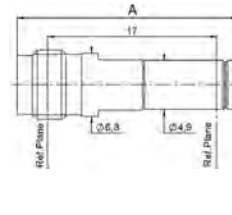

Fig. 3

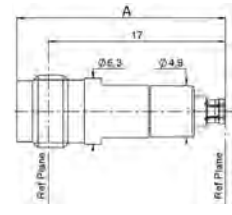

Fig. 4

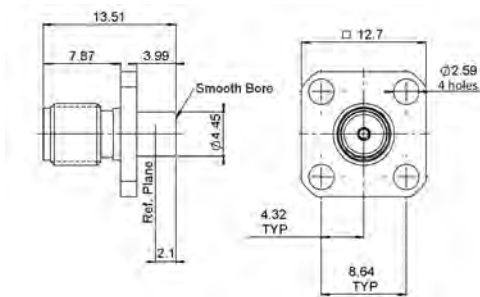

Fig. 5

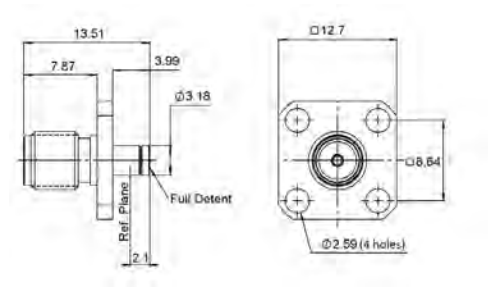

Fig. 6

Part number	Fig.	Dimension A	Description	Finish	Packaging
R191 562 000	1	21.4	SMPM male full detent / 2.4 mm male	Gold	Unit
R191 563 000	2	19.27	SMPM female / 2.4 mm male		
R191 564 000	3	22.15	SMPM male full detent / 2.4 mm female		
R191 565 000	4	20.05	SMPM female / 2.4 mm female		
5964-9513-001	5	-	SMPM male smooth bore / SMA female	Passivated	
5965-9513-000	6	-	SMPM male full detent / SMA female		
R191 956 020	1	17	SMPM male smooth bore / SMA2.9 male	Gold	
R191 957 000	2	17	SMPM female / SMA2.9 male		
R191 958 000	3	18	SMPM male full detent / SMA2.9 female		
R191 958 020	3	18	SMPM male smooth bore / SMA2.9 female		
R191 959 000	4	18	SMPM female / SMA2.9 female		

All 2.4 mm adapters feature identical electrical lengths.

Panel Drilling

PANEL CUT OUT

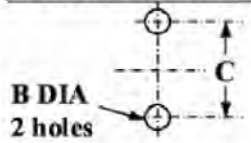

P01	
B	1.8 - 1.9 (.071 - .075)
C	7.11 - 7.21 (.0280 - .284)

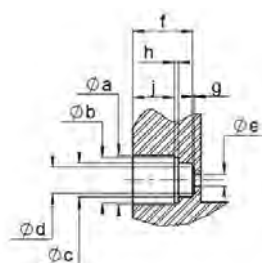

P02	
A	3.36 - 3.38
B	3.03 - 3.15
C	2.27 - 2.29
D	1.63 - 1.73
E	0.79 - 0.83
F	4.52 - 4.56
G	0.13 - 0.17
H	0.28 - 0.38
J	3.15 - 3.19



Panel Drilling

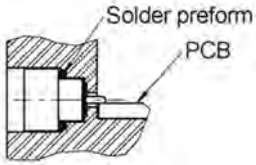

1. Degrease and clean connector and box.
2. Solder the connector on the panel. We advise using SnAg4 Cu0.5 and a low residue flux. Preheating at 100°C is recommended. Take care not to exceed 260°C during soldering operation.
3. Solder the pin on the track. We advise using SnAg4 Cu0.5 and a low residue flux. Preheating at 100°C is recommended for ceramic substrate. Take care not to exceed 260°C during soldering operation.

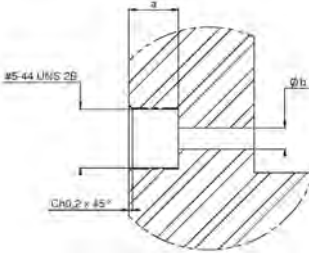

P03	
A	5.31 - 5.33
B	1.09 - 1.12

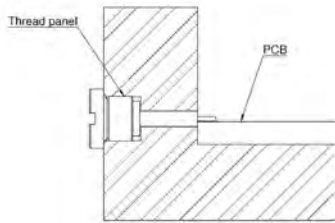

1. Degrease and clean connector and box
2. Screw-on the connector on the panel
3. Solder the pin on the track

Assembly Instructions

M01

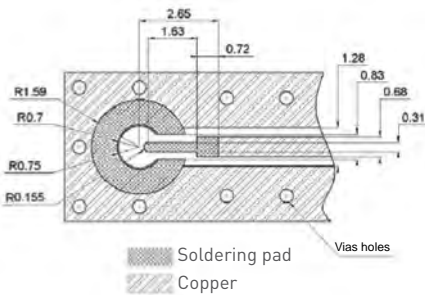

Connectors	
R201 508 000	
R201 508 700	

Valid for RT DUROID 5880 type PCB, thickness 0.254mm, with copper layer 35µm on both sides. Add between both sides along upper ground plane according to engineering practices.

M02

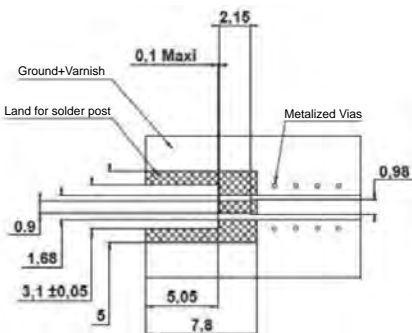

Connectors	
R201 423 110	

M03

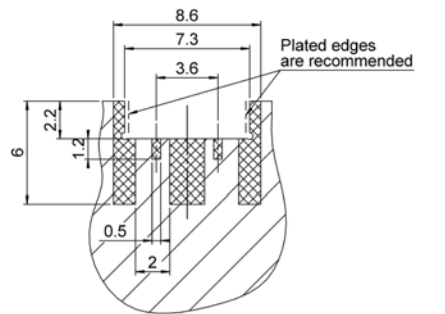

	Pattern
	Land for solder paste

Interface SMP

**JACK WITH MALE CENTER CONTACT (full detent or limited detent)**

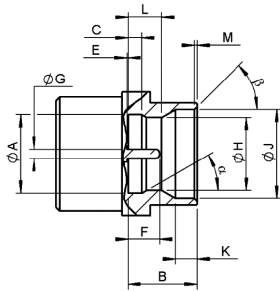

Letter	mm		inch		Note
	min.	max.	min.	max.	
A	3.15	3.20	.124	.126	Dia
B	2.74	2.84	.108	.112	-
C	0.52	0.60	.0205	.0235	-
E	0.00	-	0	-	Center contact recession
F	1.14	1.40	.045	.055	-
G	0.36	0.41	.014	.016	Dia
H	2.90	3.00	.114	.118	Dia: Full detent
	3.00	3.10	.118	.122	Dia: Limited detent
J	3.53	3.68	.139	.145	Dia
K	0.84	0.94	.033	.037	-
L	1.30	1.45	.051	.057	Full detent
	1.37	1.52	.054	.060	Limited detent
M	0.08	0.20	.003	.008	-
a	30				Degree (nom.)
b	40	50	40	50	Degree

**JACK WITH MALE CENTER CONTACT (smooth bore)**

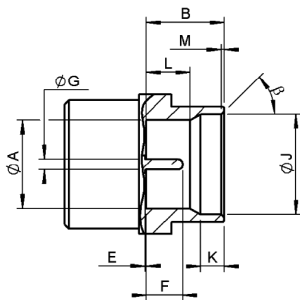

Letter	mm		inch		Note
	min.	max.	min.	max.	
A	3.12	3.23	.123	.127	Dia
B	2.74	2.84	.108	.112	-
E	0.00	-	0	-	Center contact recession
F	1.14	1.40	.045	.055	-
G	0.36	0.41	.014	.016	-
J	3.53	3.68	.139	.145	Dia
K	0.84	0.94	.033	.037	-
L	1.50	1.65	.059	.065	-
M	0.08	0.20	.003	.008	-
b	40	50	40	50	Degree

**PLUG WITH FEMALE CENTER CONTACT AND EMI SHIELD (cabled connection)**

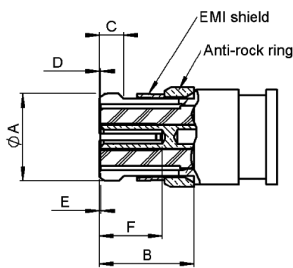

\* Accept .015 ±.001 dia pin

Letter	mm		inch		Note
	min.	max.	min.	max.	
A	-	3.43	-	.135	Dia
B	2.84	-	.112	-	-
C	0.46	0.64	.018	.025	-
D	-	0.00	-	0	Dielectric projection
E	0.00	0.20	0	.008	Center contact recession
F	1.78	-	0.70	-	-

**PLUG WITH FEMALE CENTER CONTACT (cabled connection)**

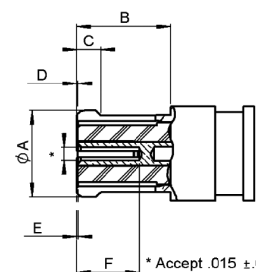

\* Accept .015 ±.001 dia pin

Letter	mm		inch		Note
	min.	max.	min.	max.	
A	-	3.43	-	.135	Dia
B	2.84	-	.112	-	-
C	0.46	0.64	.018	.025	-
D	-	0.00	-	0	Dielectric projection
E	0.00	0.20	0	.008	Center contact recession
F	1.78	-	0.70	-	-

Interface SMP

JACK WITH MALE CENTER CONTACT (catcher's mitt)

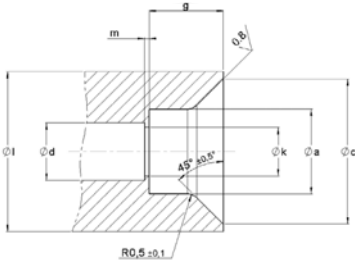

Letter	mm		inch		Note
	min.	max.	min.	max.	
A	3.12	3.23	.123	.127	Dia
C	5.40	5.50	.213	.217	Dia
D	0.37	0.39	.0146	.0154	Dia
F	1.10	1.18	.043	.046	-
G	2.77	2.81	.109	.111	-
K	0.00	-	0	-	Center contact recess
L	0.00	-	0	-	Insulator recess
M	1.15	1.39	.045	.055	-

**Note:**  
Catcher's Mitt interface is not defined in MIL-STD-348 standard.

Interface SMP-COM

MALE CONNECTOR (full detent or limited detent)

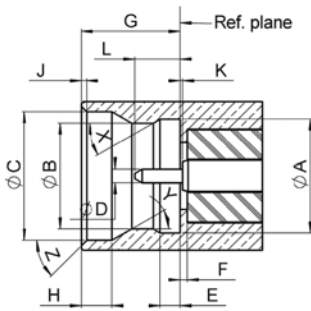

Dia A	3.18+/-0.02
Dia B (Full detent)	2.95+/-0.02
Dia B (Limited detent)	3.05+/-0.02
Dia C	3.59 +/-0.02
Dia D	0.38+/-0.02
E	0.56+/-0.03
F	0.2+/-0.025
G (Full detent)	2.79+/-0.02
G (Limited detent)	2.77+/-0.02
H	0.86+/-0.02
J	0.15+/-0.05
K	0.07+/-0.07
L	1.27+/-0.12
X	30°+/-0.5°
Y	30°+/-0.5°
Z	45° nom

MALE CONNECTOR (smooth bore)

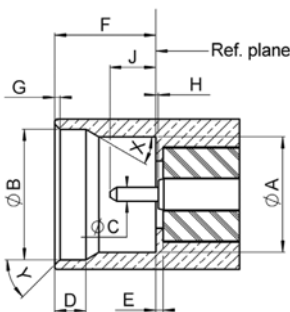

Dia A	3.18+/-0.02
Dia B	3.59+/-0.02
Dia C	0.38+/-0.02
D	0.86+/-0.02
E	0.2+/-0.025
F	2.79+/-0.02
G	0.15+/-0.05
H	0.07+/-0.07
J	1.27+/-0.12
X	30°+/-0.5°
Y	45° nom

FEMALE CONNECTOR

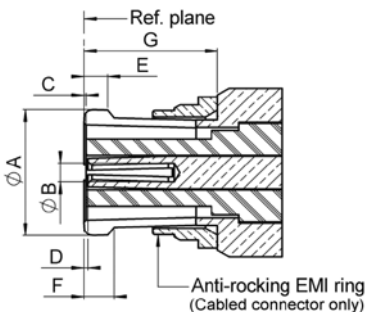

Dia A	3.275+/-0.025
Dia B	0.49+/-0.02
C	0.05+/-0.05
D	0.05+/-0.05
E	0.59+/-0.02
F	0.76+/-0.1
G	3.4+/-0.03

## Characteristics

Test / Characteristics	Values / Remarks
------------------------	------------------

**ELECTRICAL CHARACTERISTICS**

Impedance	50Ω		
Frequency range	DC - 40 GHz		
Typical V.S.W.R.	DC-12 GHz	12-26.5 GHz	26.5-40 GHz
• Straight styles	1.15	1.15	1.5
• Right angle styles	1.25	1.35	-
• Adapters	1.10	1.15	1.5
• Receptacles	1.30	-	-
Insertion loss (dB)	0.12 vF (F in GHz)		
Insulation resistance (MΩ)	5000		
Voltage rating (V.R.M.S.)	335		
Dielectric withstanding voltage (V.R.M.S.)	500		
RF leakage	-80 dB to 3 GHz / -65 dB from 3 to 26.5 GHz - 100 dB DC to 18 GHz		
• Standard plugs			
• Plug with EMI gasket			

**MECHANICAL CHARACTERISTICS**

	Smooth bore	Limited detent	Full detent
Mechanical endurance (matings)	1000	500	100
Engagement and separation force (N)	9 max. - 2.2 min.	45 max. - 9 min.	68 max. - 22 min.
Radial misalignment Axial misalignment	± 0.25 mm (± .010") 0, + 0.25 mm (0/ .010")		
Vibration	MIL-STD-202 method 204, test condition D		
Shock	MIL-STD-202 method 213, test condition I		
Thermal shock	MIL-STD-202 method 107, test condition B		
Cable retention (N)			
• .047"	45		
• .085"	200		
Contact captivation axial (N)	6.8		

**ENVIRONMENTAL CHARACTERISTICS**

Operating temperature	-65°C / +165°C
-----------------------	----------------

**MATERIALS**

Cable connector with female center contact	Beryllium copper
Cable connector with male center contact	
• Bodies	Stainless steel
• Soldering part	Brass
Receptacles, shrouds	Stainless steel
In series adapters	Beryllium copper
Center contacts	Beryllium copper
Center contacts for glass seal	Iron nickel cobalt sealing alloy
Insulators	PTFE

**PLATING**

Cable connector with female center contact	Gold
Cable connector with male center contact	
• Bodies	Passivated
• Soldering part	Gold
Receptacles, shrouds	Passivated
In series adapters	Gold
Center contacts	Gold

Plugs and Jacks

SMP

**PLUG, SOLDER TYPE FOR SEMI-RIGID CABLES (with female center contact)**

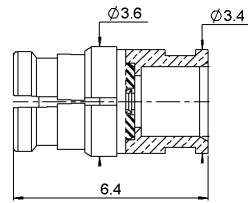
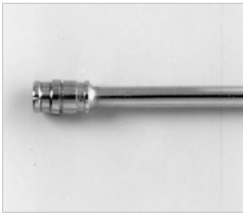

Fig. 1

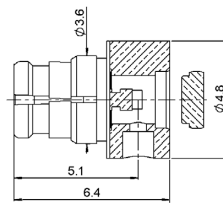

Fig. 2

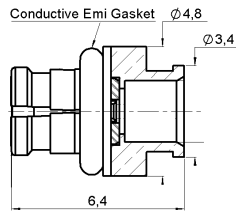
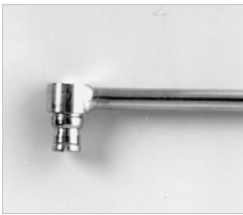

Fig. 3

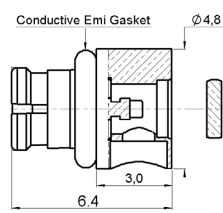

Fig. 4

Cable group	Cable group dia.	Part number	Fig.	Captive center contact	Orientation	Finish	Note
.047" semi-rigid	.047"	R222 051 000	1	No	Straight	Gold	-
RG405	.085"	R222 052 000					
.085" micro-porous	.085"	R222 052 300					
.047" semi-rigid	.047"	R222 151 000	2	Yes	Right angle		
RG405	.085"	R222 152 000					
		R222 062 100	3	No	Straight		
		R222 162 100				4	Yes

**STRAIGHT JACK, SOLDER TYPE FOR SEMI RIGID CABLES (with male center contact)**

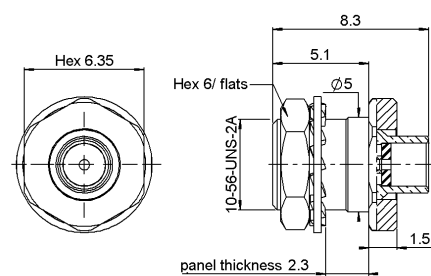

Fig. 1

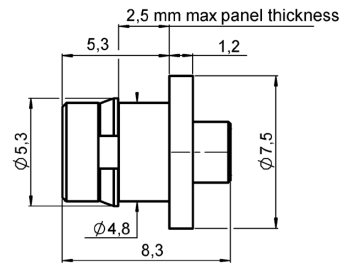

Fig. 2

Cable group	Cable group dia.	Part number	Retention	Fig.	Note	Captive center contact	Panel drilling	Finish
RG405	.085"	R222 302 002	Full detent	1	Bulkhead feedthrough	No	P05	Passivated + Gold (soldering part)
		R222 302 302	Limited detent					
		R222 302 702	Smooth bore					
		R222 223 002	Full detent	2	Snap-in		P08	
		R222 223 302	Limited detent					
		R222 223 702	Smooth bore					



Jacks and Receptacles

**TWO HOLE FLANGE JACK SOLDER TYPE FOR SEMI RIGID CABLES  
(with male center contact)**

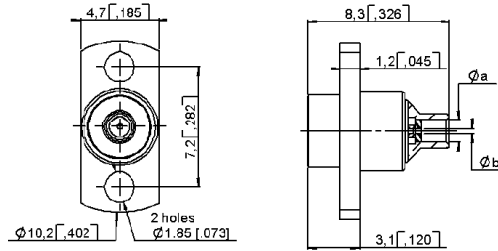

Cable group	Cable group dia.	Part number	Retention	Dimensions mm (inch)		Captive center contact	Panel drilling	Finish
				$\varnothing A$	$\varnothing B$			
RG405	.085"	R222 252 001	Full detent	2.30 (.091)	0.60 (.024)	No	P01	Passivated + Gold (soldering part)
		R222 252 301	Limited detent					
		R222 252 702	Smooth bore					

**PCB STRAIGHT RECEPTACLE, 4 SOLDER LEGS (with male center contact)**

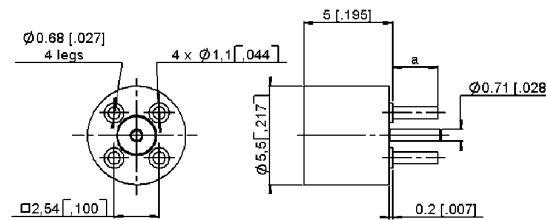

Part number	Retention	Dimensions mm (inch)	PCB mounting	Finish
		A		
R222 426 000	Full detent	2.5 (.098)	P03	Gold
R222 426 300	Limited detent			
R222 426 700	Smooth bore			
R222 426 020	Full detent	3.6 (.142)		
R222 426 320	Limited detent			
R222 426 720	Smooth bore			

**MICROSTRIP RECEPTACLE, EDGE CARD MOUNT**

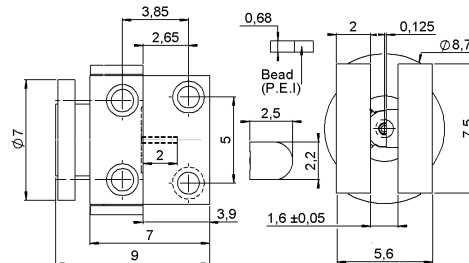

Part number	Retention	Finish	Assembly instructions	Note
R222 423 041	Full detent	Passivated	See technical data sheet	Supplied with dielectric bead

Receptacles

PCB STRAIGHT RECEPTACLE, SURFACE MOUNT (with male center contact)

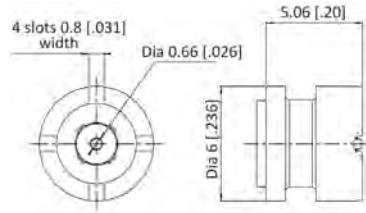

Fig. 1

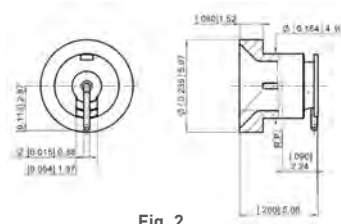

Fig. 2

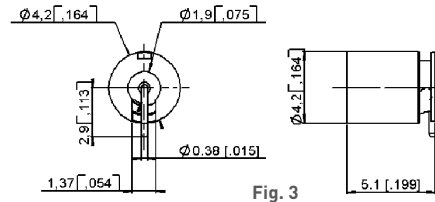

Fig. 3

Part number	Fig.	Retention	Assembly instructions	Finish	Packaging
R222 408 350	1	Limited detent	M04	Gold	Tape & Reel 500 pieces
R222 408 750		Smooth bore			Tray 100 pieces
R222 508 000	3	Full detent	M03	Passivated + Gold (soldering area)	Tape & Reel 500 pieces
R222 508 300		Limited detent			
R222 508 700		Smooth bore			
R222 508 722	2	Catcher's mitt			

PCB RECEPTACLE, EDGE CARD MOUNT (with male center contact)

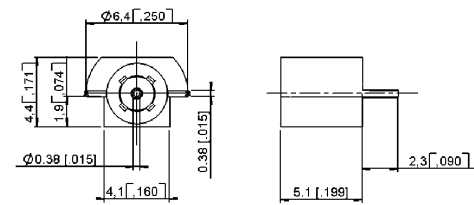
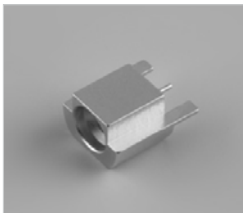

Fig. 1

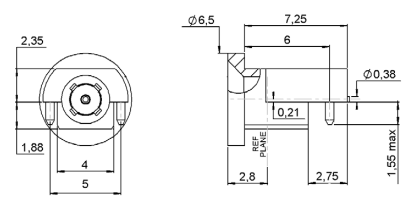
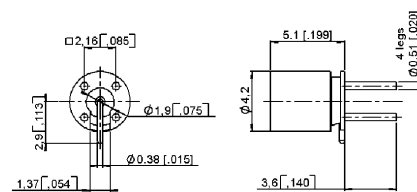

Fig. 2

Part number	Retention	Fig.	Assembly instructions	Finish	Packaging
R222 423 023	Full detent	1	M01	Gold	Tape & Reel 500 pieces
R222 423 320	Limited detent				
R222 423 720	Smooth bore				
R222 680 710	Catcher's mitt	2	M05		

PCB STRAIGHT RECEPTACLE, PIN & PASTE MOUNT (with male center contact)



Part number	Fig.	Retention	Assembly instructions	Finish
R222 428 000	1	Full detent	M02	Passivated + Gold (soldering part)
R222 428 300		Limited detent		
R222 428 700		Smooth bore		

Receptacles

PCB RIGHT ANGLE RECEPTACLE, 4 SOLDER LEGS (with male center contact)

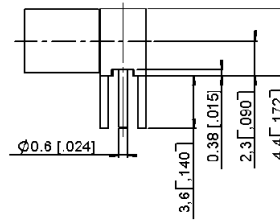
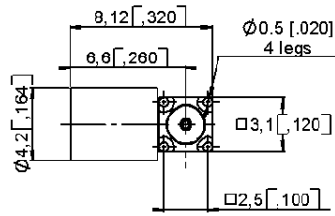

Part number	Retention	PCB mounting	Finish
R222 680 000	Full detent	P04	Passivated + Gold (soldering part)
R222 680 300	Limited detent		
R222 680 700	Smooth bore		

SQUARE FLANGE RECEPTACLES

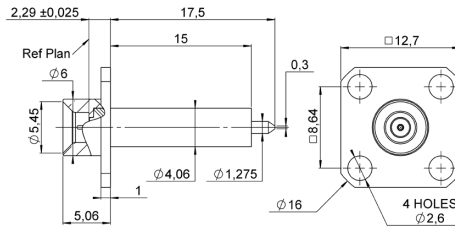

Fig. 1

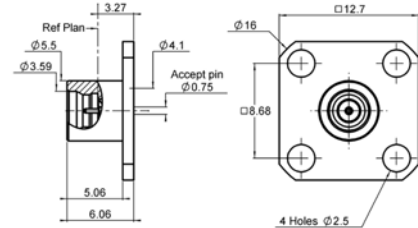
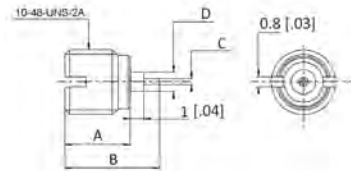
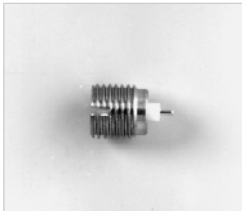

Fig. 2

Part number	Retention	Fig.	Captive center contact	Panel drilling	Finish
R222 414 711	Limited detent	1	Yes	P07	Passivated
R222 411 001	Full detent	2			

THREAD-IN RECEPTACLE (with male center contact)



Part number	Retention	Dimensions mm (inch)				Finish
		A	B	C	D	
R222 561 001	Full detent	4.8 (.191)	7.1 (.278)	0.46 (.018)	1.45 (.057)	Passivated
R222 561 301	Limited detent					
R222 561 701	Smooth bore					
R222 561 331	Limited detent	6.2 (.243)	8.3 (.326) +/-0.5 with sliding pin R280 473 1X0	1.0 (.04)		

Receptacles and Panel Shroud

**PANEL STRAIGHT HERMETIC RECEPTACLE, SOLDER MOUNT (with male center contact)**

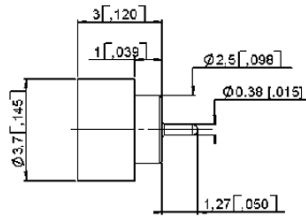
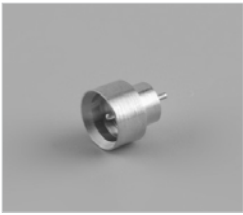

Fig. 1

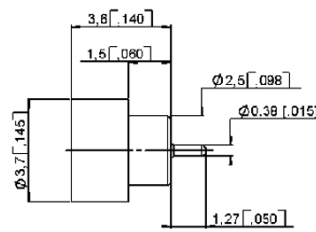
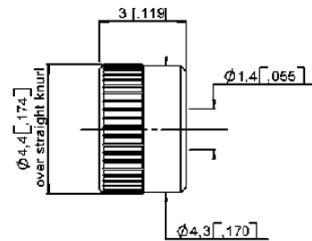
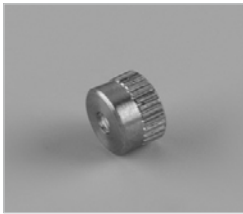

Fig. 2

Part number	Retention	Fig.	Finish	Note
R222 645 020	Full detent	1	Gold	Short body 1mm glass seal
R222 645 320	Limited detent			-
R222 645 000	Full detent	2		-
R222 645 300	Limited detent			-
R222 645 700	Smooth bore			1.5mm glass seal

Other dimensions available, please consult us.

**PANEL SHROUD, PRESS-IN MOUNT (no center contact)**



Part number	Retention	Panel drilling	Finish
R222 402 021	Full detent	P06	Passivated
R222 402 321	Limited detent		
R222 402 721	Smooth bore		

This shroud is designed to be used with hermetic glass seal R280 752 000 (see next page).

**PANEL SHROUD, 2 HOLES FLANGE MOUNT (no center contact)**

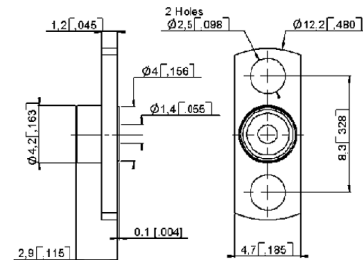

Part number	Retention	Panel drilling	Finish
R222 450 001	Full detent	P02	Passivated

This shroud is designed to be used with hermetic glass bead R280 752 000 - more glass beads can be found in Chapter 17 - Tooling & Accessories.

Panel Shroud, Glass Bead and Adapters

**PANEL SHROUD, THREAD-IN MOUNT (no center contact)**

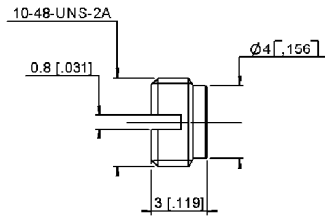

Part number	Retention	Finish
R222 550 001	Full detent	Passivated
R222 550 301	Limited detent	
R222 550 701	Smooth bore	

This shroud is designed to be used with hermetic glass seal R280 752 000

**HERMETIC GLASS BEAD**

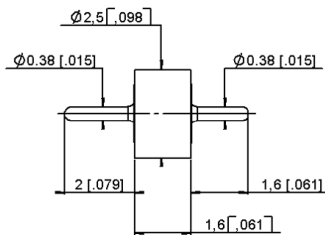

Part number
R280 752 000

More glass beads can be found in Chapter 17 - Tooling & Accessories.

**IN SERIES ADAPTERS (female to female center contact)**

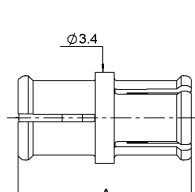

Fig. 1

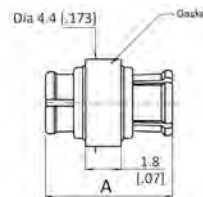

Fig. 2

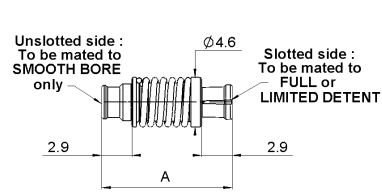

Fig. 3

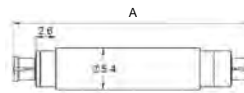

Fig. 4

Part number	Fig.	Dimensions A mm (inch)	Type	Finish
R222 705 000	1	6.45 (.254)	Fixed length	Gold
R222 705 200		5.7 (.224)		
R222 705 220		10.3 (.405)		
R222 705 239		10.0 (.395)		
R222 705 320		36.3 (1.43)		
R222 705 380		26.9 (1.06)		
R222 705 340		24.6 (.969)		
R222 705 210		14.2 (.559)		
R222 705 370		13.2 (.520)		
R222 705 250		12.6 (.496)		
R222 705 360		7.2 (.283)		
R222 705 400		2		
R222 723 110	3	min 11.71 (.461) max 12.88 (.507)	Spring loaded axial travel 1.17mm (.046")	
R222 723 120		min 17.65 (.695) max 18.82 (.741)		
R222 723 140	4	min 31.3 (1.23) max 37.3 (1.47)	Spring loaded axial travel 6.0mm (.236")	

**Note:**  
Use removal tool R282 918 120 with SMP in series adapters.

Contact us for self aligning options in board to board or module to module applications.



Adapters

BETWEEN SERIES ADAPTERS

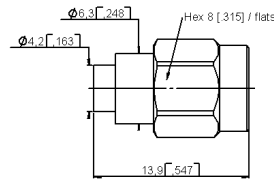

Fig. 1

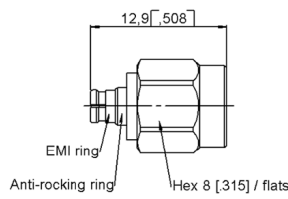

Fig. 2

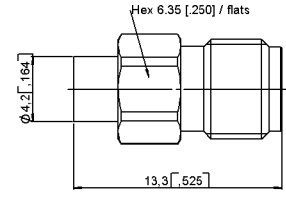

Fig. 3

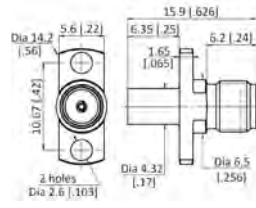

Fig. 4

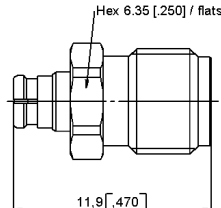

Fig. 5

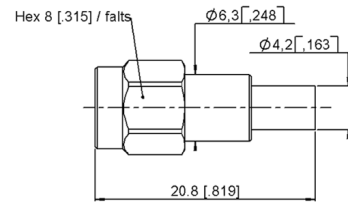

Fig. 6

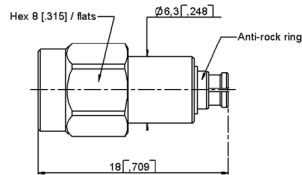

Fig. 7

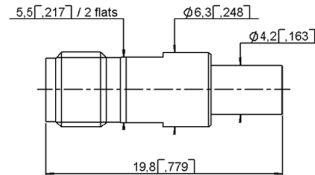

Fig. 8

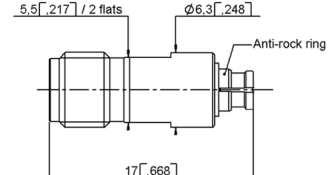
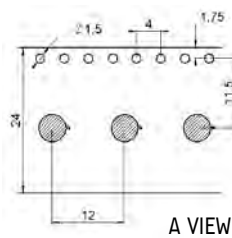
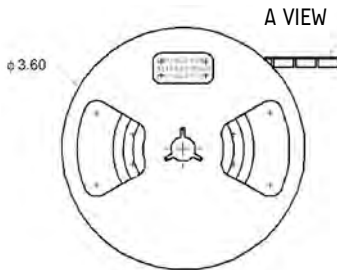

Fig. 9

Part number	Fig.	Description	Captive center contact	Finish	Packaging
R191 841 001	1	SMA male / SMP male full detent	Yes	Passivated	100
R191 842 002	2	SMA male / SMP female		Passivated / Gold	
R191 843 001	3	SMA female / SMP male full detent		Passivated	
R191 843 409	4	SMA female / SMP male smooth bore		Passivated / Gold	
R191 843 429		SMA female / SMP male full detent			
R191 844 002	5	SMA female / SMP female		Passivated	100
R191 966 001	6	SMA2.9 male / SMP male full detent		Passivated / Gold	
R191 967 002	7	SMA2.9 male / SMP female		Passivated	
R191 968 001	8	SMA2.9 female / SMP male full detent		Passivated / Gold	100
R191 969 002	9	SMA2.9 female / SMP female	Passivated		
				Passivated / Gold	

Packaging



Connectors	Packaging
R222 508 000	Tape & Reel 500 pieces
R222 508 300	
R222 508 700	
R222 508 722	
R222 680 710	

Assembly Instructions

M01

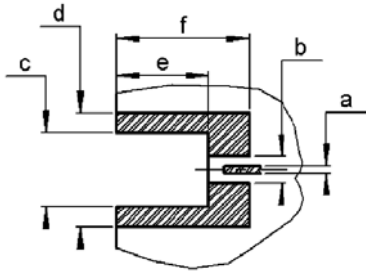

Connectors	
R222 423 023 R222 423 320	R222 423 720

PCB mounting pattern

A	0.48
B	1.5
C	4.18 - 4.32
D	6.5
E	4.95 - 5.45
F	7.52

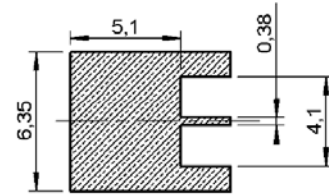

Shadow of receptacle for video camera

M02

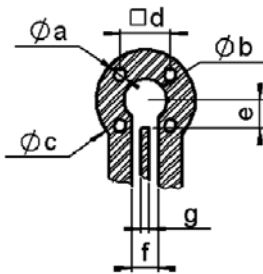

Connectors	
R222 428 000 R222 428 300	R222 428 700

PCB mounting pattern

A	0.63
B	1.90
C	4.45 min.
D	2.16
E	2.29 max.
F	1.52 max.
G	0.45 min.

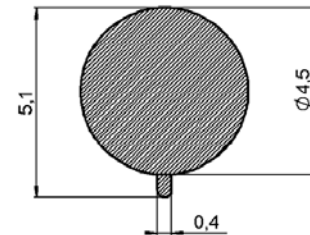

Shadow of receptacle for video camera

M03

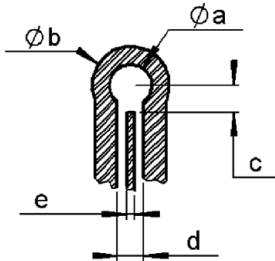

Connectors	
R222 508 000 R222 508 300	R222 508 700 R222 508 722

PCB mounting pattern

A	1.91
B	4.45 min.
C	2.29 min.
D	1.52
E	0.38 max.

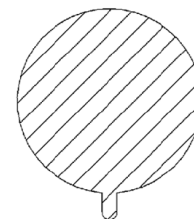

Shadow of receptacle for video camera

M04

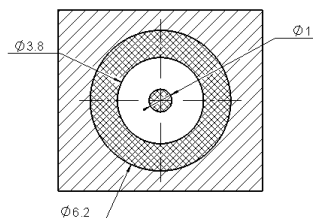

Connectors	
R222 408 350	R222 408 750

PCB mounting pattern

M05

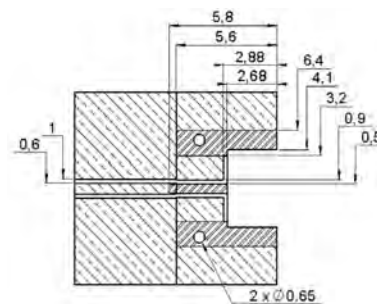

Connectors	
R222 680 710	

Shadow of receptacle for video camera

## Introduction

### SMP-LOCK™: The Ultimate Secure Connection

Radiall has expanded its broad range of SMP products with SMP-LOCK™ connectors featuring a robust locking mechanism, which dramatically increases the retention force of the interface and prevents accidental disconnection.

They have been specially designed for harsh environments and to withstand more severe vibration and drop tests.

SMP-LOCK™ connectors are suitable for cable-to-cable or cable-to-module interconnections inside equipment subject to harsh mechanical stress such as airborne radars, avionics, satellites, missile, UAV and UGV applications.

#### Features & benefits

- Excellent electrical performance combined with robust locking feature
- Two step connection, low insertion force
- Audible click indicates that plug is locked, eliminating accidental disconnections
- Locking sleeve provides greater retention force more than 450 N with RG-405 cable
- SMP interface has a high frequency DC-40 GHz
- Plug equipped with EMI ring offers improved RF leakage performance -92dB at 18 GHz
- SMP-LOCK™ uses limited detent interface for lower connect/disconnect forces, less mechanical stress and a longer life cycle
- Extraction tool available for easy unmating in high density panels
- IP67 rating when mated

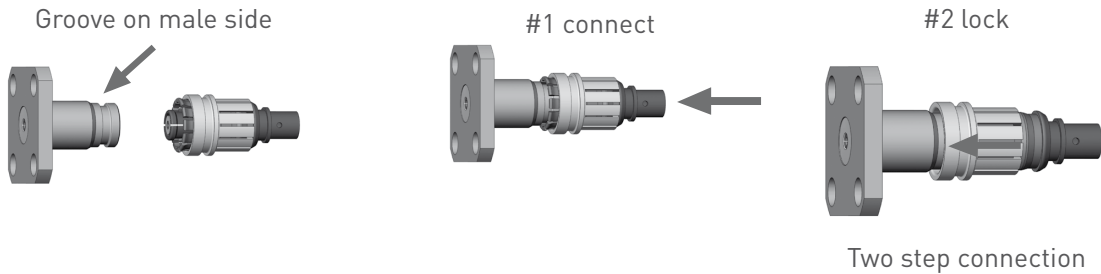

Plugs and Receptacles

FEMALE PLUGS, SOLDER TYPE FOR SEMI-RIGID CABLE

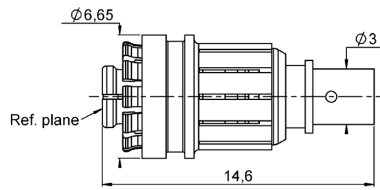

Fig. 1

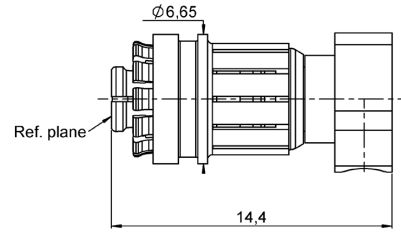
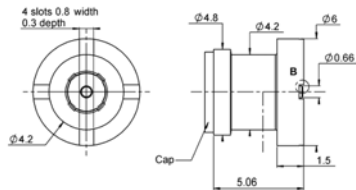
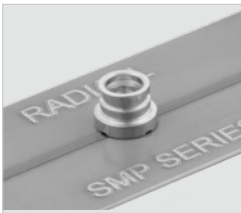

Fig. 2

Cable group	Cable group dia.	Part number	Fig.	Finish	Captive center contact	Geometry
RG405	.085"	R222 L80 010	1	Nickel + Gold	No	Straight
		R222 L80 300	2		Yes	Right angle

STRAIGHT MALE SMT RECEPTACLE



Part number	Body & finish	Captive center contact
R222 L00 010	Brass, N2PGR	Yes

STRAIGHT AND RIGHT ANGLE MALE PCB RECEPTACLE

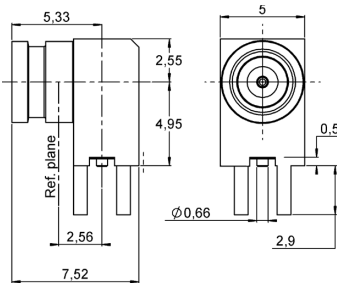

Fig. 1

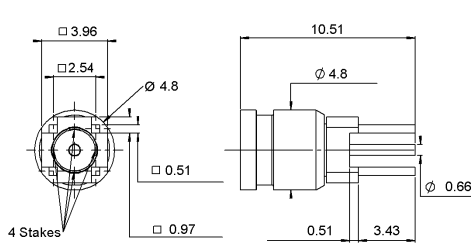

Fig. 2

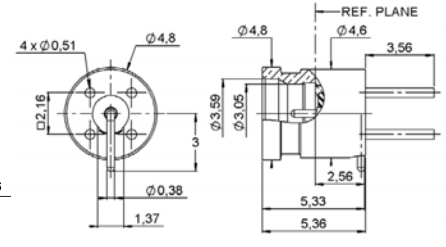
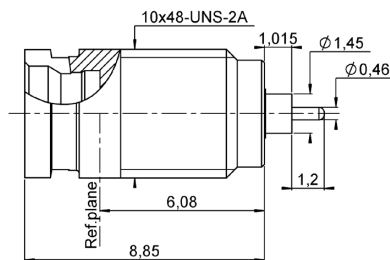

Fig. 3

Part number	Fig.	Panel drilling	Body & finish	Captive center contact
R222 L00 000	1	P01	Brass, N2PGR	Yes
R222 L00 020	2	P06	Brass, Gold	
R222 L00 040	3	-		

SCREW-ON MALE RECEPTACLE



Part number	Panel drilling	Body & finish	Captive center contact	Contact type
R222 L10 001	P02	Stainless steel passivated	Yes	Cylindrical

Receptacles and Adapters

HERMETIC SCREW-ON MALE RECEPTACLE

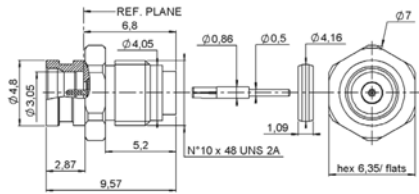

Part number	Panel drilling	Body & finish	Captive center contact	Contact type
R222 L10 040	P07	Stainless steel passivated	Yes	Cylindrical

NARROW AND SQUARE FLANGE EXTENDED DIELECTRIC MALE PANEL RECEPTACLES

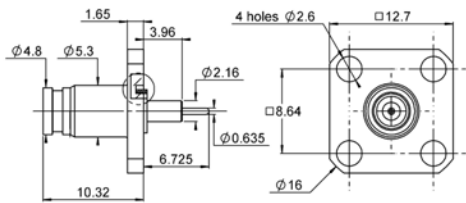

Fig. 1

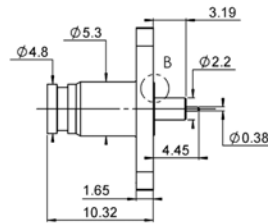
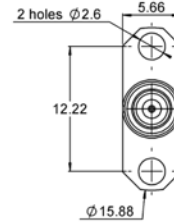
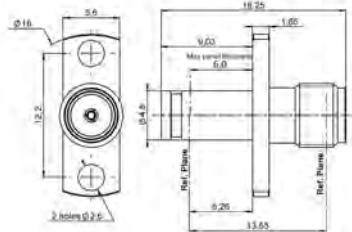

Fig. 2



Part number	Fig.	Panel drilling	Body & finish	Captive center contact	Panel mount	Contact type
R222 L10 010	1	P04	Brass gold plated	Yes	4-hole flange	Cylindrical
R222 L10 020	2	P05			2-hole flange	

ADAPTERS



Part number	Panel drilling	Body & finish	Captive center contact
R191 593 400	P03	Brass gold plated	Yes

Panel Drilling

P01

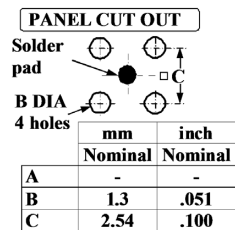

P02

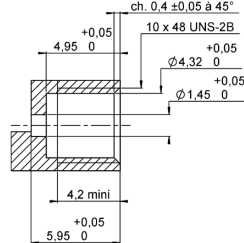

P03

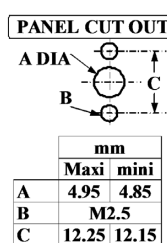

P04

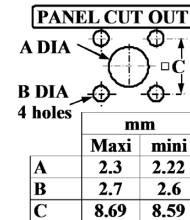

P05

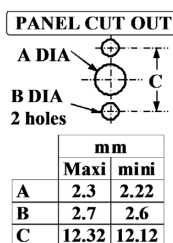

P06

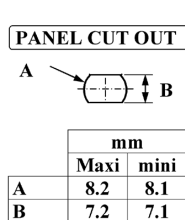

P07



## Characteristics

Test / Characteristics	Values / Remarks
------------------------	------------------

## ELECTRICAL CHARACTERISTICS

Impedance	50Ω	
Frequency range	DC - 6 GHz (optimized) DC - 12.4 GHz (working range)	
Typical V.S.W.R. • Straight styles • Right angle styles • Receptacles	DC - 2.5 GHz 1.10 1.15 1.06	2.5 - 6 GHz 1.15 1.25 1.10
Insertion loss (dB)	0.12 √F (F in GHz)	
Insulation resistance (MΩ)	5000	
Voltage rating (V.R.M.S.)	750	
RF leakage	-55 dB 0 to 3 GHz -40 dB from 3 to 6 GHz	

## MECHANICAL CHARACTERISTICS

	Smooth bore	Limited detent	Full detent
Mechanical endurance (matings)	100		
Engagement and separation force (N)	9 max. - 2.2 min.	45 max. - 9 min.	68 max. - 22 min.
Radial misalignment Axial misalignment	± 0.25 mm 0, +0.25 mm		
Moisture resistance	MIL-STD-202 method 106		
Cable retention (N) • .085" semi-rigid • 2/50/S • 2.6/50/S	200 35 58		
Contact captivation axial (N)	6.8		

## ENVIRONMENTAL CHARACTERISTICS

Operating temperature • Standard • Semi-rigid	-55°C / +125°C -55°C / +105°C
---	----------------------------------

## MATERIALS

Cable connectors	Beryllium copper or brass
Receptacles	Brass
In series adapters	Beryllium copper
Center contacts	Beryllium copper/brass
Insulators	PTFE/PEEK

## PLATING

Cable connectors	NPGR
Receptacles	NPGR
In series adapters	NPGR
Center contacts	NPGR



The SMP small size dramatically increases the packaging density of 40 GHz connections (see picture: SMA2.9/SMP).

Standard packaging = 100 pieces  
All dimensions are given in mm.



Plugs

**STRAIGHT PLUG, FULL CRIMP TYPE FOR FLEXIBLE CABLE (female center contact)**

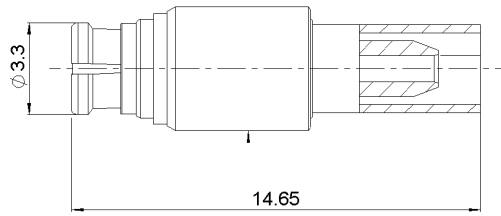

Cable group	Cable group dia.	Part number	Captive center contact
RG178/RG196	2/50/S	R222 900 100	Yes
RG174/RG316	2.6/50/S	R222 900 130	

**STRAIGHT PLUG, SOLDER TYPE (female center contact)**

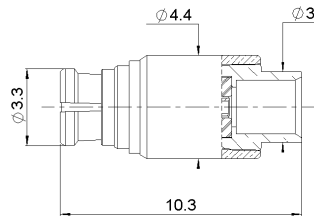

Cable group	Cable group dia.	Part number	Captive center contact
RG405	.085"	R222 900 200	No

**RIGHT ANGLE PLUGS, CRIMP TYPE FOR FLEXIBLE CABLE (female center contact)**

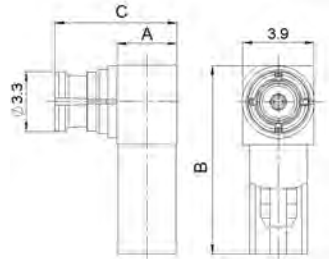

Cable group	Cable group dia.	Part number	Dimensions (mm)			Captive center contact
			A	B	C	
RG178/RG196	2/50/S	R222 900 310	3.3	10.3	6.7	Yes
RG174/RG316	2.6/50/S	R222 900 320	3.7	11.3	7	
RD316	2.6/50/D	R222 900 330		13.3	7.4	

**RIGHT ANGLE PLUG, SOLDER TYPE (female center contact)**

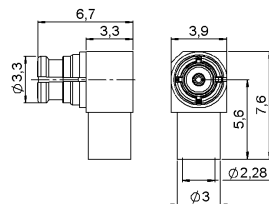

Cable group	Cable group dia.	Part number	Captive center contact
RG405	.085"	R222 900 340	Yes

Receptacles and Adapter

**STRAIGHT SMT RECEPTACLE (male center contact)**

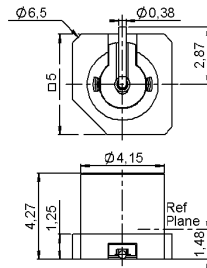

Part number	Retention	Captive center contact	Assembly instructions	Packaging
R222 941 100	Full detent	Yes	M01	Tape & Reel 500 pieces
R222 941 300	Limited detent			
R222 941 700	Smooth bore			

**STRAIGHT RECEPTACLES, PIN & PASTE MOUNT (male center contact)**

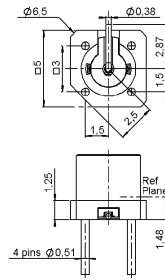
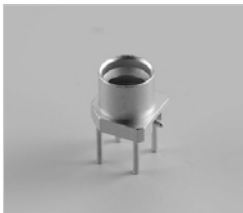

Part number	Retention	Captive center contact	Assembly instructions	Packaging
R222 940 100	Full detent	Yes	M01	Tape & Reel 500 pieces
R222 940 300	Limited detent			
R222 940 700	Smooth bore			

**IN SERIES ADAPTER (female to female center contact)**



Please refer to page 2-20

Measurement PCB

**MEASUREMENT PCB WITH SMT RECEPTACLE**

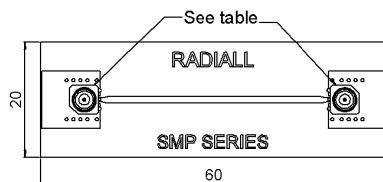
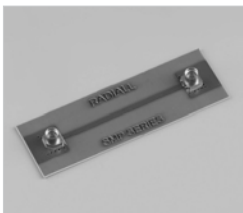

Part number	Packaging	Connector
R222 995 320	Unit	2 x R222 941 300

Packaging

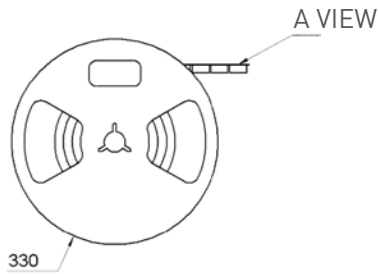

Part number	Packaging
R222 940 100	Tape & Reel 500 pieces
R222 940 300	
R222 940 700	
R222 941 100	
R222 941 300	
R222 941 700	

Connectors
R222 941 100
R222 941 300
R222 941 700

Connectors
R222 940 100
R222 940 300
R222 940 700

AIR SUNCTION

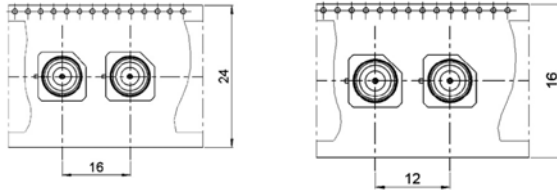
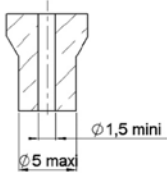

A VIEW

Assembly Instructions

M01

Connectors
R222 941 100
R222 941 300
R222 941 700

Connectors
R222 940 100
R222 940 300
R222 940 700

SOLDERING PATTERN

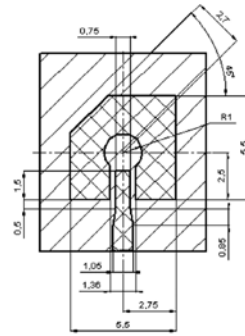
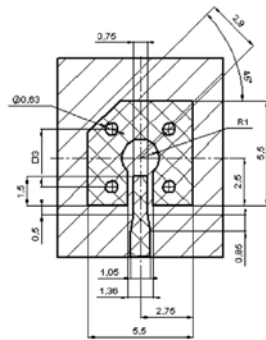

VIDEO SHADOW

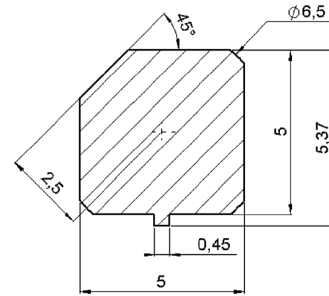

# NOTE





## BOARD-TO-BOARD: MMBX/SMP-MAX

*R223/R222M*

**Contents**

**MMBX**

Introduction ..... 3-4  
Interface ..... 3-5  
Characteristics ..... 3-6  
Plugs ..... 3-7  
PCB receptacles ..... 3-7 to 3-8  
Adapters ..... 3-9  
Demo board ..... 3-10  
Panel drilling ..... 3-10  
Assembly instructions ..... 3-10

**SMP-MAX**

Introduction ..... 3-11 to 3-12  
Characteristics ..... 3-13  
Jacks and plugs ..... 3-14  
Receptacles ..... 3-15 to 3-16  
Adapters ..... 3-17 to 3-18  
Panel Drilling ..... 3-18

**SECTION 3 TABLE OF CONTENTS**



## Introduction



50Ω

DC - 12.4 GHz

**GENERAL**

- Snap-on mating
- Microminiature coaxial connectors
- Robust
- Surface mount receptacles
- Fully compatible with automated pick and place machines

**APPLICATIONS**

- Board to board applications
- Base station
- High density packaging

MMBX™ connector series is particularly suitable for board to board connection in telecommunication systems. MMBX™ connectors allow a quick connection in a minimum space requirement. Frequency range is DC to 12.4 GHz. SMT connectors are totally compatible with pick and place machines.

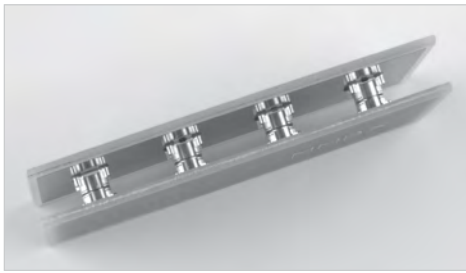
• **Space saving**

Its small size is a main advantage for applications requiring board to board distance less than 7mm.

• **Recommended use**

Receptacles and in-series adapters can be either sold separately or with the adapter already inserted in the receptacle. In this case, assembly time will be reduced and you will be sure that the in-series adapter is properly inserted.



Retention between receptacle and in-series adapter is ensured by the asymmetrical design of the adapter.

- Snap side: for board to board application, it allows all in-series adapters to remain on the same board during disassembly.
- Slide side: it allows quick and easy connections with large axial and radial misalignment tolerance.

PCB connectors

JACK

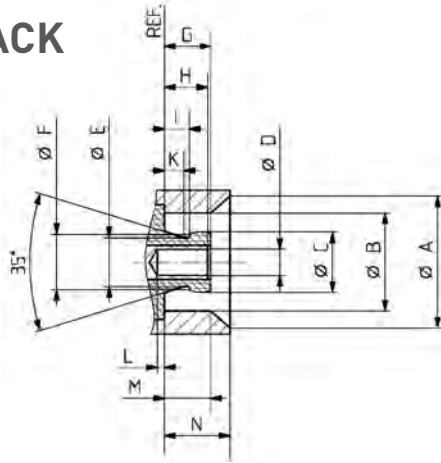

PLUG

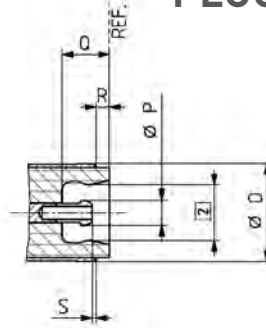

Letter	mm		inch	
	min.	max.	min.	max.
A	5.00 nom.	5.00 nom.	.197 nom.	.197 nom.
B	3.68	3.71	.145	.146
C	2.25	2.30	.088	.090
D	0.98	1.01	.038	.040
E	1.85 nom.	1.85 nom.	.073 nom.	.073 nom.
F	2.10 nom.	2.10 nom.	.083 nom.	.083 nom.
G	-	1.80	-	.071
H	1.55	1.75	.061	.069
I	0.90	-	.035	-

Letter	mm		inch	
	min.	max.	min.	max.
K	0.75 nom.	0.75 nom.	.029 nom.	.029 nom.
L	0	-	0	-
M	1.45	-	.057	-
N	2.50 nom.	2.50 nom.	.098 nom.	.098 nom.
O	3.70 nom.	3.70 nom.	.146 nom.	.146 nom.
P	0.95 nom.	0.95 nom.	.037 nom.	.037 nom.
Q	1.85 nom.	1.85 nom.	.073 nom.	.073 nom.
R	0.50 nom.	0.50 nom.	.020 nom.	.020 nom.
S	0.10 nom.	0.10 nom.	.004 nom.	.004 nom.

In series adapters

Slide-on

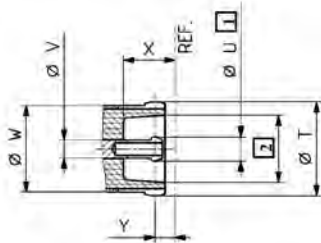

Snap-on

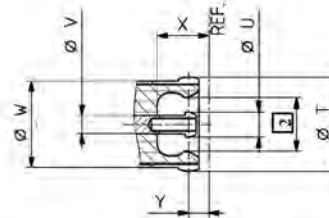

Letter	mm	inch
T	3.70 nom.	.146 nom.
U	0.95 nom.	.037 nom.
V	0.70 nom.	.027 nom.

Letter	mm	inch
W	3.65 nom.	.144 nom.
X	2.05 nom.	.080 nom.
Z	0.80 nom.	.031 nom.

- 1 Slotted and flared to meet electrical and mechanical requirements
- 2 Dimension to meet electrical and mechanical requirements

## Characteristics

Test / Characteristics	CECC 22000	Values / Remarks			
<b>ELECTRICAL CHARACTERISTICS</b>					
Impedance	-	50Ω			
Frequency range	-	DC - 12.4 GHz			
Typical V.S.W.R. <ul style="list-style-type: none"> <li>• Straight connectors:               <ul style="list-style-type: none"> <li>- 2/50/S</li> <li>- 2.6/50/S</li> <li>- 2.6/50/D</li> </ul> </li> <li>• Right angle connectors:               <ul style="list-style-type: none"> <li>- 2/50/S</li> <li>- 2.6/50/S</li> <li>- 2.6/50/D</li> </ul> </li> </ul>		DC - 1 GHz	1 - 2.5 GHz	2.5 - 6 GHz	
			1.05	1.06	1.10
			1.05	1.06	1.10
		-	1.05	1.06	1.10
			1.05	1.13	1.22
			1.05	1.06	1.17
Insulation resistance	-	> 1 GΩ			
Dielectric withstanding voltage (sea level) <ul style="list-style-type: none"> <li>• 2.50</li> <li>• 2.6/50</li> </ul>	4.4.5	500 Vrms. 50 Hz 750 Vrms. 50 Hz			
Contact resistance <ul style="list-style-type: none"> <li>• Center contact</li> <li>• Outer contact</li> </ul>	4.4.2 4.4.3	≤ 5 mΩ ≤ 1 mΩ			

## MECHANICAL CHARACTERISTICS

Mechanical endurance	4.7.1	100 matings
Engagement and separation force <ul style="list-style-type: none"> <li>• Engagement</li> <li>• Separation</li> </ul>	4.5.4	30 N max 8-30 N
Contact captivation	4.5.2	≥ 10 N
Cable retention force <ul style="list-style-type: none"> <li>• 2/50</li> <li>• 2.6/50</li> </ul>		58 N 110 N
Vibration	4.6.3 - IEC 68-2-6 Fc	MIL-STD-202, Method 204 D, condition A

## ENVIRONMENTAL CHARACTERISTICS

Temperature range	-	-55°C + 155°C
Thermal shock	4.6.7 - IEC 68-2-14 Na	MIL STD 202, method 107G, condition B1
Moisture resistance	4.6.6 - IEC 68-2-3 Ca	MIL STD 202, method 106F
Corrosion	4.6.10 - IEC 68-2-11 Ka	MIL STD 202, method 101, condition B
Vibration	4.6.3 - IEC 68-2-6 Fc	MIL STD 202, method 204D, condition A

## MATERIALS

Center & outer contacts	-	Beryllium copper
Bodies	-	Brass
Ferrules	-	Copper
Insulators	-	PTFE

## PLATING

Center & outer contacts	-	Gold / NPGR
Bodies	-	NPGR
Ferrules	-	NPGR

All dimensions are given in mm.  
Standard packaging = 100 pieces.

Plugs and PCB Receptacles

**STRAIGHT PLUGS (male center contact)**

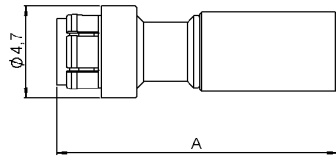
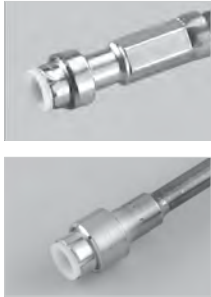

Fig. 1

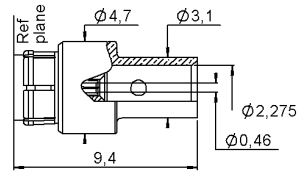

Fig. 2

Cable group	Cable group dia.	Part number	Fig.	A	Captive center contact	Note
RG178 / RG196	2/50/S	R223 081 000	1	14.3	Yes	Crimp type for flexible cables
RG174 / RG316	2.6/50/S	R223 082 000		14.5		
RG316	2.6/50/D	R223 083 000				
RG405	.085"	R223 062 000	2	-		Solder type for semi-rigid cables

**RIGHT ANGLE PLUGS (male center contact)**

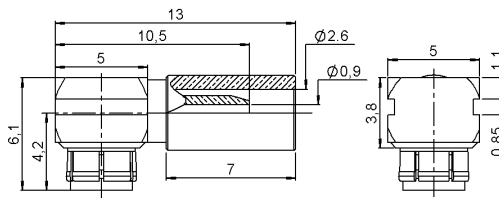

Fig. 1

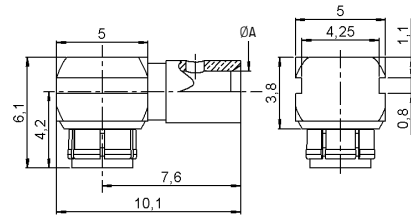

Fig. 2

Cable group	Cable group dia.	Part number	Fig.	A	Captive center contact	Note
RG178 / RG196	2/50/S	R223 181 000	1	-	Yes	Crimp type for flexible cables
RG174 / RG316	2.6/50/S	R223 182 000				
RG316	2.6/50/D	R223 183 000				
RG405	.085"	R223 162 000	2	2.275		Solder type for semi-rigid cables

**STRAIGHT PCB RECEPTACLES WITH PRE-ASSEMBLED ADAPTER (male center contact)**

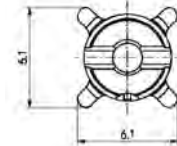

Fig. 1

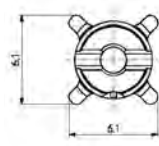

Fig. 2

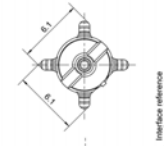
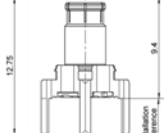
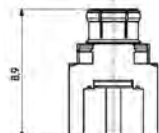
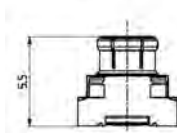

Fig. 3



Part number	Fig.	Captive center contact	PCB	Assembly instructions	Packaging	Note
R223 434 000	1	Yes		M01	Bulk 100 pieces	SMT
R223 434 800					Tape & Reel 750 pieces	
R223 435 000	2		P01	-	Bulk 100 pieces	-
R223 435 010	3			-		-

PCB Receptacles

**EDGE CARD PCB RECEPTACLES (female center contact)**

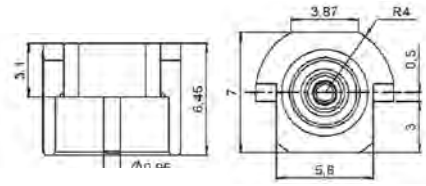

Part number	Captive center contact	Packaging	Note
R223 423 010	Yes	Bulk 100 pieces	SMT
R223 423 800		Tape & Reel 650 pieces	

**STRAIGHT PCB RECEPTACLES (female center contact)**

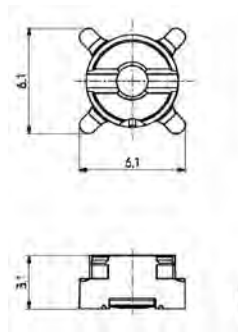

Fig. 1

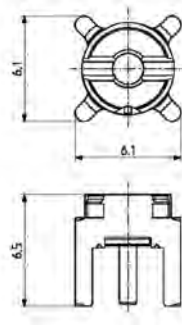

Fig. 2

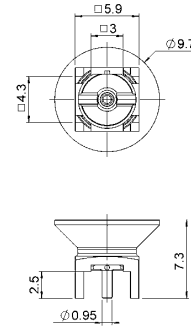

Fig. 3

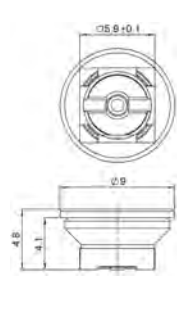
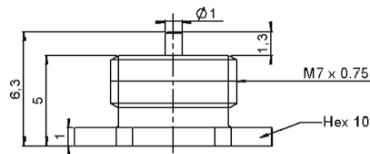
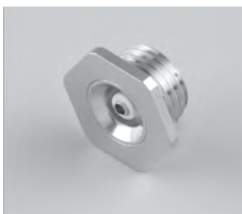

Fig. 4

Part number	Fig.	Captive center contact	PCB	Assembly instructions	Packaging	Note	
R223 424 000	1	Yes	-	M01	Bulk 100 pieces	SMT	
R223 424 800					Tape & Reel 750 pieces		
R223 424 870	4			-	Bulk 100 pieces	Catcher's mitt	
R223 425 000	2			P01	-	Bulk 100 pieces	-
R223 425 800				-	-	Tape & Reel 500 pieces	-
R223 425 810	3			-	-	-	Catcher's mitt

**SCREW-ON RECEPTACLE (female center contact)**



Part number	Captive center contact	Panel drilling
R223 555 000	Yes	P02

Adapters

**IN SERIES ADAPTERS (male-male center contact)**

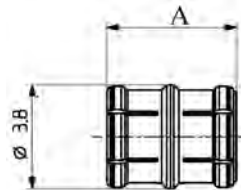

Fig. 1

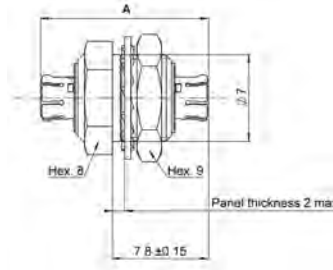

Fig. 2

Part number	Fig.	Length A (mm)	Type	Nominal Board-to-Board distance
R223 703 180	1	4.8	Snap-slide	6.7
R223 703 020		9.7	Slide-slide	11.7
R223 703 040		12		14
R223 703 080		7	Snap-slide	9
R223 703 230		20.4		22.4
R223 720 020	2	13.6	Slide-slide Bulkhead	-

Other lengths available, please contact us.

**BETWEEN-SERIES ADAPTERS**

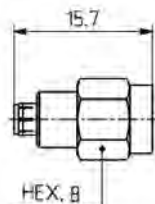

Fig. 1

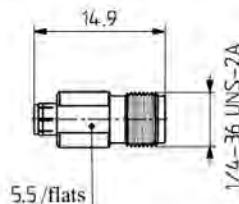

Fig. 2

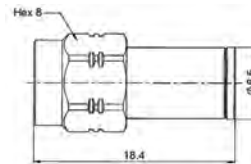

Fig. 3

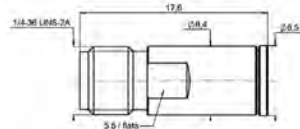

Fig. 4

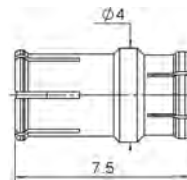

Fig. 5

Part number	Fig.	Series	Packaging
R191 389 100	1	MMBX male / SMA male	Unit
R191 389 200	2	MMBX male / SMA female	
R191 389 300	3	MMBX female / SMA male	
R191 389 400	4	MMBX female / SMA female	
R191 560 000	5	SMP-MAX female / MMBX male snap	Bulk 100 pieces

Other configurations available, with flange, straight and right angle. Please contact us.



## Demo Board



Part number	Note
R223 990 000	2 SMT receptacles

## Panel Drilling

### P01

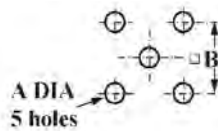

	mm		inch	
	maxi	mini	maxi	mini
A	1.4	1.2	.055	.047
B	5.16	5	.203	.197

### P02



Threading	
ØA	M7 x 0.75

## Assembly Instructions

### M01

Part number					
R223 424 000	R223 424 800	R223 434 000	R223 434 800	R223 435 000	R223 435 010

### COPLANAR LINE

- Pattern and signal are on the same side.
- The material of PCB is epoxy resin (FR4) (Er = 4.6).
- The solder resist should be printed except for the land pattern on the PCB.

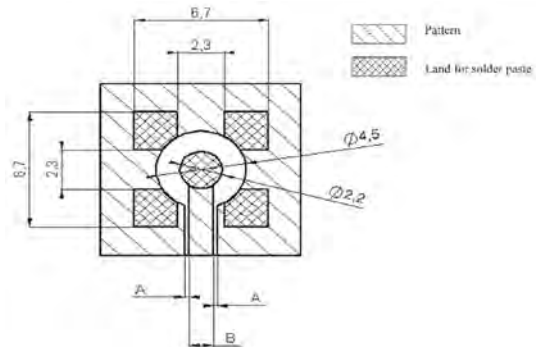

### APPLICATION 75Ω WITH B = 0.55 mm

PCB thickness (mm)	Coplanar line A (mm)
0.8	0.350
1.0	0.360
1.2	0.365
1.6	0.375

### APPLICATION 50Ω WITH B = 1.2 mm

PCB thickness (mm)	Coplanar line A (mm)
0.8	0.190
1.0	0.200
1.2	0.205
1.6	0.210

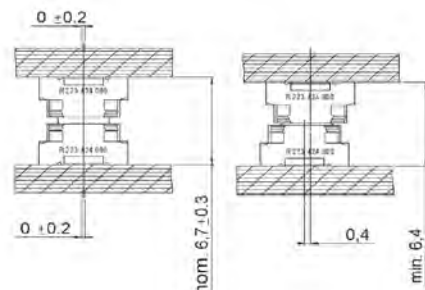
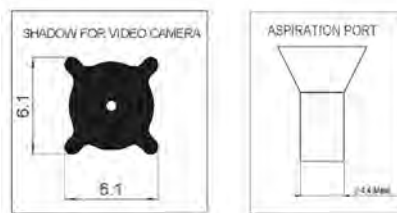

Not valid for R223 424 870, please consult data sheet.

## Introduction

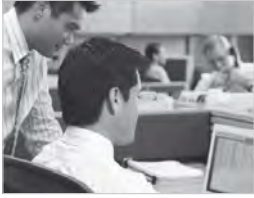

### Board-to-Board solutions

#### The Best Systems

Radiall's engineers work with your engineers, allowing us to develop the best competitively priced misalignment RF coaxial interconnect solutions on the market today.

#### The Best Choices

Radiall offers more board to board choices with four different product groups and ten connector series, that can address the most demanding wireless telecom applications required for the new generation of infrastructure compact equipment. From base stations to repeaters and even handheld and GPS devices, we have a tailored connector solution for you, including the new SMP-MAX, SMP-Spring, IMP-Spring and other large, limited and no misalignment solutions.



#### SMP-MAX



SMP-MAX  
Receptacle

Get the best for less with the new SMP-MAX large misalignment solution. Its patented impedance matching insulator is optimized for a larger operating gap between connectors making it easier for engineers to handle a board-to-board distance tolerance of at least .078" (2.0 mm) without a spring, which is 300% more than the standard SMP. It features a 3° minimum tilt (radial travel) and it has an operating frequency range of DC-6 GHz and a 1.2 max VSWR guaranteed at DC-3 GHz.



SMP-MAX Adapter

#### Spring-loaded Connectors

Radiall's one connector IMP-Spring and three connector SMP-Spring, MMBX-Spring, and BMR-Spring large misalignment spring-loaded series are the best for increased maximum distance tolerances. IMP-Spring is a cost effective, unique one connector solution that offers up to .023" (.6 mm) board to board distance tolerance with a tilt (radial travel) up to 4.5°. The new SMP-Spring and MMBX-Spring offer up to .078" (2 mm) board-to-board distance tolerance and a 4.5° tilt (radial travel). All spring-loaded solutions feature consistent VSWR and low RF leakage.



IMP-Spring and SMP-Spring



IMP

#### Limited Misalignment

Radiall's one connector IMP and three connector SMP and MMBX limited misalignment series are designed for applications requiring relatively precise distance tolerance of up to .023" (.6 mm) with a tilt (radial travel) of up to 4.5°.

#### No Misalignment

Radiall's MMT, MMS and MCX series are designed for applications requiring little or no distance tolerance between boards.

## Introduction

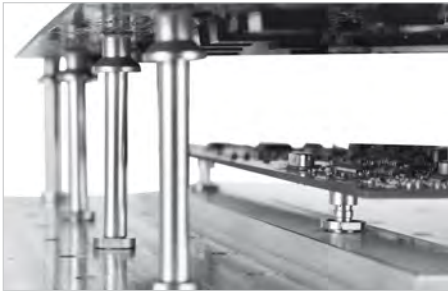

50Ω	DC - 6 GHz
-----	------------

### GENERAL

- Microminiature coaxial connectors
- Power up to 300 Watts
- Board-to-Board distance misalignment of at least 0.078" (2.0 mm)
- Tilt (radial misalignment): 3° minimum
- 1.2 max VSWR at DC - 3 GHz

### APPLICATIONS

- Broadcast
- RF components (filters, amplifiers, ....)
- Wireless communications

### The cost-effective solution for maximum mechanical misalignment

Of the several RF connectors available for interconnections in wireless remote radio heads, repeaters, base stations, GPS devices, and similar applications, the Board-to-Board style connector is growing in popularity. The product line has evolved from accommodating limited misalignment to offering the widest tolerances available.

SMP-MAX was introduced by Radiall to provide larger misalignment tolerances than the early version board-to-board connectors like SMP or SMP-spring while offering lower cost.

Featuring an optimized interface, SMP-MAX can work up to 6 GHz Board-to-Board distance misalignment at least 2.0 mm and radial misalignment 3° minimum.

The SMP-MAX series offers 2 levels of retention provided by the receptacles:

- Slide-on, for the lowest retention
- Snap-on, for a positive locking with a retention

A complete SMP-MAX Board-to-Board system is made of 3 parts:

SMP-MAX Slide-on receptacle	SMP-MAX In series adapter	SMP-MAX Snap-on receptacle
		

Many other custom configurations are available. Larger distance misalignment and larger tilt versions are also available.

## Characteristics

Test / Characteristics	Values / Remarks		
<b>ELECTRICAL CHARACTERISTICS</b>			
Impedance	50Ω		
Frequency	DC - 6 GHz		
Typical V.S.W.R. (Board-to-Board connection)	Misalignment	DC - 3 GHz	3-6 GHz
	Radial 0°, Axial 0 mm	< 1.15	< 1.25
	Radial 0°, Axial +/- 1 mm	< 1.20	< 1.35
	Radial 3°, Axial 0 mm	< 1.15	< 1.25
	Radial 3°, Axial +/- 1 mm	< 1.20	< 1.35
Insertion loss (Board-to-Board connection)	Misalignment	DC - 3 GHz	3-6 GHz
	Radial 0°, Axial 0 mm	0.10	0.15
	Radial 0°, Axial +/- 1 mm	0.12	0.25
	Radial 3°, Axial 0 mm	0.10	0.15
	Radial 3°, Axial +/- 1 mm	0.12	0.25
Insulation resistance	5000 MΩ		
Center contact resistance	< 3 mΩ		
Outer contact resistance	< 1.5 mΩ		
Working voltage	330 VRMS		
Dielectric withstanding voltage	1000 VRMS		
Power handling (typical)	> 300W @ 2.7 GHz, 25°C > 200W @ 2.7 GHz, 85°C		
RF leakage	-70dB to 3 GHz, axial misalignment 0mm		

## MECHANICAL CHARACTERISTICS

Mating cycles	100 cycles	
	Slide-on	Snap-on
Engagement force	< 14 N	< 45 N
Disengagement force	< 9 N	> 9, < 45 N
Center contact retention force	> 7 N	
Minimum distance between PCB	13 mm	
Radial misalignment tolerance	3°min	
Axial misalignment tolerance	2.0 mm Larger axial misalignment version available	

## ENVIRONMENTAL CHARACTERISTICS

Temperature range	-55°C / +165°C
Thermal shock	MIL-STD-202, method 107, condition B
Vibration	MIL-STD-202, method 204, condition B
Shock	MIL-STD-202, method 213, condition A
Corrosion salt spray	MIL-STD-202, method 101, condition B
Moisture resistance	MIL-STD-202, method 106

## MATERIALS

Body	Brass / Beryllium copper
Male center contact	Brass
Female center contact	Beryllium copper
Gasket	Silicon rubber
Insulator	PTFE / PEEK

## PLATING

Body	NPGR / BBR
Male center contact	NPGR
Female center contact	NPGR

Packaging = 100 pieces box / 500 pieces reel.  
All dimensions are given in mm.

Jacks, Plugs and Cabling

**BULKHEAD STRAIGHT SLIDE-ON MALE JACKS FOR CABLES**

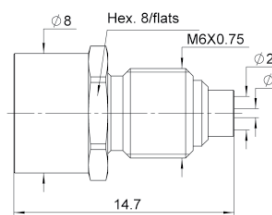

Fig. 1

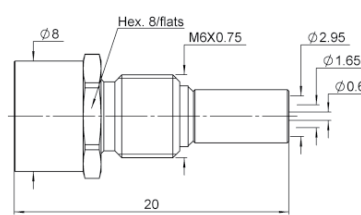
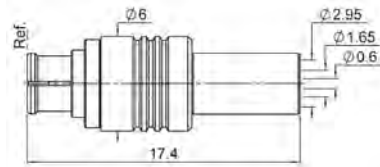

Fig. 2

Cable group	Cable group dia.	Part number	Fig.	Captive center contact	Panel drilling	Packaging
RG405	.085"	R222 M20 700	1	Yes	P01	Bulk 100 pieces
RG174 / RG316	2.6/50/S	R222 M20 710	2			

**STRAIGHT FEMALE PLUG FOR FLEXIBLE CABLE**



Cable group	Cable group dia.	Part number	Captive center contact	Packaging
RG174 / RG316	2.6/50/S	R222 M80 400	Yes	Bulk 100 pieces

**RIGHT ANGLE FEMALE PLUG FOR FLEXIBLE CABLE**

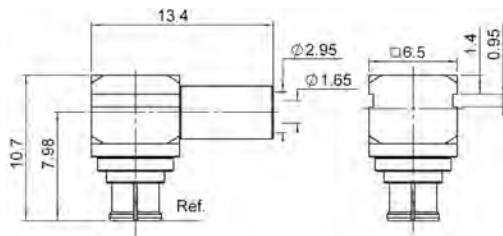

Fig. 1

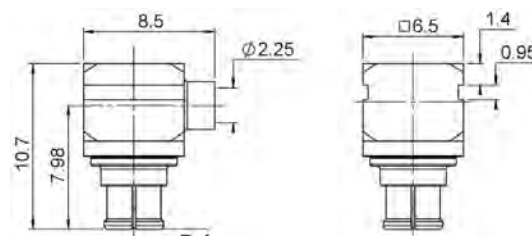
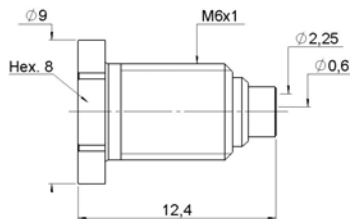

Fig. 2

Cable group	Fig.	Cable group dia.	Part number	Captive center contact	Packaging
RG174 / RG316	1	2.6/50/S	R222 M80 500	Yes	Bulk 100 pieces
RG405	2	.085"	R222 M80 517		

**BULKHEAD MALE JACK SNAP TYPE**



Cable group	Cable group dia.	Part number	Captive center contact	Panel drilling	Packaging
RG405	.085"	R222 M20 017	No	P05	100

Receptacles

STRAIGHT SLIDE-ON MALE RECEPTACLES



Fig. 1



Fig. 2

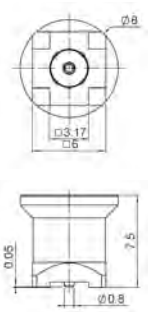

Fig. 3



Fig. 4

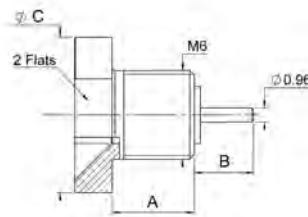

Fig. 5

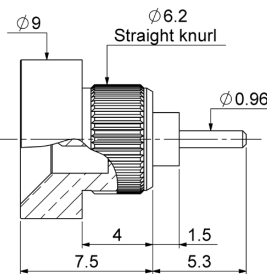

Fig. 6

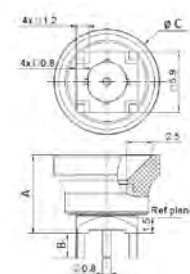

Fig. 7

Part number	Fig.	Dimensions (mm)			Captive center contact	Panel drilling	Packaging	Note	
		A	B	C					
R222 M00 700	1	-	-	-	Yes	-	Tape & Reel 500 pieces	SMT	
R222 M00 720	2	7.5	1.9	8.3		P02	Bulk 100 pieces	Solder legs	
R222 M00 770		8.4	3.4	10		-		Center contact dia. 0.95	
R222 M00 730	4	7.7	1.9	8.3		P03	Tape & Reel 400 pieces	PIH + SMT, with cap	
R222 M00 740	3	-	-	-		-	Tape & Reel 500 pieces	SMT	
R222 M10 700	5	5.6	2	9		P01	Bulk 100 pieces	Screw-on	
R222 M10 730	6	-	-	-		P04		Press in	
R222 M10 750	5	5.6	4	10.5		P01		-	
R222 M00 790	4	13.3	1.9	12		P03		PIH + SMT	
R222 M00 860	2	7.3	3.5	10		P02		Bulk 100 pieces	Solder legs
R222 M00 880		7.7	2.4						PIH + SMT
R222 M00 890	4	7.2	1.7	-		-	500	Composite catcher's mitt / SMT	
R222 M03 700	7	7.6	0	10.2		-	Bulk 100 pieces	Composite catcher's mitt / Solder legs	
R222 M03 880		7.7	2.4	10		P02			



Receptacles

STRAIGHT SNAP-ON MALE RECEPTACLES

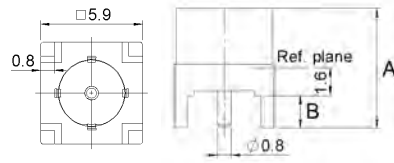

Fig. 1

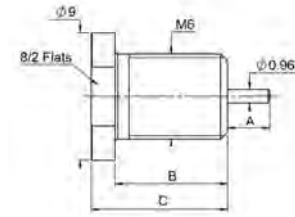

Fig. 2

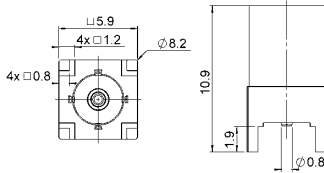

Fig. 3

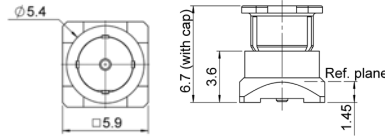

Fig. 4

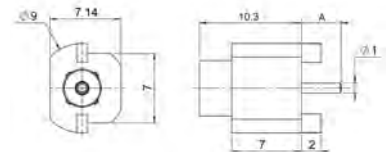

Fig. 5

Part number	Fig.	Dimensions (mm)			Captive center contact	Panel drilling	Packaging	Note
		A	B	C				
R222 M10 000	2	2	7.1	11.15	Yes	P01	Bulk 100 pieces	Screw-on, with cap
R222 M10 030		3.5	9.1	11.2				
R222 M10 060		4.1	6.5	8.5				
R222 M00 080	1	7	1.9	-		P02	-	Solder legs
R222 M00 090	3	-	-	-		P03	Tape & Reel 500 pieces	PIH + SMT, with cap
R222 M00 160	1	8.6	3.5	-		P02	-	-
R222 M01 000		6.7	1.7	-		-	Bulk 100 pieces	Solder legs
R222 M01 040	3	-	-	-		P03	Bulk 400 pieces	PIN + SMT
R222 M01 090	5	4	-	-		-	Tape & Reel 500 pieces	Edge type
R222 M01 140		3	-	-		-	Bulk 100 pieces	
R222 M03 000	4	-	-	-	P05	Tape & Reel 500 pieces	Screw-on	

Adapters

IN-SERIES BOARD-TO-BOARD ADAPTERS

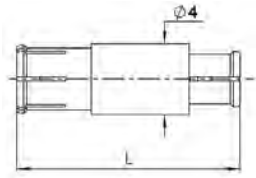

Fig. 1

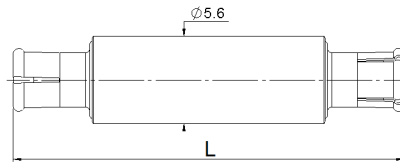
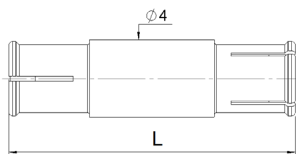

Fig. 2

Part number	Lenght L (mm)	Fig.	Series	Packaging
R222 M40 010	9.5	1	SMP-MAX female / SMP-MAX female	Bulk 100 pieces
R222 M40 050	25.3			
R222 M40 060	12.15			
R222 M40 070	14.9			
R222 M40 080	13.8			
R222 M43 052	25.3	2		
R222 M43 072	14.9			
R222 M43 112	16.7			
R222 M43 192	50.5			
R222 M43 202	45.2			
R222 M43 212	46.25	1		
R222 M43 222	51.15			
R222 M43 262	67.5			
R222 M46 012	9.5			
R222 M46 032	7.2			
R222 M46 047	19.12	1		
R222 M46 062	12.15			
R222 M46 072	14.9			
R222 M46 102	22.86			
R222 M46 147	15.6			
R222 M46 307	29.39			
R222 M46 317	8.8			

BETWEEN-SERIES BOARD-TO-BOARD ADAPTERS



Part number	Lenght L (mm)	Series	Packaging
R191 996 110	12.6	SMP-MAX female / SMP female	Bulk 100 pieces
R191 996 130	8.9		
R191 560 000	7.5	SMP-MAX female / MMBX male snap	

## Adapters

### BETWEEN-SERIES ADAPTERS

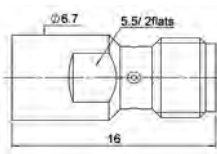

Fig. 1

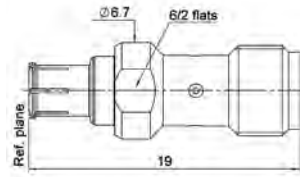
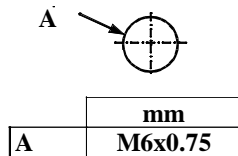

Fig. 2

Part number	Fig.	Series	Packaging
R191 552 000	1	SMP-MAX male / SMA female	Unit
R191 553 000	2	SMP-MAX female / SMA female	

## Panel Drilling

### P01



### P02

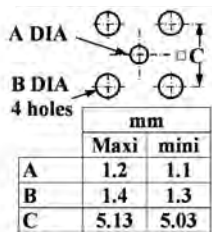

### P03

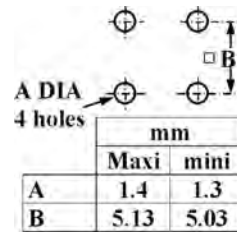

### P04

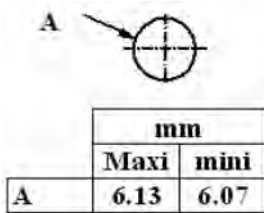

### P05

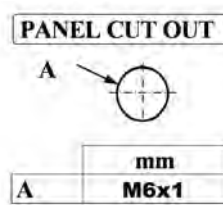



## COAXIPACK 2

R694

**Contents**

**COAXIPACK 2**

Introduction .....	4-4 to 4-5
Characteristics .....	4-6
PCB modules .....	4-7 to 4-9
Feedthrough male cable assembly .....	4-10
Feedthrough male male adapter kits .....	4-11
Cable assembly .....	4-12 - 4-13
Samples and guide pins .....	4-14
Extraction procedures .....	4-15

**SECTION 4 TABLE OF CONTENTS**

## Introduction

The Coaxipack 2 series has been designed in accordance with the IEC 61076-4-104 (standard 2mm geometry system). Coaxipack 2 provides high density coaxial connectors aimed at high speed and space saving applications. The Coaxipack 2 series is available in 50Ω and 75Ω.

## APPLICATIONS

### 50Ω RANGE

- Telecom / Datacom (Transmission equipment, Satellite Communication Systems, Base station)
- Medical
- Networking industry
- Instrumentation

### 75Ω RANGE

- High speed data network
- Digital Broadcast System (Routers, Switching and Control Systems, Monitoring and Signal Measurement, Encoders etc...)

## FEATURES AND BENEFITS

Coaxipack 2 combines high performance miniature coaxial connectors with the convenience, compactness and cost effectiveness of 2mm metric systems.

## FEATURES

- Excellent for coaxial signal transmission: Low crosstalk, low signal distortion, high level of EMI/RFI shielding
- High speed performance: Minimum reflection and propagation delay, sub-nanosecond rise time capabilities
- Ruggedized for a variety environments: Industrial applications, humidity, shock, vibration...

## BENEFITS

- Space savings on PCB, reduced PCB routing complexity and supplies adequate spacing for high speed routing.
- Stackable with other 2mm metric modules (ex: power, signal) from most manufacturers.
- Maximum flexibility in system architecture due to Coaxipack's modular design-system designers are able to upgrade designs and add new functions without having to adopt major changes in the hardware configuration.

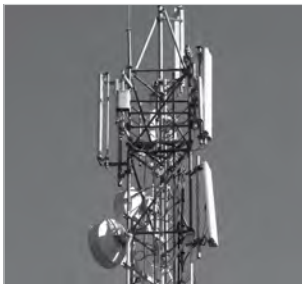
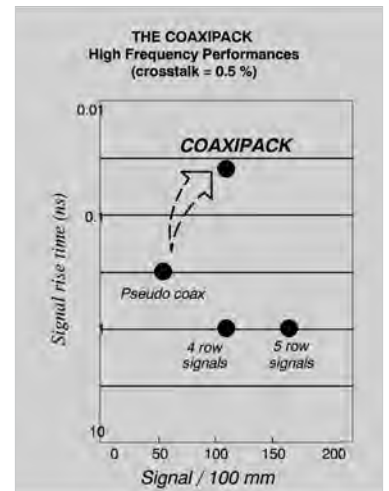

## Introduction

### MODULE

- Radiall offers a large range of pre-assembled modules. The term "module" is used for Coaxipack 2 connector mounting on board configuration.
- One module combines a housing including one or more inserts. The number of inserts depends on the required configuration, up to 6 contacts.



- Depending on the part number, one insert is made of one or two coaxial contacts.



### CABLE ASSEMBLIES

Radiall offers a standard kit including straight female insert and housing which fully complies with the IEC 61076-4-104.

### TECHNOLOGY BREAKTHROUGH INNOVATION

- **Interface:** Robust guidance and mating tolerances with reinforced interface provides a perfect alignment without any risk of loss of contact.
  - Male: New chamfers on outer contact and new radius on center contact for improved guidance
  - Female: New chamfered and extended insulator prevents any misalignment in very high density applications
- **Packaging:** Improved design of packaging to secure the connectors and prevent any damage during the transportation or handling. All connectors are shipped in a tray for safety during transportation and an added convenience during the manufacturing process.

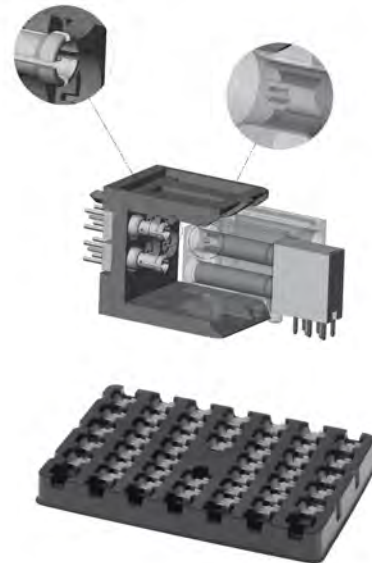

### ORDERING GUIDE

- **Connector choice**  
Radiall offers either ready to use modules (housing + inserts) or cable assembly kits.
- **Shielded connectors**  
Additional choices with two ways of plating to improve the shielding level:
  - (1) Addition of metal plates to the plastic housing
  - (2) Metallization of the plastic housing



## Characteristics

## ELECTRICAL CHARACTERISTICS

Frequency range	DC-3 GHz (Optimized) - (Working range up to 6 GHz)	
Impedance	50Ω and 75Ω	
V.S.W.R mated pair for <ul style="list-style-type: none"> <li>• PCB modules</li> <li>• Straight female - cable assembly</li> <li>• Straight male - cable assembly</li> </ul>	DC-1 GHz < 1.08 < 1.15 < 1.13	1-3 GHz < 1.12 < 1.30 < 1.20
Insertion loss mated pair	0.2 dB typical from 0 to 3 GHz	
RF leakage	-35 dB at 3 GHz	
Voltage rating	500 V	
Dielectric withstanding voltage	750 V	
Insulation resistance	≥ 5000 MΩ	
Contact resistance <ul style="list-style-type: none"> <li>• Center contact</li> <li>• Outer contact</li> </ul>	Initial	After environment test
	< 5 mΩ	< 15 mΩ
	< 2.5 mΩ	< 7.5 mΩ
Rise time degradation (corrected for board effects) at 300ps	6 ps	
Difference in propagation delay between shortest and longest line	26 ps	
Near end crosstalk at 300ps	0.2 %	

## MECHANICAL CHARACTERISTICS

Mating cycles	500
Insertion force	2.5 N
Extraction force	2.2 N
Contact density	2 to 6 contacts per module 60 contacts per 120 mm x 16 mm

## ENVIRONMENTAL CHARACTERISTICS

Temperature range	-25 / +125°C
-------------------	--------------

## MATERIALS

Housing	Liquid Crystal Polymer (LCP) glass filled
Bodies & contacts	Brass or bronze (see technical data sheet for details)
Insulators	PTFE / PEEK
Spring contacts	Beryllium copper

## PLATING

Coaxial contacts	NPGR
------------------	------

PCB Modules

RIGHT ANGLE FEMALE PCB MODULES (50Ω)

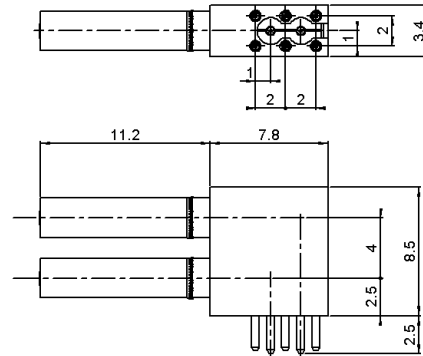
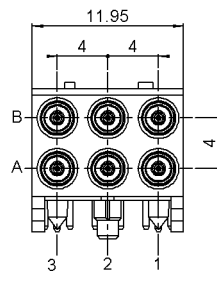
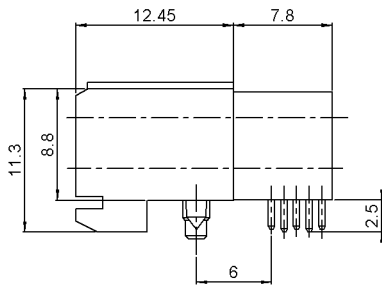
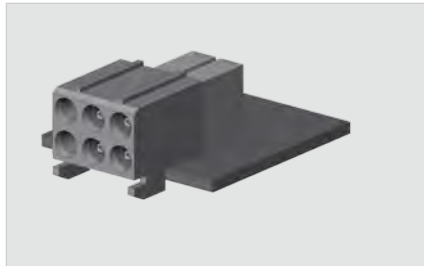
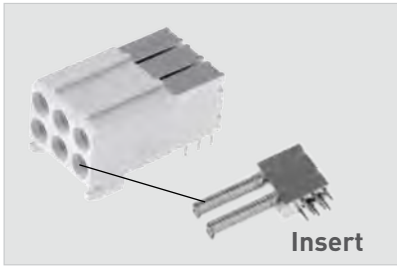

Recommended PCB thickness: 1.6 mm

Insert  
(not sold separately)

Number of contacts	Position	Part number	Packaging (pieces/tray)
2		R694 252 101	50
		R694 252 102	
		R694 252 103	
4		R694 252 104	
		R694 252 105	
		R694 252 106	
6		R694 252 107	

PCB Modules

## STRAIGHT MALE PCB MODULES (50Ω)

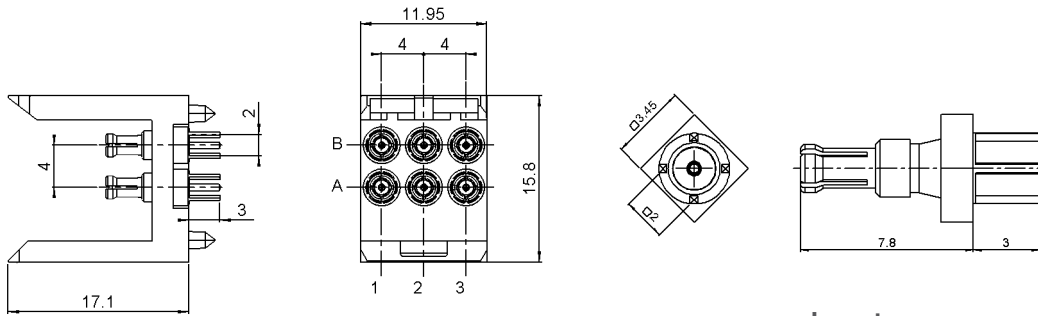
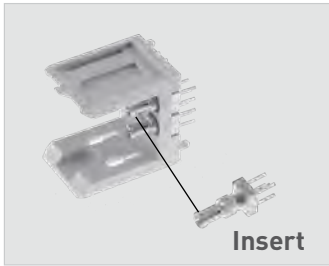

Recommended PCB thickness: 2 mm max

**Insert**  
(not sold separately)

Number of contacts	Position	Part number	Packaging (pieces/tray)
2		R694 251 021	50
		R694 251 022	
		R694 251 023	
4		R694 251 024	
		R694 251 025	
		R694 251 026	
6		R694 251 027	

PCB Modules

RIGHT ANGLE MALE PCB MODULES (50Ω and 75Ω)

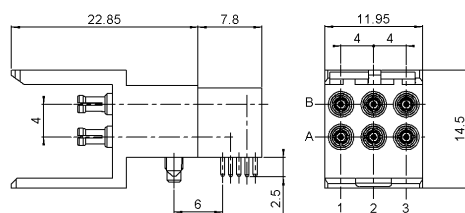
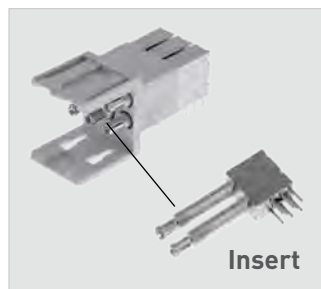

Recommended PCB thickness for 50Ω: 1.6 mm  
for 75Ω: 2.4 mm

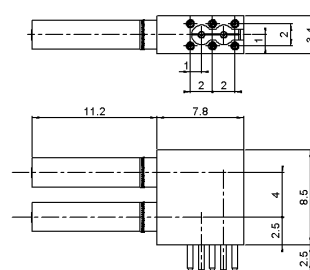

Insert  
(not sold separately)

50Ω					
Number of contacts	Position of insert	Part number <sup>(1)</sup>	Dimension a (mm)	Extraction procedure	Packaging (pieces/tray)
2		R694 251 111	2.5	U01	25
		R694 251 112			
		R694 251 113			
4		R694 251 114			
		R694 251 115			
		R694 251 116			
6		R694 251 117			

75Ω					
Number of contacts	Position of insert	Part number <sup>(2)</sup>	Dimension a (mm)	Extraction procedure	Packaging (pieces/tray)
2		R694 281 251	3.3	U01	25
		R694 281 252			
		R694 281 253			
4		R694 281 254			
		R694 281 255			
		R694 281 256			
6		R694 281 257			

NOTE:

(1) Housing is available in shielded version. For specific request, please consult sales

(2) With shielded version.

Feedthrough Male Cable Assembly



STRAIGHT MALE HOUSING

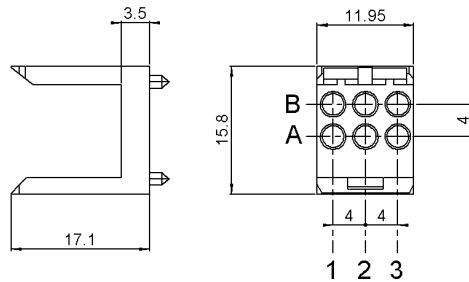
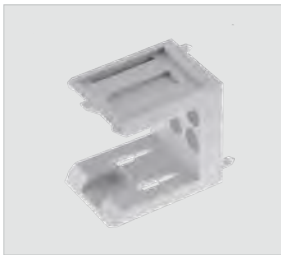

Part number	Note
R694 261 906	For removable inserts (not included)

STRAIGHT MALE REMOVABLE INSERTS, FULL CRIMP TYPE

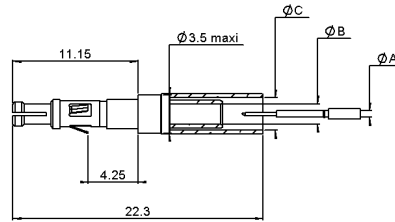

Cable group	Cable group dia.	Part number	Dimensions (mm)			Recommended PCB thickness (mm)	Extraction procedure
			A	B	C		
RG178	2/50/S	R199 001 203	0.4	1	2.55	3.2 ± 0.1	U01
RG174	2.6/50/S	R199 001 223	0.6	1.8	2.92	3.2 ± 0.1	

7 different possible configurations

2 Inserts			4 Inserts			6 Inserts

Feedthrough Male - Male Adapter Kits

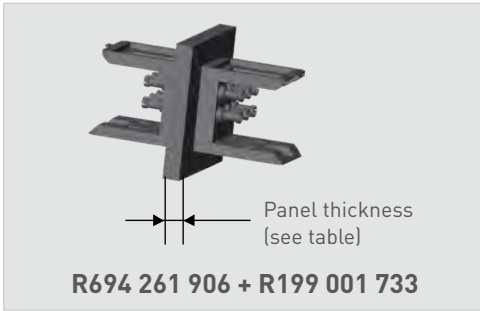

FOR REMOVABLE INSERT (50Ω)

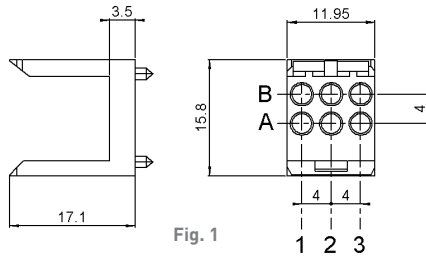
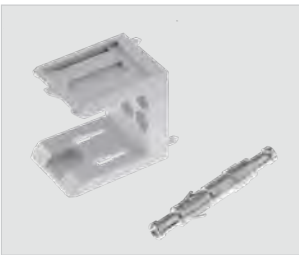

Fig. 1

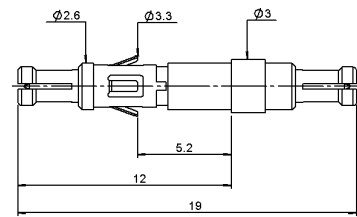

Fig. 2

Designation	Part number	Fig.	Panel thickness (mm)	Extraction procedure
Housing	R694 261 906 <sup>(1)</sup>	1	-	-
Male - Male insert	R199 001 733	2	3.2 ± 0.05	U01

FOR NON REMOVABLE INSERT (50Ω)

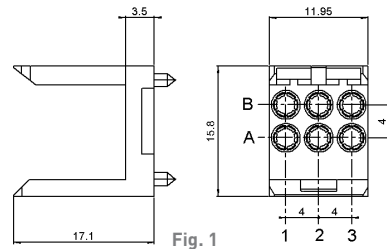
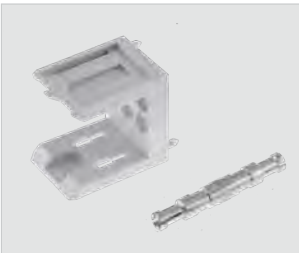

Fig. 1

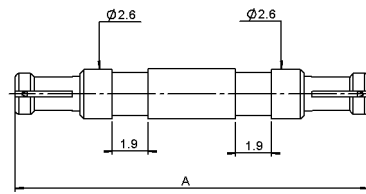

Fig. 2

Designation	Part number	Fig.	Dimension A (mm)	Panel thickness (mm)
Housing	R694 261 076 <sup>(1)</sup>	1	-	-
Non removable insert <sup>(2)</sup>	R199 001 703	2	18	2 ± 0.1
	R199 001 713		18.6	2.4 ± 0.2

NOTE:

- (1) Kits including housing and inserts are available. Please consult sales.
- (2) Other length and PCB thickness available upon request: please consult sales.

## Cable Assembly

Each cable assembly consists of:

- One housing
- One cover
- One latch
- One or several inserts corresponding to customer's configuration

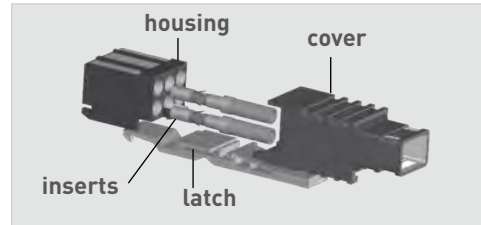

## HOUSING (two types of housing for straight female cable assembly kit are offered)

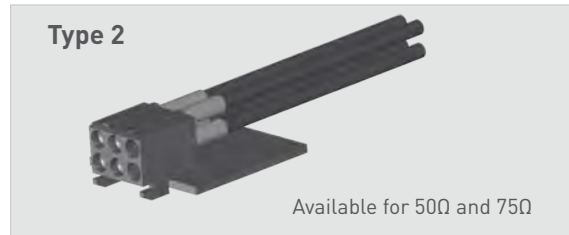
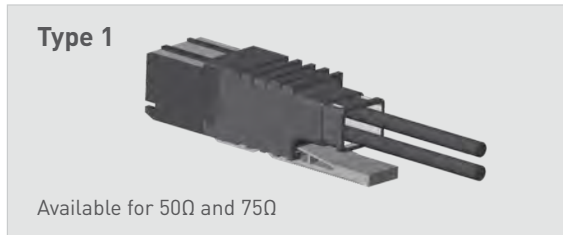

### Type 1: HOUSING FOR FEMALE INSERTS

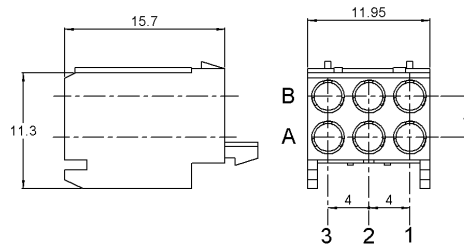

Part number
R694 262 056

Straight inserts (see page 5-14)  
for 50Ω: **R199 001 003** or **R199 001 023**  
for 75Ω: **R199 001 053**

### Type 2: HOUSING FOR FEMALE INSERTS WITH PRESS-IN FIXING STUD (for panel and PCB mounting)

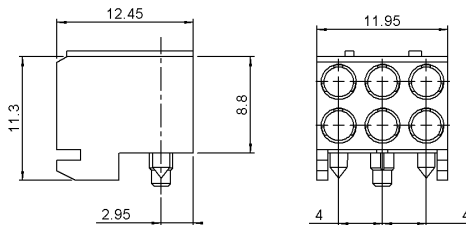

Part number
R694 262 906

Straight inserts (see page 5-14)  
for 50Ω: **R199 001 003** or **R199 001 023**  
for 75Ω: **R199 001 053**

### COVER (type 1 only)

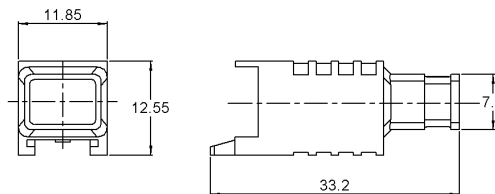

Part number
R280 420 010



Cable Assembly

LATCH (type 1 only)

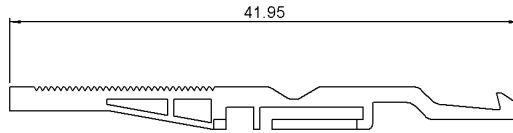
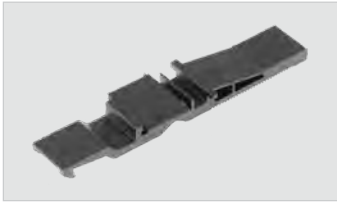

Part number
R280 420 030

KIT: COVER + FEMALE HOUSING + LATCH (type 1 only)

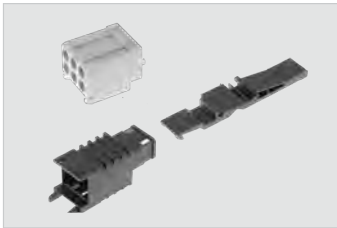

Part number	Composed of
R280 420 058	R694 262 056 + R280 420 010 + R280 420 030

STRAIGHT FEMALE REMOVABLE INSERTS, FULL CRIMP TYPE (type 1 and 2)

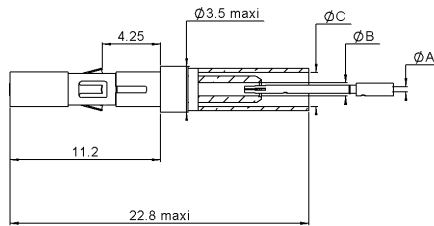

Impedance	Cable group	Cable group dia.	Part number	Dimensions (mm)			Extraction procedure	Packaging
				A	B	C		
50Ω	RG178	2/50/S	R199 001 003	0.4	1	2.55	U02	100 pieces
	RG174	2.6/50/S	R199 001 023	0.6	1.7	2.92		
75Ω	-	2.5/75/D	R199 001 053	0.4	1.2	2.95		

COMPLETE CABLE ASSEMBLY KIT (non assembled)

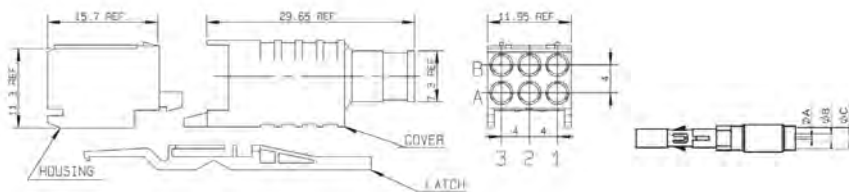
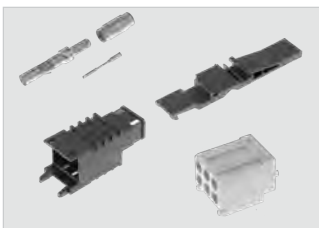

include housing + latch+ 6 contacts + cover (cable not included)

Impedance	Cable group	Cable group dia.	Part number	Position	Dimensions (mm)			Extraction procedure	Packaging
					A	B	C		
50Ω	RG178	2/50/S	R694 252 507		0.4	1	2.55	U02	30 pieces
	RG174	2.6/50/S	R694 252 537		0.6	1.7	2.92		
75Ω	-	2.5/75/D	R694 252 557		0.4	1.2	2.95		

## Samples and Guide Pins

### SAMPLE PIGTAIL



Part number	Position	Designation	Note
R284 906 002		20 cm pigtail	Can be used with demonstration board R299 400 020

### STANDARD SAMPLE CABLE ASSEMBLY



Part number	Position	Designation
R284C0431006		Coaxipack cable assembly 15 cm

### STANDARD SAMPLE CABLE ASSEMBLY (equipped with female coaxial inserts)

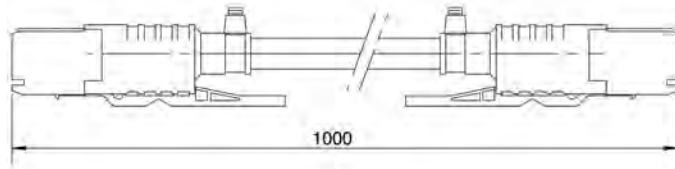

Cable group	Cable group dia.	Part number	Extraction procedure
RG 174	2.6/50/S	R285 930 005	U02

Special configuration is available upon request. Please consult sales.

### GUIDE PINS

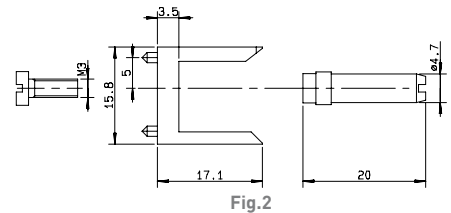
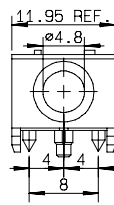
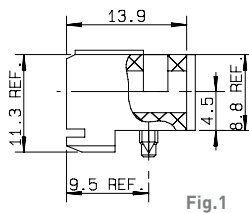

Part number	Fig.	Designation
R280 420 300	1	Female housing for guide pin
R280 420 200	2	Kit = Male housing + guide pin + screw

(1) Other guide pin length available upon request. Please consult sales.

Extraction Procedures

U01 HOW TO USE TOOL R282 920 010

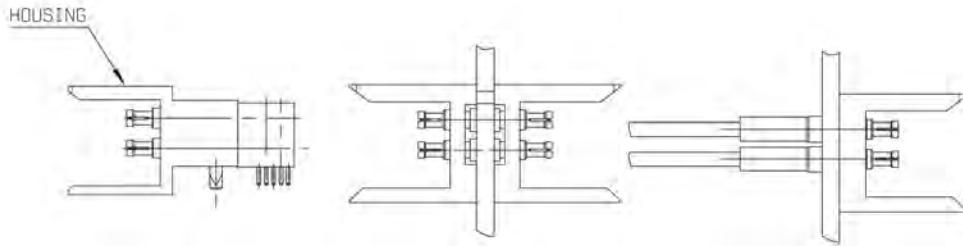

Inserts	Pre-assembled modules	
R199 001 203	R694 251 111	R694 251 115
R199 001 223	R694 251 112	R694 251 116
R199 001 733	R694 251 113	R694 251 117
	R694 251 114	

- Place the extraction tool as shown (upper coaxial contact only for twin coax) and push in axial direction into the housing until it stops.

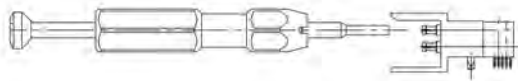

- Then press gently on the rod to remove the contact from the rear of the housing.

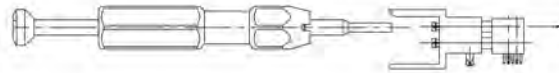

U02 HOW TO USE TOOL R282 920 100

Kits	Inserts
R285 930 005	R199 001 003
R694 252 507	R199 001 023
R694 252 537	R199 001 053
R694 252 557	

- Use a screw-driver to remove the cover from the housing as shown.

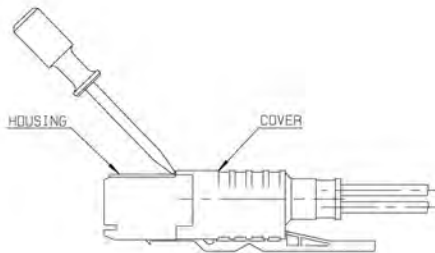

- Slide the cover along the cable.

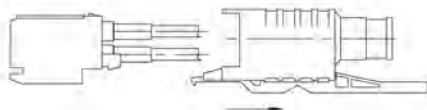

- Place the extraction tool (as shown) and push in axial direction into the housing until it stops.

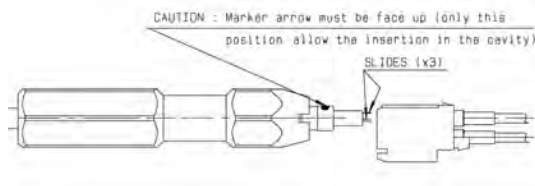

- Then press gently on the piston to remove the contact from the rear of the housing.

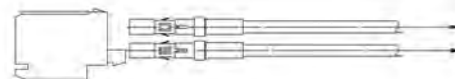

# NOTE





## SWITCHING CONNECTORS/MOEBIUS MC-CARD/RP-MCX

*R199/R299*

**Contents**

Introduction .....	5-4 to 5-5
<b>MOEBIUS</b>	
Characteristics .....	5-6
Receptacles .....	5-7
Switching connectors .....	5-7
Plugs .....	5-8
Adapters .....	5-8
PCB pattern .....	5-8
<b>MC-CARD</b>	
Characteristics .....	5-9
Plugs .....	5-10
SMT Receptacle .....	5-10
SMT Switches .....	5-11
Adapters .....	5-11
Assembly instructions .....	5-12
PCB pattern .....	5-12
<b>RP-MCX</b>	
Interface .....	5-13
SMT Switches .....	5-13
<b>RF POWER SWITCHING CONNECTORS</b>	
QMA Type .....	5-14
N Type .....	5-15
SMA Type .....	5-14
QN Type .....	5-15
TNC Type .....	5-14

## Introduction

Radiall offers a complete range of switching connectors that consists of four families:

- Microminiature, Moebius, for high life cycle mobile applications
- Microminiature, MC-Card, for mobile applications
- Reverse polarity MCX
- Power, for infrastructure applications



### Microminiature Moebius: Designed for Life

We chose Moebius in reference to the Möbius strip, as the origin of the infinity symbol. It is a good illustration for the very high durability performance of the Moebius connector. The Moebius interface is designed to be used as an antenna connection for handheld and mobile computing devices. The switching connector provides high RF performance and it is extremely durable and reliable as a snap-on connection.

### Microminiature MC-Card

The MC-Card series are micro miniature, 50 $\Omega$  connectors that feature snap-on mating and a frequency range of  $\sim$ 8 GHz. The MC-Card series was designed by Radiall in the 90s. With the success of the switching version, it made the MC-Card an excellent alternative to MMCX connectors for numerous wireless and telecom applications. In addition, the MC-Card series offers similar performance as the MMCX by featuring quick snap-on mating and unmating withstanding a minimum of 5,000 mating cycles.

The globally adopted switching connector version consists of a female edge card receptacle with an integrated switch for SMT assembly. It allows for automatic switching between two RF signal paths. This connector is mainly used for wireless PCMCIA-Cards or GPS devices to switch between the internal antenna and a higher-gain external antenna.

In addition to the standard MC-Card series, Radiall also offers a 3mm dia. MC-Card. With this version, wireless equipment can be differentiated and protected against wrong antenna connections.





## Introduction

### Reverse Polarity MCX

This switching connector is available in straight SMT version and can be placed anywhere on the PCB. Reverse polarity MCX connectors must be used to activate the switch function. It is not compatible with standard MCX.

### Power Switching Connectors

RF power switching connectors are surface/edge mountable. It's a two in one solution replacing the existing standard RF switches by integrating the switch function into a connector. This solution provides a unique means of switching between two RF signal paths. The switch is mechanically activated by mating and unmating the connector.

### MAIN ADVANTAGES

- Reliable
- Increases the density
- Excellent electrical and mechanical performance
- Cost savings
- Available in a right or left version
- Many interfaces available: N, TNC, SMA, QN, QMA and more

### MAIN APPLICATIONS

- Telecom base station equipment
- RF power amplifiers

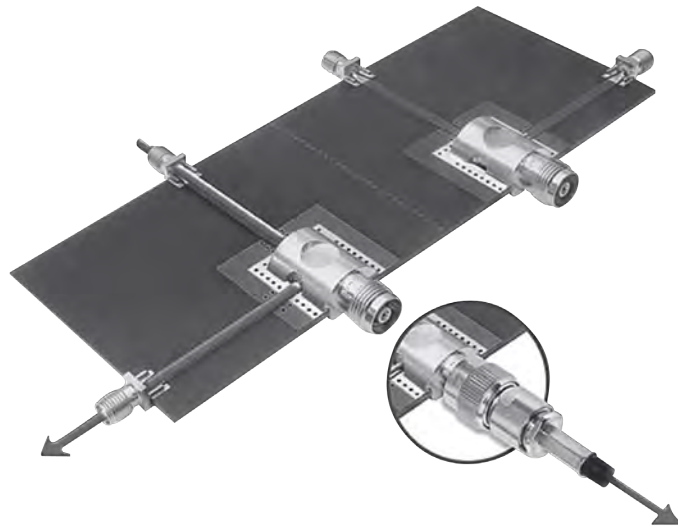

## Characteristics

	Not mated	Mated
Operating temperature range	-40°C to + 110°C	
Rated power	10 W / 900 MHz	
DC Current Withstanding	1 A max	
Frequency range	DC to 6 GHz	
V.S.W.R.	1.20 max DC to 3 GHz 1.50 max 3 to 6 GHz	1.15 max DC to 3 GHz 1.25 max 3 GHz to 6 GHz
Insertion loss	0.15 dB max DC to 2 GHz 0.20 dB max 2 GHz to 3 GHz 0.40 dB max 3 GHz to 6 GHz	0.10 dB max DC to 2 GHz 0.15 dB max 2 GHz to 3 GHz 0.20 dB max 3 GHz to 6 GHz
Isolation loss	- - -	35 dB minDC to 1 GHz 25 dB min 1 GHz to 3 GHz 25 dB min 3 GHz to 6 GHz

Item	Specification	Conditions
Contact resistance	200 mΩ max	100 mA
Insulation resistance	3000 MΩ min	250 V DC
Withstanding voltage	No flashover or insulation breakdown	250 V rms
Vibration	No discontinuities > 1μs under 100mA	Sinus: 5-500Hz / displacement 0.75 peak / acceleration 10 g duration 2h in each direction Random: 5-1000Hz / displacement 0.75 peak / acceleration 3.3 g duration 1h in each direction 25 dB min 3 GHz to 6 GHz
Shock	No discontinuities > 1μs under 100mA	Acceleration 50 g / duration pulse 11 ms / waveform pulse half sinus / number of shocks 3 per direction
Free fall	Center contact resistance RF measurements No discontinuities > 1 ms under 100mA	NFC 20732 method 1 Test area concrete / fall height 1 m / duration 2*2 falls
Temperature life	Center contact resistance RF measurements	T + 90°C / duration 1000 h / 40% HR
Thermal shock	Center contact resistance RF measurements	T - 40°C to + 90°C Exposure 15mn / transfert time < 10 s / 100 cycles
Damp heat	Center contact resistance RF measurements	40°C / 93% / 21 days
Retention Force • Insertion Force - mating • Extraction Force - unmating	9N 12N	Initial
Durability	Mating - unmating force Center contact resistance RF measurements	25.000 cycles

## MATERIALS AND PLATING

	Material	Plating
Body	Brass	NPGR
Center contact		
Outer contact		
Insulator	PTFE / nc	
Others parts	Beryllium copper	NPGR

Receptacle and Switching Connector

RECEPTACLE

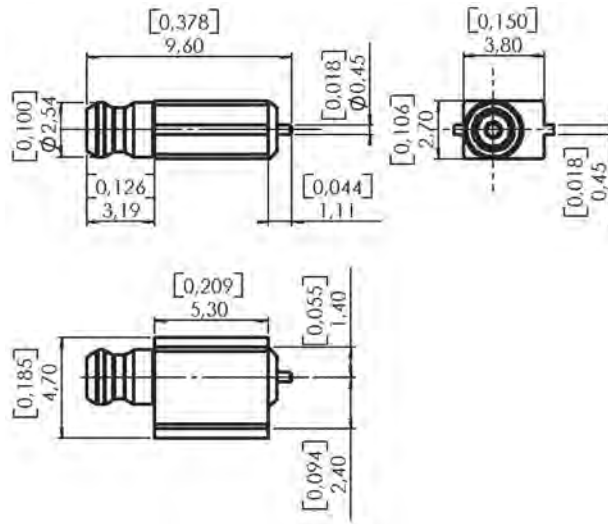

Part number	Packaging	RoHS
R199 006 413	100 pieces/reel	Yes

SWITCHING CONNECTOR

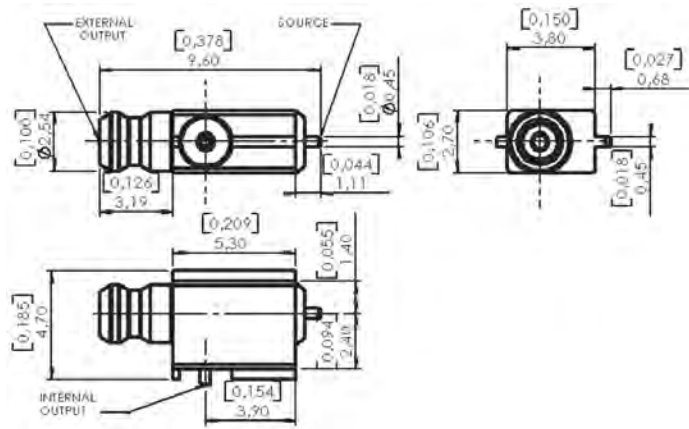

Part number	Packaging	RoHS
R199 006 813	100 pieces/reel	Yes

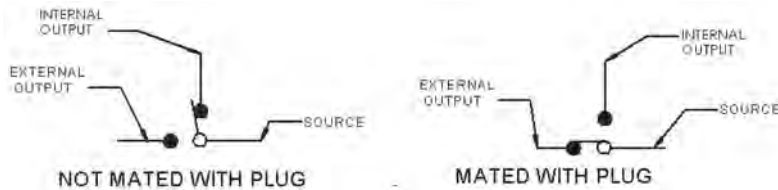

## Plugs, Adapter and PCB Pattern

### STRAIGHT AND RIGHT ANGLE PLUGS

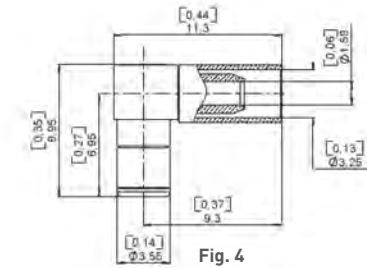
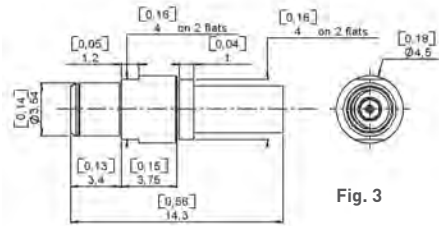
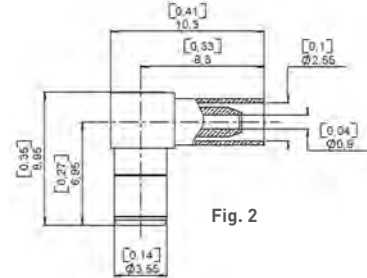
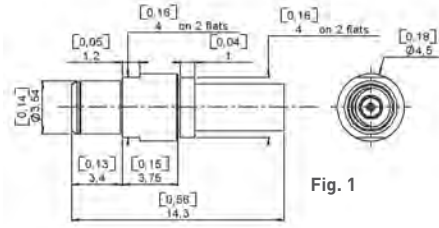

Cable group	Cable group dia.	Part number	Fig.	Packaging	RoHS
RG178 / RG196	2/50/S	R199 006 203	1	100/box	Yes
		R199 006 213	2		
RG174 / RG316	2.6/50/S	R199 006 263	3		
		R199 006 273	4		

### SMA ADAPTER

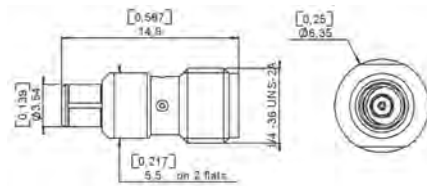

Part number	Packaging	RoHS
R191 857 000	Unit	Yes

### PCB Pattern

#### P01

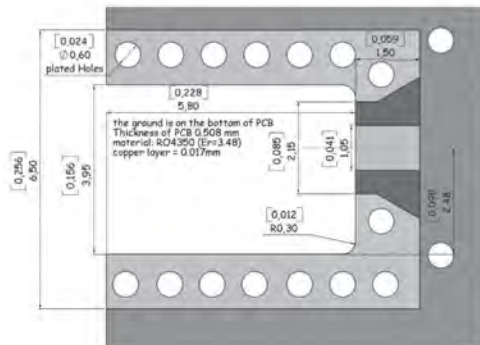

Receptacles

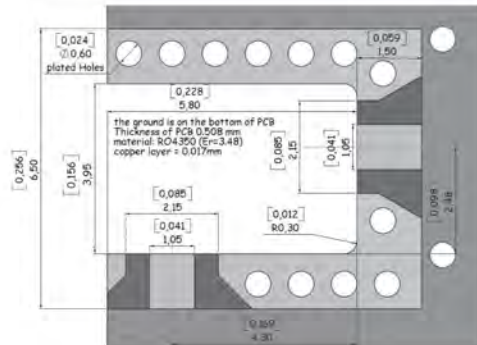

Switching Connectors

## Characteristics

Test / Characteristics	Values / Remarks
------------------------	------------------

**ELECTRICAL CHARACTERISTICS**

Impedance	50Ω				
Frequency range	Connectors: DC - 8 GHz Switch: DC - 3 GHz				
Typical V.S.W.R. • Straight models - 2/50 cable • Right angle models - 2/50 cable - 2.6/50 cable	1	2.5	4	6	8
	1.07	1.15	1.16	1.17	1.25
	1.08 1.05	1.17 1.08	1.22 1.10	1.26 1.13	1.30 1.12
Insertion loss (dB) • Straight connectors • Right angle connectors	0.04	0.08	0.11	0.15	0.15
	0.05	0.10	0.15	0.20	0.25
RF leakage (dB max)	-65 dB max at 8 GHz				
Insulation resistance	5000 MΩ min				
Contact resistance • Center contact • Outer contact	1.5 mΩ				
	0.2 mΩ				
Working voltage in V.R.M.S. • At sea level (at 21000 m)	170				
Dielectric withstanding voltage in V.R.M.S. • At sea level	500				
RF testing voltage sea level in V.R.M.S.	500				

**MECHANICAL CHARACTERISTICS**

Durability	5000 matings
Force to engage and disengage	6.2 N
Force to disengage	8.8 N
Cable retention force • 2/50 cable • 2.6/50 cable	58 N
	110 N
Center contact retention force	slide-on

**ENVIRONMENTAL CHARACTERISTICS**

Temperature range • Switches • Others	-40°C / +110°C
	-25°C / +125°C
Thermal cycling test	MIL STD 202, method 107, condition B
High temperature endurance	MIL STD 202, method 108
Corrosion (salt spray)	MIL STD 202, method 101, condition B
Vibration	MIL STD 202, method 204, condition B
Shock	MIL STD 202, method 213, condition G
Moisture resistance	MIL STD 202, method 106
Hermeticity	MIL STD 202, method 112, condition C
	Vacuum 10 <sup>-6</sup> Hgmm (Torr)
	Leakage rate 10 <sup>-6</sup> atm / cm <sup>3</sup> / s
Barometric pressure	Pressure test: 3.5 bars; duration: 2 mn; Temperature: 15°C to 25 °C

**MATERIALS**

Bodies	Brass
Center contact • Male • Female	Brass
	Bronze or heat treated Beryllium following QQ-C-530
Insulator • Cable connectors • Switches	PTFE
	Polyether ethercetone 30% GF
Gasket	Silicon rubber

**PLATING**

Bodies • Cable connectors • SMT receptacles • Edge card receptacles • Switches	Nickel or BBR
	Gold
	Gold
	Gold
	Gold
Center contacts	Gold

## Plugs and SMT Receptacle

### STRAIGHT PLUGS

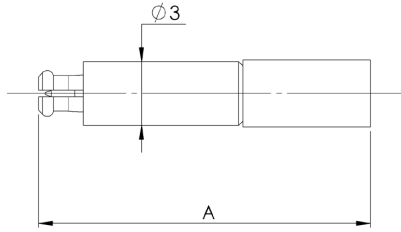

Cable group	Cable group dia.	Part number	Dimensions A (mm)	Captive center contact	Finish	Note
RG178 / RG196	2/50/S	R199 005 200	15.6	No	Nickel	Crimp type
RG405	.085"	R199 005 223	10.1	Yes	Gold	Solder type

### RIGHT ANGLE PLUGS

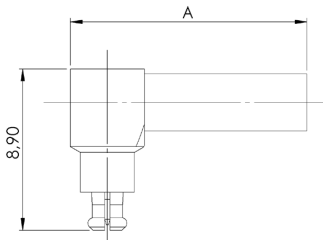

Cable group	Cable group dia.	Part number	Dimensions A (mm)	Captive center contact	Finish	Note
-	1/50/S	R199 005 310*	9.1	Yes	Gold	MC-CARD 3mm dia.
RG178 / RG196	2/50/S	R199 005 240	13.1		Nickel	Crimp type
RG174 / RG316	2.6/50/S	R199 005 250	7.8		Gold	Solder type
RG405	.085"	R199 005 273				

\*Specific 3 mm interface = not compatible with standard interface plug

### SMT RECEPTACLE

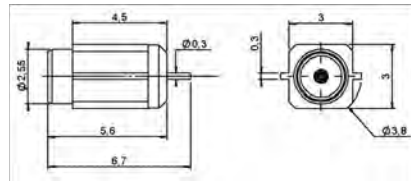

Fig. 1

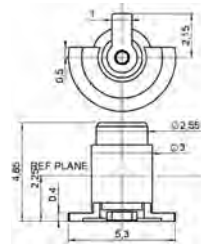

Fig. 2

Part number	Fig.	Captive center contact	Assembly instructions	PCB pattern	Finish	Packaging
R199 005 800	1	Yes	M01	P02	Gold	400 pieces/reel
R199 005 820	2		-	-		100 piece/reel

SMT Switches and Adapters

SMT SWITCHES

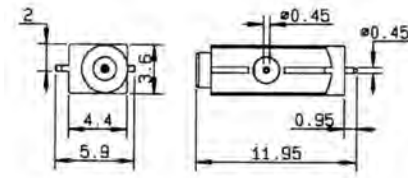

Fig. 1

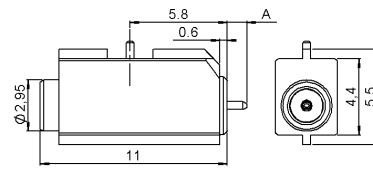

Fig. 2

Part number	Fig	Dimension A (mm)	Captive center contact	Assembly instructions	PCB pattern	Finish	Packaging	Note
R199 005 890	1		Yes	M01	P01	Gold	500 pieces/reel	-
R299 794 800*	2	0.93						MC-CARD 3mm dia.

\*Specific 3 mm interface = not compatible with standard interface plug

Electrical diagram on "M01"

BETWEEN SERIES ADAPTERS

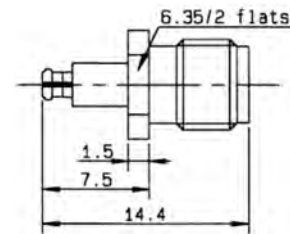

Fig. 1

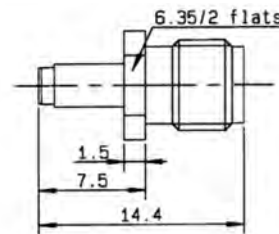

Fig. 2

Part number	Fig.	Series	Body and finish
R191 366 071	1	SMA female / MC CARD male	Passivated stainless steel
R191 366 091	2	SMA female / MC CARD female	



## Assembly Instructions

### M01

#### ELECTRICAL DIAGRAM

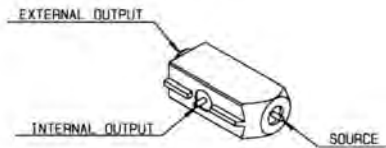

Part number	Step 1	Step 2
R199 005 890 R299 794 800	<p>UNMATED CONNECTOR</p>	<p>MATED WITH MC CARD PLUG</p>

## VIDEO SHADOW AND ASPIRATION AREA

Part number	Video shadow of receptacle	Aspiration area
R199 005 800		
R199 005 890 R299 794 800		

\*2.95 for: R299 795 830 - R299 794 800

## PCB Pattern

### P01

Part number

R199 005 890  
R299 794 800

### P02

Part number

R199 005 800

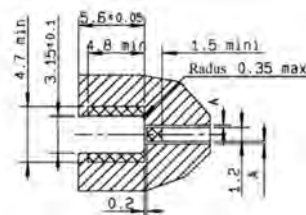
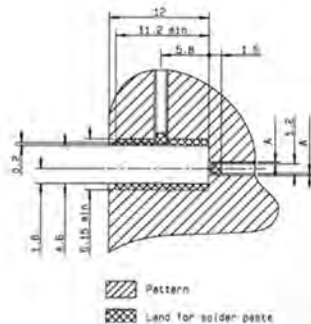

PCB thickness (mm)	Coplanar line A (mm)
0.8	0.183
1.0	0.190
1.2	0.195
1.6	0.200

Interface

PLUG

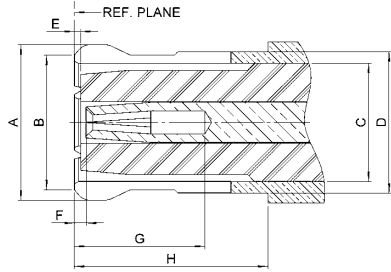

JACK

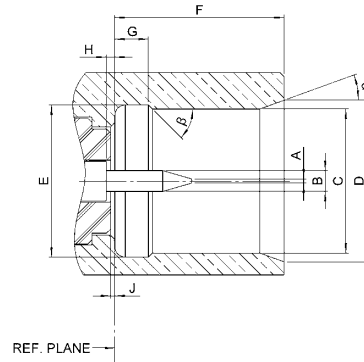

Letter	mm		inch	
	min.	max.	min.	max.
A DIA	-	3.80	-	.150
B DIA	-	3.60	-	.142
C DIA	-	3.00	-	.118
D DIA	-	3.40	-	.134
E	0	-	0	.004
F	0	-	0	.008
G	2.60	-	.110	-
H	4.15	-	.163	-

Letter	mm		inch	
	min.	max.	min.	max.
A DIA	3.15	3.20	.124	.126
B DIA	2.74	2.84	.108	.112
C DIA	0.52	0.60	.0205	.0235
D DIA	0	-	0	-
E DIA	1.14	1.40	.045	.055
F	0.36	0.41	.014	.016
G	3.53	3.68	.139	.145
H			0	
J			0	
A	18°	22°	18°	22°
B	43°	47°	43°	47°

SMT Switches

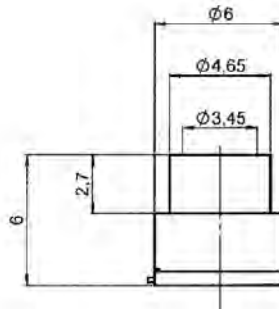
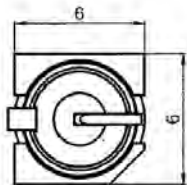

Part number	Finish	Packaging
R299 137 800	Gold	Tape & Reel 200 pieces
R299 137 801		Tape & Reel 900 pieces

## RF Power Switching Connectors

Test / Characteristics	Values / Remarks				
------------------------	------------------	--	--	--	--

### ELECTRICAL CHARACTERISTICS

	QMA	QN	SMA	N	TNC
Impedance	50Ω				
Frequency range	DC - 3 GHz				
Typical V.S.W.R.	$1.1 + 0.1000 \times F$ (GHz) Maxi	$1.1 + 0.1000 \times F$ (GHz) Maxi	$1.1 + 0.1000 \times F$ (GHz) Maxi	$1.1 + 0.1000 \times F$ (GHz) Maxi	
Isolation at <ul style="list-style-type: none"> <li>DC to 1 GHz</li> <li>1 to 2 GHz</li> <li>2 to 3 GHz</li> </ul>	- 47 dB typical - 43 dB typical - 40 dB typical				
Insertion Loss at <ul style="list-style-type: none"> <li>DC to 1 GHz</li> <li>1 to 2 GHz</li> <li>2 to 3 GHz</li> </ul>	- 0.1 dB maxi - 0.15 dB maxi - 0.2 dB maxi				
RF leakage	N/A				-
Voltage rating	300 Veff maxi				
Dielectric withstanding voltage	500 Veff mini				-
Insulation resistance	5000 MΩ mini				-
Power withstanding	110 W (at 2 GHz)	110 W (at 2 GHz)	50 W (at 1.8 GHz)	100 W (at 1.8 GHz)	50 W (at 1.9 GHz)

#### QMA TYPE

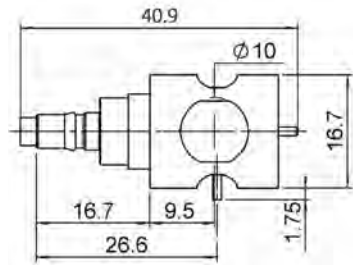

Part number	Type
R123 422 801	Right

#### SMA TYPE

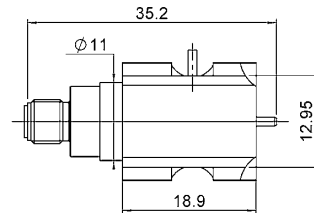

Part number	Type
R124 422 001	Right

#### TNC TYPE

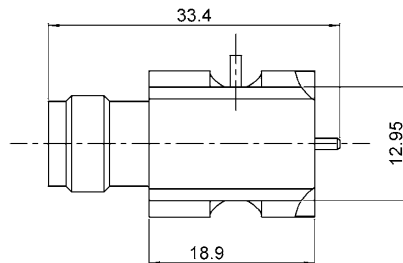

Part number	Type
R143 422 947	Left
R143 422 957	Right

RF Power Switching Connectors

Test / Characteristics	Values / Remarks
------------------------	------------------

**N TYPE**

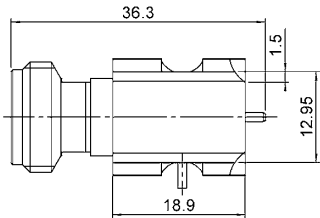

Part number	Type
R161 428 223	Left
R161 428 233	Right

**QN TYPE**

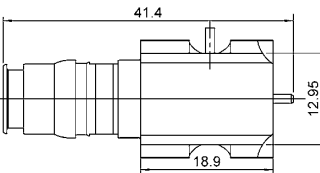

Part number	Type
R164 428 823	Left
R164 428 833	Right

RF POWER SWITCHING CONNECTORS

# NOTE





## SMB/SMB-LOCK/SMC

R114/R117/R112

**Contents****SMB**

Introduction .....	6-4 to 6-5
Interface .....	6-6
Characteristics .....	6-7 to 6-8
Plugs .....	6-8 to 6-11
Jacks .....	6-10 to 6-12
Bulkhead jacks .....	6-12 to 6-14
Receptacles .....	6-14 to 6-15
PCB receptacles .....	6-15 to 6-16
Adapters .....	6-17
Panel drilling .....	6-22
Assembly instructions .....	6-22

**SMB-LOCK**

Introduction .....	6-18
Interface .....	6-18
Characteristics .....	6-19
Plugs .....	6-20

**SMB LIMITED DETENT (SMB-A)**

Receptacles .....	6-21
-------------------	------

**SMB SLIDE-ON (SUBGLIS)**

Plugs and receptacles .....	6-21
-----------------------------	------

**SMC**

Introduction .....	6-23
Interface .....	6-23
Characteristics .....	6-24
Plugs .....	6-25
Jacks .....	6-25 to 6-27
Receptacles .....	6-27 to 6-28
Adapters .....	6-28
Panel drilling .....	6-28



Introduction

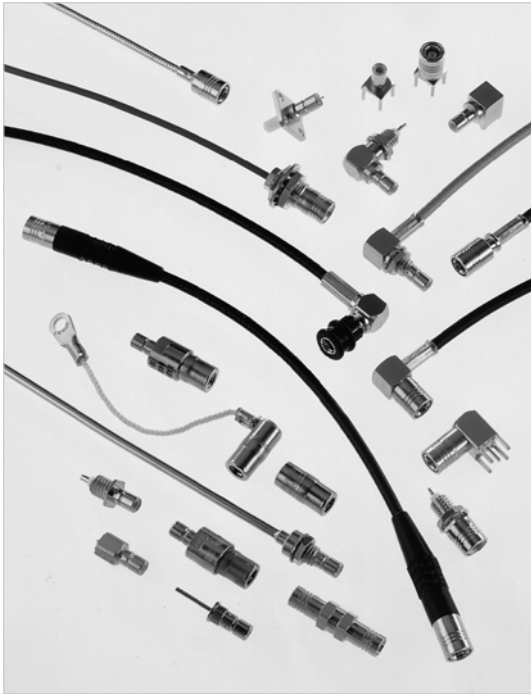

50Ω	DC - 4 GHz
-----	------------

**GENERAL**

- Subminiature coaxial connectors
- Snap-on coupling
- Plugs have female contacts
- Jacks have male contacts
- Low weight and reduced outline dimensions
- Captive contact (except contrary specification)

**APPLICABLE STANDARDS**

- SMB series MIL-C-39012  
MIL-C-39012/67-72
- IEC 169-10
- CECC 22130
- BS 9210 N0007

**APPLICATIONS**

- Mobile communication systems
- Civil and military telecommunications
- Aeronautics
- Automotive

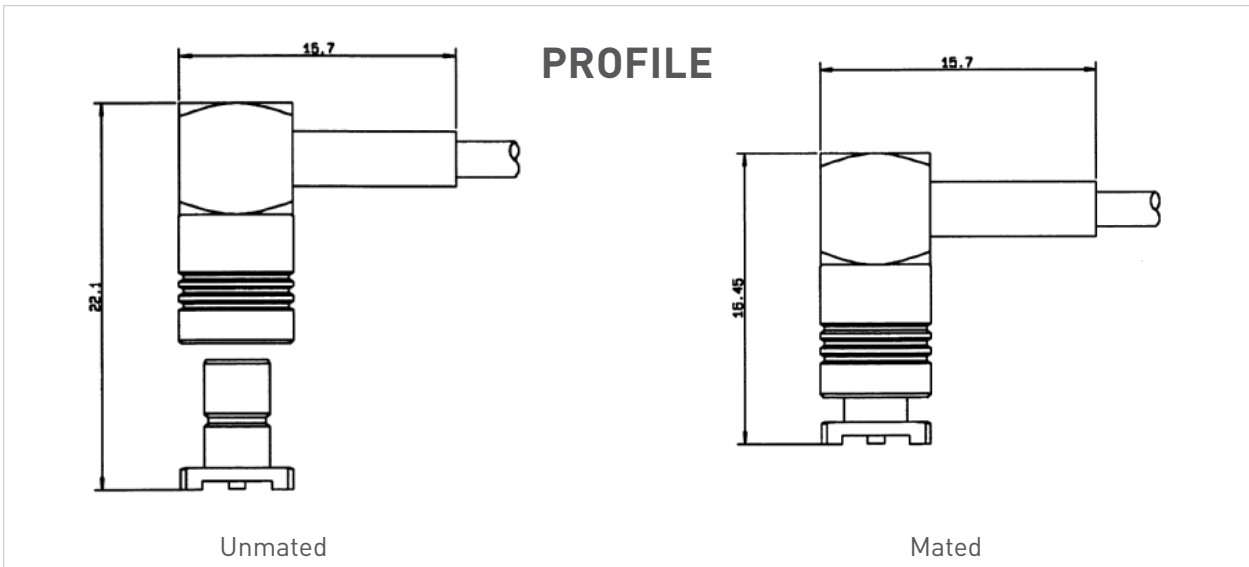

## Introduction

SMB snap-on subminiature coaxial connectors provide a fast and reliable connection for high density packaging for applications up to 4 GHz.

Radiall offers a very large range of SMB connectors, including cable plugs and jacks with bulkhead and panel mount configurations, bulkhead and panel mount receptacles; through hole, SMT and edge card receptacles and in-series and between series adapters.

SMB series also features versions with lower mating forces than standard. Four types of interconnection mechanisms are available:

- **SMB: Standard** snap-on connection  
The design permits quick engagement and disengagement.
- **SMB limited detent (SMB-A):** Snap-on connection with **low mating force**  
The design permits quick engagement and disengagement, and is suitable for printed circuit boards. Radiall offers a range of PCB and bulkhead receptacles with female center contact. The SMB-A receptacles are completely intermateable with standard SMB jacks.
- **SMB slide-on (SUBGLIS):** Slide-on connection  
The design is suitable for back plane and blind mate applications. In this case, we recommend the association of a mobile connector (floating jack / receptacle) with a fixed connector (panel plug / jack, receptacle). The SUBGLIS connectors are completely intermateable with standard SMB and SMB-A connectors and for that, they can be used for test applications.
- **SMB Lock:**  
Plugs (with female center contact) have a coupling nut allowing a reliable lock-on connection (50 N min). This range allows a visual control of the locking system.

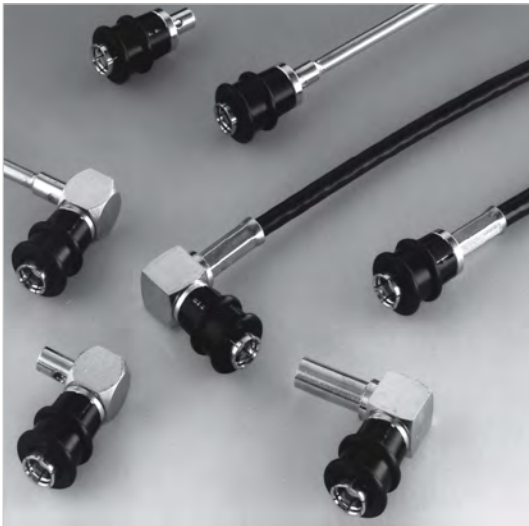

These four types of SMB connectors have the same electrical performance.

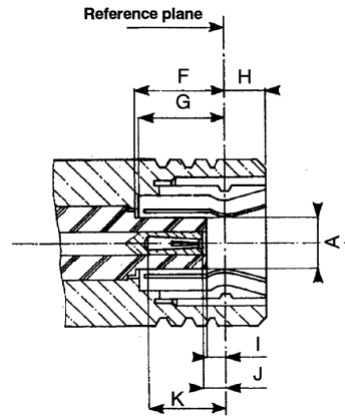
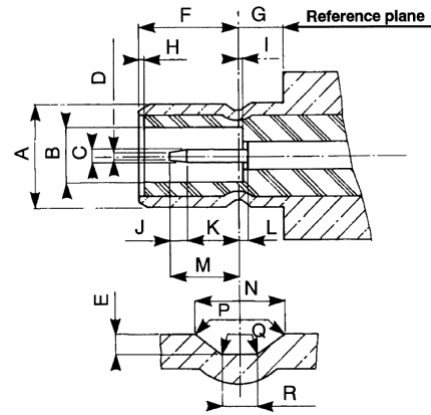
**PLUG** (with female contact)**JACK** (with male contact)

Letter	mm		inch	
	min.	max.	min.	max.
A DIA	-	2.06	-	.081
F	3.58	-	.141	-
G	3.58	-	.141	-
H	-	1.63	-	.064
I	0.18	-	.007	-
J	0.18	0.94	.007	.037
K	2.97	-	.117	-

Letter	mm		inch	
	min.	max.	min.	max.
A DIA	-	3.71	-	.146
B DIA	2.08	-	.082	-
C DIA	0.48	0.53	.019	.021
D DIA	-	0.25	-	.010
E	0.15	0.25	.006	.010
F	3.33	3.58	.131	.141
G	1.65	-	.065	-
I	-	0.18	-	.007
J	0.25	-	.010	-
K	1.32	-	.052	-
L	-	0.18	-	.007
M	-	2.97	-	.117
N	0.69	0.94	.027	.037
P	0.05	0.15	.002	.006
Q	-	0.13	-	.005
R	0.28	0.38	.011	.015

CLAMP TYPE CONNECTORS: R 114 xxx 000 = braid retention with cylindrical gasket

R 114 xxx 133 = braid retention with V groove gasket

## Characteristics

Test / Characteristics	MIL-C-39012 A	Values / Remarks
------------------------	---------------	------------------

## ELECTRICAL CHARACTERISTICS

Impedance		-	50Ω				
Frequency range		-	DC - 4 GHz				
V.S.W.R. (typ.) • Straight models	cable group: Frequency	3-14	1 GHz	2.5 GHz	4 GHz		
		2	1.12	1.22	1.33		
	• Right angle models	.085"	-	1.10	1.22	1.33	
			2	1.12	1.22	1.35	
		.085"	-	1.10	1.18	1.26	
			2	1.10	1.20	1.25	
Insertion loss (typ.) dB • Straight models	cable group: Frequency	3-27	0.05	0.07	0.15		
		2	0.05	0.10	0.25		
	• Right angle models	.085"	-	0.05	0.05	0.05	
			2	0.05	0.07	0.12	
		RF leakage		3-26	-55 dB min from 2 to 3 GHz		
		Insulation resistance		3-11	1000 MΩ min		
Contact resistance		3-16	Initial	After test			
• Center contact (mΩ)		-	6	8			
• Outer contact (mΩ)		-	1	1.5			
Working voltage		-	2/50	2.6/50			
• Cable group		-	250 V rms	335 V rms			
• At sea level		-	60 V rms	85 V rms			
• At 70000 ft (21000 m)		-					
Dielectric withstanding voltage		3-17	2/50	2.6/50			
• Cable group		-	750 V rms	1000 V rms			
• At sea level		-	185 V rms	250 V rms			
• At 70000 ft (21000 m)		-					
RF withstanding voltage (5 MHz sine wave)		3-23	2/50	2.6/50			
• Cable group		-	500 V rms	700 V rms			
• At sea level		-					

## MECHANICAL CHARACTERISTICS

Durability	3-15	500 matings
Mating / Unmating	3-5-1	Axial force: 62 N max (14 Lbf)
Cabling retention force	cable group: • 2/50 • 2.6/50	3-24 58 N (13Lbf) 110 N (25Lbf)
Center contact retention	-	Axial: 10 N (2.25 Lbf)

## ENVIRONMENTAL CHARACTERISTICS

Temperature range	-	-65°C / + 165°C
• Standard models	-	-65°C / +165°C
• Hermetic sealed models	-	-65°C / +105°C
• Models for semi-rigid cables	-	
Combined climate tests		MIL-STD-202, method 102, condition C
Thermal shock	3-20	MIL-STD-202, method 107, condition B
High temperature endurance		MIL-STD-202, method 108
Corrosion (salt spray)	3-13	MIL-STD-202, method 101, condition B, 5%
Vibrations	3-18	MIL-STD-202, method 204, condition B, 15g
Shocks	3-19	MIL-STD-202, method 213, condition B, 75g
Low pressure	3-22	MIL-STD-202, method 105, condition C
Hermetic seal	-	Applied vacuum 10 <sup>-6</sup> mm of Hg (Torrs) Leakage rate < 10 <sup>-6</sup> atm/cm <sup>3</sup> /s

## MATERIALS AND PLATING

	Material	Plating
Body and center pin contact	Half hard brass as per QQ-B-626	Gold or nickel (Body)
Center socket contact	Beryllium copper as per QQ-C-530	Gold (Center contact)
Ferrules	Brass	-
Insulators	PTFE teflon	-
Gaskets	Silicone elastomer	-

Standard packaging: 100 pieces

All dimensions are given in mm.

Characteristics

POWER RATING

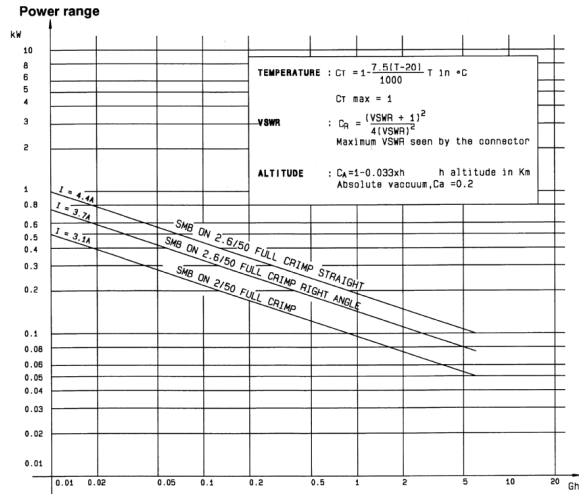

Plugs

STRAIGHT PLUGS CRIMP TYPE FOR FLEXIBLE CABLES

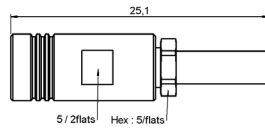

Fig. 1

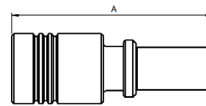

Fig. 2

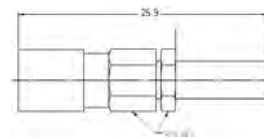

Fig. 3

Cable group	Cable group dia.	Part number	Fig.	Dimensions A (mm)	Captive center contact	Finish	Note
RG178 / RG196	2/50/S	R114 073 000	1	-	Yes	Gold	-
RG174 / RG316 / RG179	2.6/50+75/S	R114 075 000		-			
		R114 082 000	19.8	Full crimp			
RD316	2.6/50/D	R114 083 000	2				18.4
RG178 / RG196	2/50S	2002-1571-002	3	-		Nickel	-
		2002-7571-002		-			
RD178	2/50D	2002-1571-005		-			
		2002-7571-005		-			
RG174 / RG316	2.6/50S	2002-1571-003		-			
		2002-7571-003		-			
RD316	2.6/50D	2002-1571-019	-				
		2002-7571-019	-	Nickel	-		

Plugs and Jacks

**STRAIGHT PLUGS CLAMP TYPE FOR FLEXIBLE CABLES**

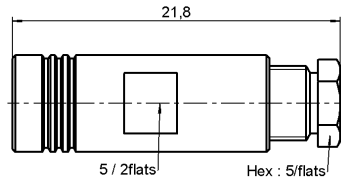

Fig. 1

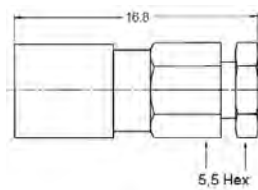

Fig. 2

Cable group	Cable group dia.	Part number (Gold)	Part number (Nickel)	Fig.	Captive center contact
RG178 / RG196	2/50/S	R114 003 000	N/A	1	Yes
RG174 / RG316 / RG179	2.6/50+75/S	R114 005 000			
RG178 / RG196	2/50S	2002-1551-002	2002-7551-002	2	
RD178	2/50D	2002-1551-005			
RG174 / RG316	2.6/50S	2002-7551-003	2002-7551-003		
RD316	2.6/50D	2002-7551-019	2002-7551-019		

**STRAIGHT PLUG FOR SEMI RIGID CABLES**

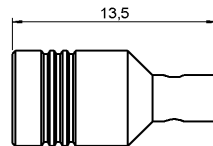

Fig. 1

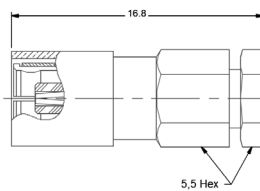

Fig. 2

Cable group	Cable group dia.	Part number (Gold)	Part number (Nickel)	Fig.	Captive center contact	Note
RG405	.085"	R114 053 000	-	1	No	Solder type
		2002-1541-010	2002-7541-010	2	Yes	Solder clamp
RG402	.141"	2002-1541-003	2002-7541-009			

Plugs and Jacks

RIGHT ANGLE PLUGS AND JACKS CRIMP TYPE FOR FLEXIBLE CABLES

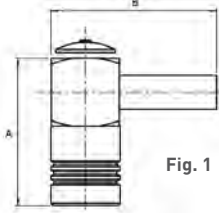

Fig. 1

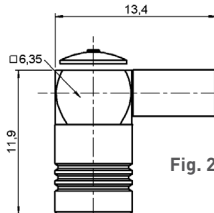

Fig. 2

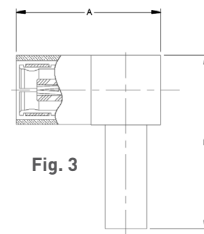

Fig. 3

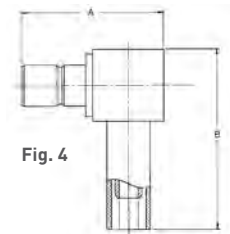

Fig. 4

Cable group	Cable group dia.	Part number (Gold)	Part number (Nickel)	Fig.	Dimensions mm		Captive center contact	Note
					A	B		
RG178 / RG196	2/50/S	R114 183 000		1	13.7	15.3	Yes	-
RG174 / RG316 / RG179	2.6/50+75/S	R114 185 000	N/A	2	-	-		Short version
		R114 186 000		1	13.7	15.3		-
		R114 186 100			15.1	15.4		Full crimp
		R114 187 000			13.7			-
RD316	2.6/50/D	R114 182 000						-
RG178 / RG196	2/50S	2105-1521-002	2105-7521-002	3	13.2	16		-
		2141-1521-002		4	12.7			-
RD178	2/50D	2105-1521-005	2105-7521-005	3	13.2			-
RG174 / RG316 / RG179	2.6/50S	2105-1521-003	2105-7521-003	3	13.2			-
		2141-1521-003	2141-7521-003	4	12.7		-	
RD316	2.6/50D	2105-1521-019	2105-7521-019	3	13.2		-	
		2141-1521-019	2141-7521-019	4	12.7		-	



Plugs and Jacks

**RIGHT ANGLE PLUGS AND JACKS CLAMP TYPE FOR FLEXIBLE CABLES**

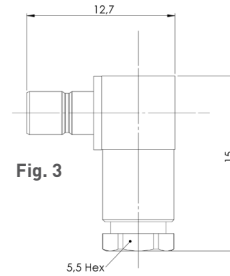
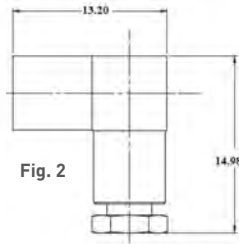
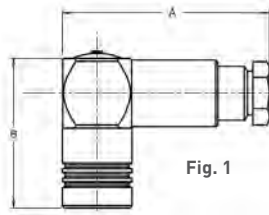

Cable group	Cable group dia.	Part number (Gold)	Part number (Nickel)	Fig.	Dimensions mm		Captive center contact
					A	B	
RG178 / RG196	2/50/S	R114 163 000	N/A	1	19	13.7	Yes
	2.2/50/D	R114 163 420			16.7		
RG174 / RG316 / RG179	2.6/50+75/S	R114 165 000			19		
RG178 / RG197	2/50S	2005-1551-002	2005-7551-002	2	-	-	
		2041-1551-002	-	3	-	-	
RG174 / RG316 / RG179	2.6/50S	2005-1551-003	2005-7551-003	2	-	-	
		2041-1551-003	2041-7551-003	3	-	-	
RD316	2.6/50D	2005-1551-019	-	2	-	-	

**RIGHT ANGLE PLUGS AND JACKS FOR SEMI RIGID CABLES**

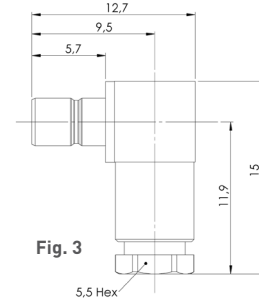
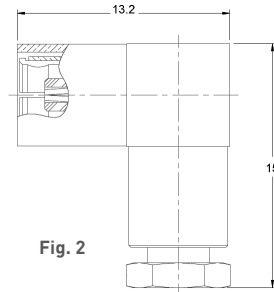
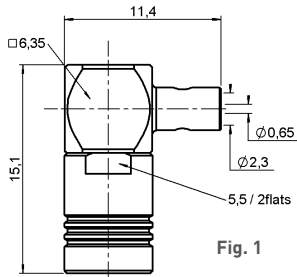

Cable group	Cable group dia.	Part number (Gold)	Part number (Nickel)	Fig.	Captive center contact	Note
RG405	.085"	R114 169 000	N/A	1	Yes	Cable bending required Solder type for semi rigid cable
		2005-1541-010	2005-7541-010	2		
		2041-1541-010	2041-7541-010	3		
RG402	.141"	2005-1541-009	2005-7541-009	2		Solder clamp
		2041-1541-009	-	3		

Jacks and Bulkhead Jacks

**STRAIGHT JACKS CRIMP TYPE FOR FLEXIBLE CABLES**

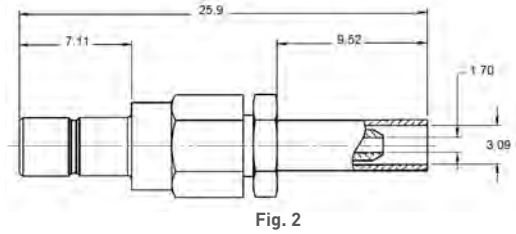
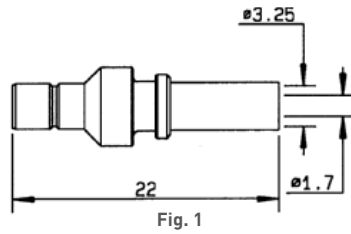

Cable group	Cable group dia.	Part number (Gold)	Part number (Nickel)	Fig.	Captive center contact	Note
RG174 / RG316 / RG179	2.6/50+75/S	R114 238 000	-	1	Yes	Full crimp
RG178 / RG197	2/50S	2001-1571-002	2001-7571-002	2		Crimp type
RD178	2/50D	2001-1571-005	-			
RG174 / RG316 / RG179	2.6/50S	2001-1571-003	2001-7571-003			
RD316	2.6/50D	2001-1571-019	2001-7571-019			

**STRAIGHT BULKHEAD JACKS CRIMP TYPE FOR FLEXIBLE CABLES**

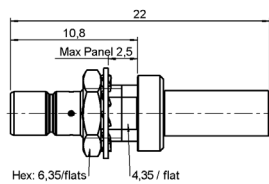

Fig. 1

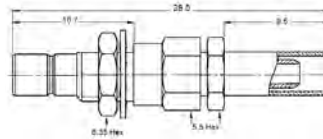

Fig. 2

Cable group	Cable group dia.	Part number (Gold)	Part number (Nickel)	Fig.	Captive center contact	Panel drilling	Note
RG174 / RG316 / RG179	2.6/50+75/S	R114 313 000	N/A	1	Yes	P08	Rear mount / Fill crimp
RG178 / RG197	2/50S	2003-1571-002	2003-7571-002	2			
RD178	2/50D	2003-1571-005	2003-7571-005				
RG174 / RG316 / RG179	2.6/50S	2003-1571-003	2003-7571-003				
RD316	2.6/50D	2003-1571-019	2003-7571-019				

Bulkhead Jacks

**STRAIGHT BULKHEAD JACKS CLAMP TYPE FOR FLEXIBLE CABLES**

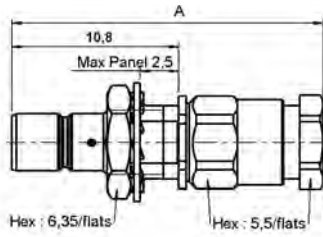

Fig. 1

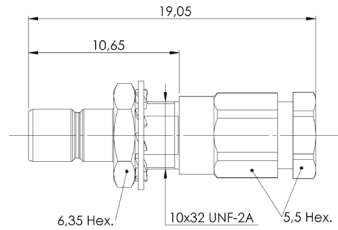

Fig. 2

Cable group	Cable group dia.	Part number (Gold)	Part number (Nickel)	Fig.	Dimensions A (mm)	Captive center contact	Panel drilling	Note
RG178 / RG196	2/50/S	R114 303 000	N/A	1	25.3	Yes	P08	Rear mount
		R114 303 133			20.1			
RG174 / RG316 / RG179	2.6/50+75/S	R114 305 000	25.3					
RG178 / RG197	2/50/S	2003-1551-002	2003-7551-002	2	-			
RD178	2/50/D	2003-1551-005	-		-			
RG174 / RG316 / RG179	2.6/50/S	2003-1551-003	2003-7551-003		-			
RD316	2.6/50/D	2003-1551-019	-		-			

**STRAIGHT BULKHEAD JACK SOLDER TYPE FOR SEMI-RIGID CABLE**

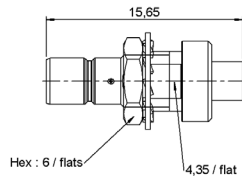
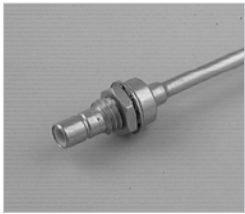

Fig. 1

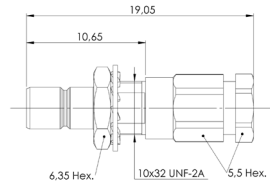
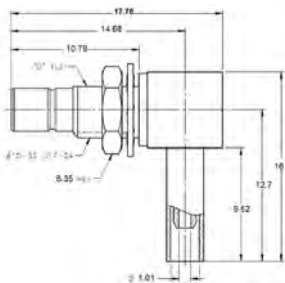

Fig. 2

Cable group	Cable group dia.	Part number (Gold)	Part number (Nickel)	Fig.	Captive center contact	Panel drilling	Note
RG405	.085"	R114 222 000	-	1	Yes	P08	-
		2003-1541-010	2003-7541-010	2			Solder clamp type
RG402	.141"	2003-1541-009	-				

**RIGHT ANGLE BULKHEAD CRIMP TYPE FOR FLEXIBLE CABLES**



Cable group	Cable group dia.	Part number (Gold)	Part number (Nickel)	Captive center contact	Panel drilling
RG178 / RG197	2/50S	2106-1521-002	2106-7521-002	Yes	P08
RD178	2/50D	2106-1521-005	-		
RG174 / RG316 / RG179	2.6/50/S	2106-1521-003	2106-7521-003		
RD316	2.6/50/D	2106-1521-019	2106-7521-019		

Receptacles

STRAIGHT FLANGE RECEPTACLES (male center contact)

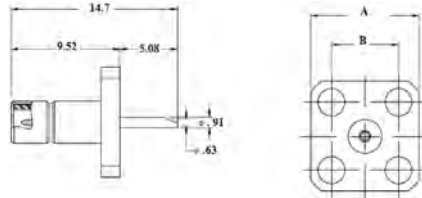
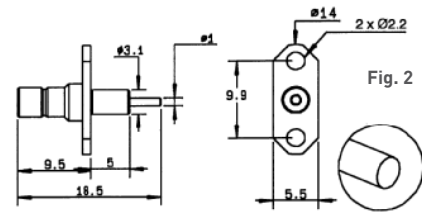
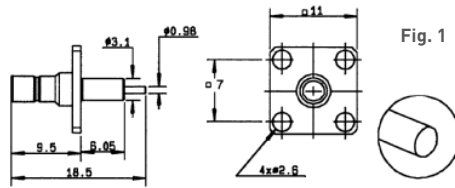
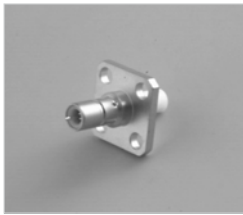

Fig. 3

Part number (Gold)	Part number (Nickel)	Fig.	Dimensions mm		Captive center contact	Panel drilling	Note
			A	B			
R114 413 000	N/A	1	-	-	No	P01	Square flange / Extended dielectric
R114 450 000		2	-	-		P06	2 hole glange / Extended dielectric / Unit packaging
2484-1511-000		3	9.5	5.9	Yes	-	2.36mm hole dia.
2486-1511-000	2486-7511-000	12.7	8.6	-			

STRAIGHT BULKHEAD RECEPTACLES (male center contact)

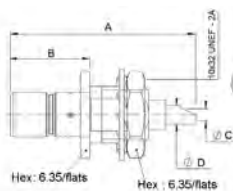

Fig. 1

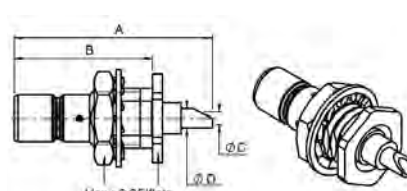

Fig. 2

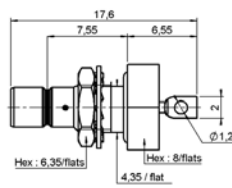

Fig. 3

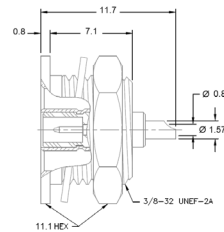
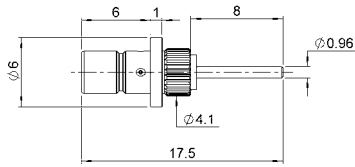

Fig. 4

Part number (Gold)	Part number (Nickel)	Fig.	Dimensions mm				Captive center contact	Panel drilling	Note
			A	B	C	D			
R114 553 000	N/A	1	15.7	6.7	1	1.5	Yes	P08	Front mount
R114 554 000		2		10.9					Rear mount
R114 603 000		3	-	-	-	Hermetically sealed			
2004-1511-000	2004-7511-000	2	15.5	10.8	0.9	1.6			Rear mount / Solder pot contact
2014-1511-000	2014-7511-000	4	-	-	-	-			Recessed front mount / Solder pot contact
2019-1511-000	2019-7511-000	1	15.5	5.9	0.9	1.6			Front mount / Solder pot contact

Receptacles

**STRAIGHT PRESS IN RECEPTACLE (male)**



Part number	Captive center contact	Panel drilling	Finish
R114 504 225	Yes	P10	Nickel

**RIGHT ANGLE BULKHEAD RECEPTACLES (male center contact)**

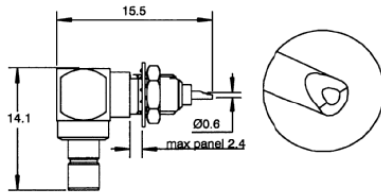

Part number	Captive center contact	Panel drilling	Finish	Note
R114 670 000	Yes	P08	Gold	Solder pot contact
2012-1511-000			Nickel	
2012-7511-000				

**STRAIGHT PCB RECEPTACLES (male and female)**

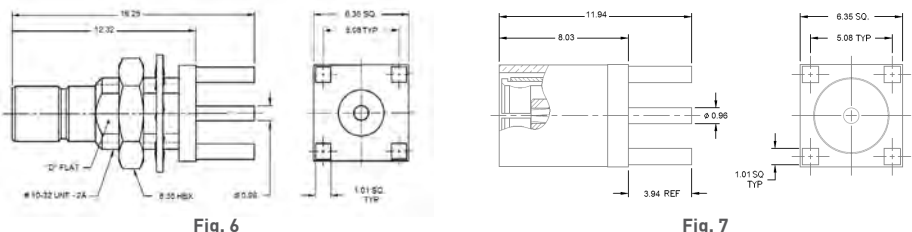
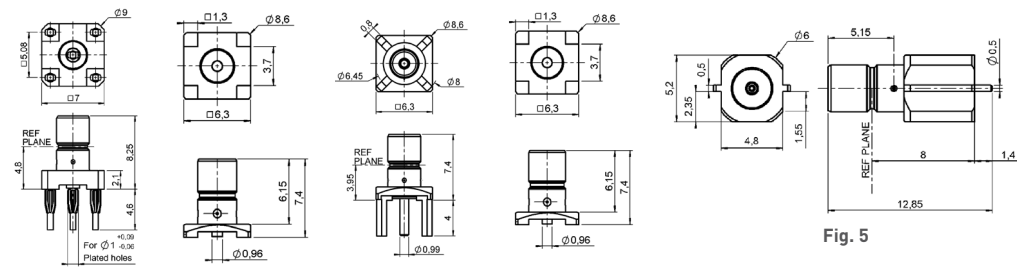

Part number (Gold)	Part number (Nickel)	Fig.	Captive center contact	Assembly instructions	Panel drilling	Note		
R114 416 020	N/A	1	Yes	-	P02	Press fit pins		
R114 423 000		5		-	-	SMT edge card		
R114 424 000		2		M01	-	-	SMT	
R114 424 100							SMT / Tape & Reel 100 pieces	
R114 425 000		4		-	-	P05	Female plug	
R114 426 000				-	-	P03	-	
2009-1511-000		2009-7511-000		3	-	-	P04	No standoff
2009-1511-050		2009-7511-050			-	-		Standoff legs
2025-1511-000		2025-7511-000		7	-	-	P04	No standoff
2109-1511-000	2109-7511-000	6	-	-	No standoff			

Receptacles

RIGHT ANGLE PCB RECEPTACLES (male center contact)

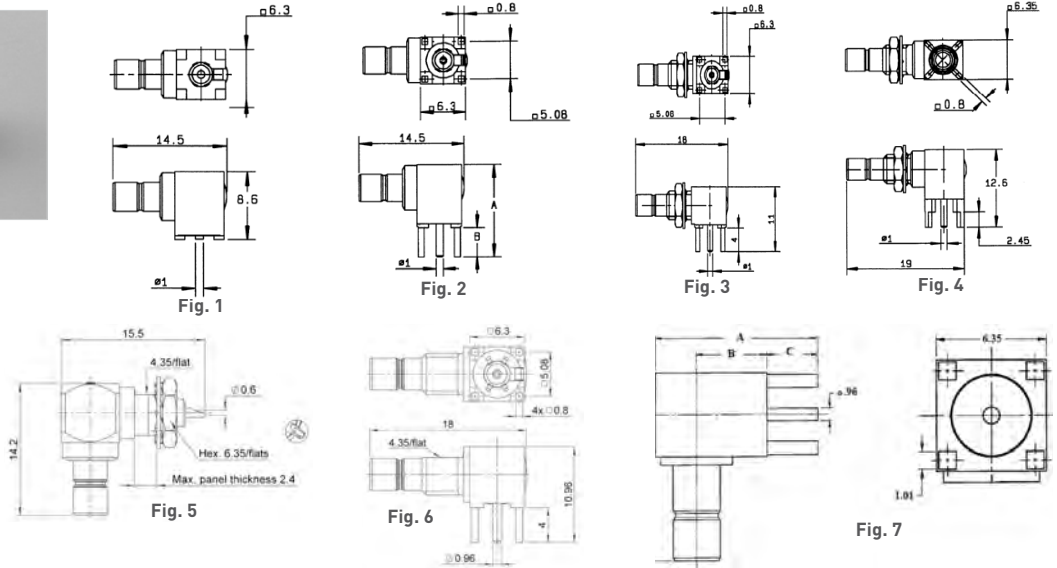

Part number (Gold)	Part number (Nickel)	Fig.	Dimensions mm				Captive center contact	Assembly instructions	Panel drilling	Note
			A	B	C	D				
R114 664 000	N/A	1	-	-	-	-	Yes	M01	Packaging 100/reel	
R114 664 120									SMT / Packaging 500/reel	
R114 665 000		2	12.6	4	-	-		-	-	
R114 665 020								-		
R114 673 020		3	-	-	-	-		-	P03	Packaging unit
R114 673 120								Rear mount		
R114 670 000		4	-	-	-	-		-	P08	Packaging 100 pieces
R114 673 823					Packaging 200 pieces					
2010-1511-000	2010-7511-000	7	10.9	3.8	3.9	12.7	-	P04	-	
2010-1511-002	2010-7511-002		12.7	5.5		14.2	-	-		

Adapters

IN SERIES ADAPTERS

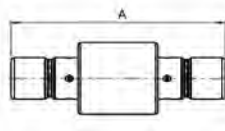

Fig. 1

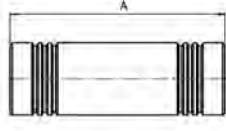

Fig. 2

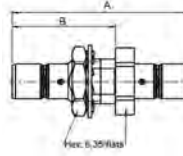

Fig. 3

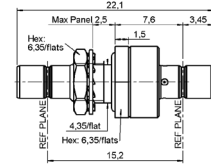

Fig. 4

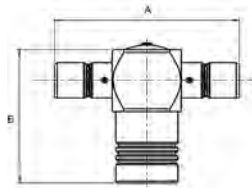

Fig. 5

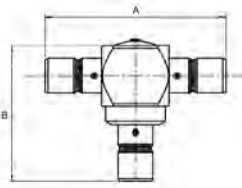

Fig. 6

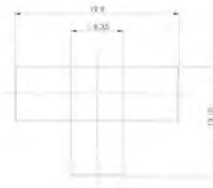

Fig. 7

Part number (Gold)	Part number (Nickel)	Fig.	Dimensions		Captive center contact	Panel drilling	Note
			A	B			
R114 703 000	N/A	1	-	-	Yes	-	Male - Male
R114 704 000		2	19	-		-	Female - Female
R114 720 000		3	-	11		P08	Bulkhead male - Male
R114 753 000		4	-	-		-	Hermetically sealed male - Male
R114 780 000		5	19	14		-	Tee female / Male - Male
R114 781 000		6	19	12.7		-	Tee male / Male - Male
5207-1501-000	5207-7501-000	3	17.5	10.7		-	Bulkhead male - Male
5222-1501-000	5222-7501-000	1	-	-		-	Male - Male
5213-1501-000	5213-7501-000	5	19	12.9		-	Tee female / Male - Male
5215-1501-000	5215-7501-000	2	17.5	-		-	Female - Female
5216-1501-000	5216-7501-000	7	-	-		-	Tee female / Female - Female
5208-1501-000	5208-7501-000						



## Introduction

Radiall offers **SMB LOCK** plugs with a 2-step connection system:

- 1 **Snap** the plug on the male connector (fig. 1)
- 2 **Lock** by pushing down the coupling nut (fig. 2)

This range:

- Is **intermateable** with the standard **SMB** male connectors
- Benefits from a low intermodulation
- Replaces the standard **SMB** and screw-on connectors in all applications requiring:
  - A fast connection
  - A reliable lock-on connection
  - Long durability
- Possibility to visually control the locking system

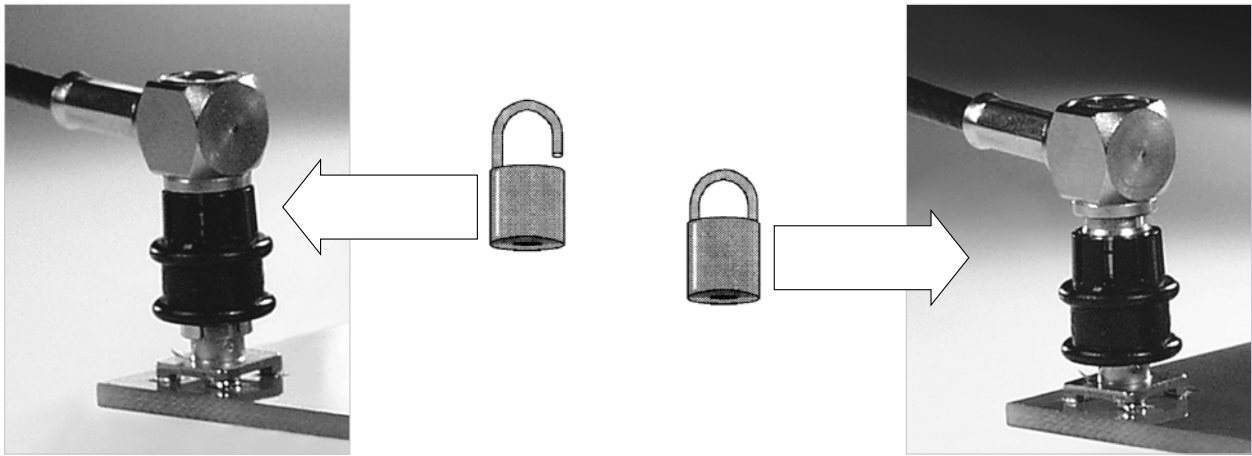
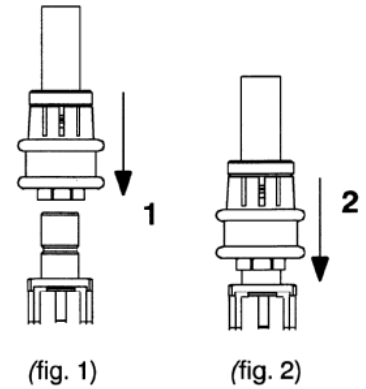

- The connector allows a 360° cable rotation
- Coupling nut

The coupling nut is made with POM (halogen free). Its standard color is black.

## Interface

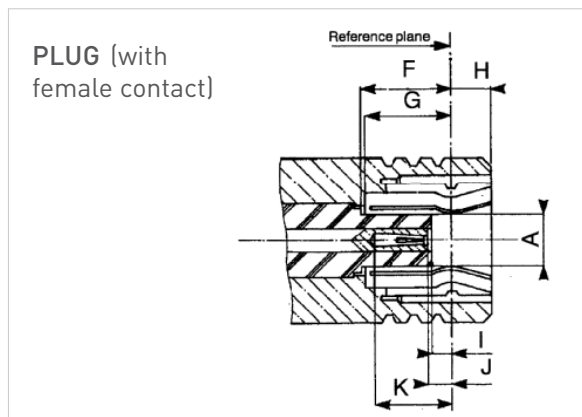

Letter	mm		inch	
	min.	max.	min.	max.
A DIA	-	2.06	-	.081
F	3.58	-	.141	-
G	3.58	-	.141	-
H	-	1.63	-	.064
I	0.18	-	.007	-
J	0.18	0.94	.007	.037
K	2.97	-	.117	-

## Characteristics

Test / Characteristics	Values / Remarks
------------------------	------------------

**ELECTRICAL CHARACTERISTICS**

Impedance	50Ω		
Operating frequency	DC to 4 GHz		
Typical V.S.W.R.		2 GHz	4 GHz
• Straight models	.085" ∅ 2.6/50	1.15 1.20	1.20 1.25
• Right angle models	.085" ∅ 2.6/50	1.05 1.15	1.15 1.25
RF Insertion loss			
• Straight models	.085" ∅ 2.6/50	0.20vF (GHz) 0.25vF (GHz)	
• Right angle models	.085" ∅ 2.6/50	0.25vF (GHz) 0.50vF (GHz)	
Testing voltage (V RMS)	.085" ∅ 2.6/50	750 1000	
Working voltage (V RMS)	.085" ∅ 2.6/50	335 335	
Insulation resistance (MΩ)	1000		

**MECHANICAL CHARACTERISTICS**

Life	500 matings min		
Cable retention force	.085" ∅ 2.6/50 ∅ 5/50/S	220 N 110 N 110 N	
Coupling nut retention force	50 N min		
Vibrations	MIL STD 202 F method 240D, condition B		

**ENVIRONMENTAL CHARACTERISTICS**

Temperature range	-35°C / + 125°C
-------------------	-----------------

**MATERIALS AND PLATING**

	Material	Plating
Bodies	Brass	BBR
Center contact	Beryllium copper	Gold
Outer contact	Bronze	-
Insulator	PTFE	-
Coupling nut	POM (halogen free)	-

Standard packaging: 100 pieces (For unit packaging, add "W" after the P/N).

## Plugs

## STRAIGHT PLUG FULL CRIMP TYPE FOR FLEXIBLE CABLES

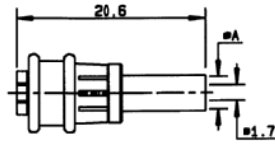

Cable group	Cable group dia	Part number	Dimensions A (mm)	Captive center contact
RG174 / RG188 / RG316	2.6/50/S	R117 082 807	3.25	Yes

## RIGHT ANGLE PLUG CRIMP TYPE FOR FLEXIBLE CABLES

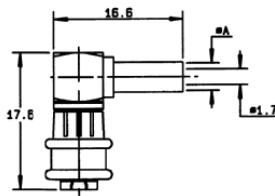

Cable group	Cable group dia	Part number	Dimensions A (mm)	Captive center contact
RG174 / RG188 / RG316	2.6/50/S	R117 186 807	3.25	Yes

## Receptacles

- Lower mating/unmating force (from 2.5 N to 6N)
- Receptacles intermateable with SMB connectors
- Gold finish

The SMB limited detent connectors have the same electrical characteristics as standard SMB connectors.

## BULKHEAD PLUG RECEPTACLE (rear fixing)

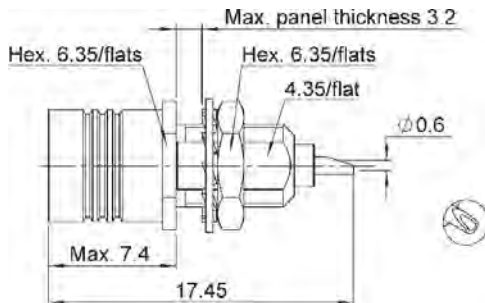

Part number	Panel drilling	Finish
R115 556 000	P08	Gold

SMB Limited Detent (SMB-A)

STRAIGHT PCB RECEPTACLES (female center contact)

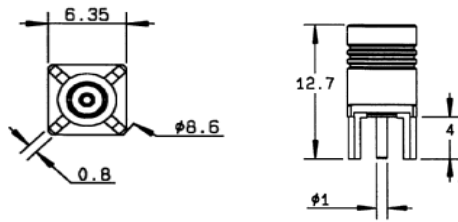
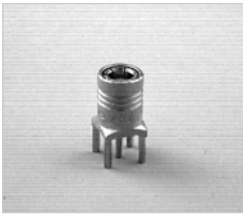

Part number	Captive center contact	Panel drilling	Finish	Packaging
R115 427 000	Yes	P05	Gold	Unit

RIGHT ANGLE PCB RECEPTACLE (female center contact)

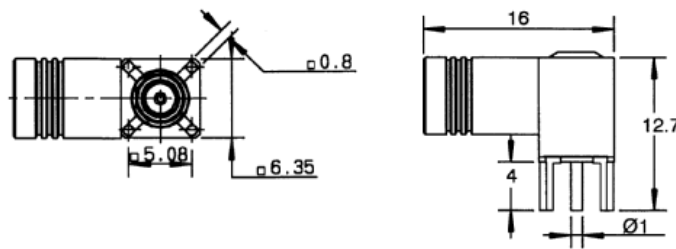

Part number	Captive center contact	Panel drilling	Finish	Packaging
R115 666 000	Yes	P04	Gold	Unit

SMB Slide-On (SUBGLIS)

Slide-on connectors (mating/unmating force: 2.2 N to 4.9 N)

The SMB slide-on connectors are completely intermateable with standard SMB and SMB limited detent connectors and can be used for **test applications**. The SMB slide-on connectors have the same electrical characteristics as standard SMB connectors.

PCB RECEPTACLES

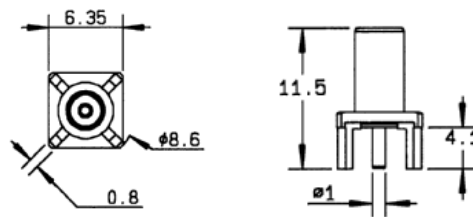
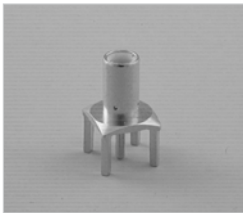

Part number	Captive center contact	Panel drilling	Finish	Packaging	Note
R116 426 000	Yes	P03	Gold	Unit	Male center contact

Panel Drilling

P01

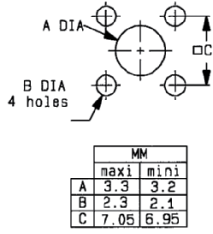

P02

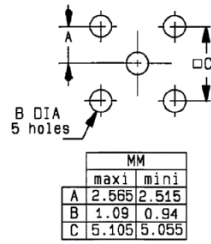

P03

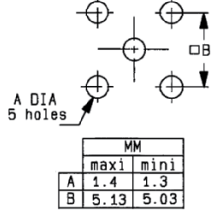

P04

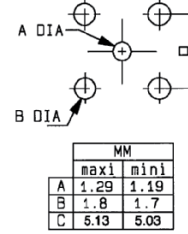

P05

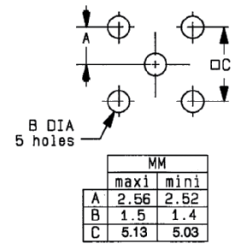

P06

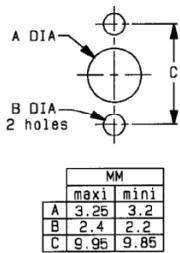

P07

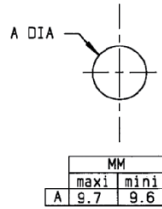

P08

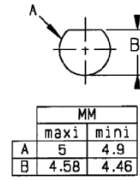

P09

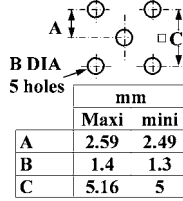

P10

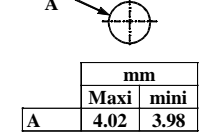

Assembly Instructions

M01

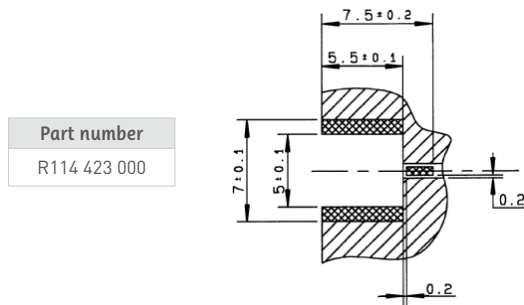

Part number
R114 423 000

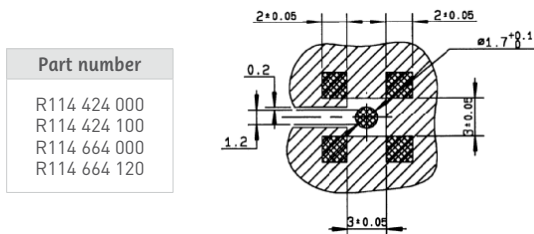

Part number
R114 424 000
R114 424 100
R114 664 000
R114 664 120

Video shadow

Part number
R113 423 000

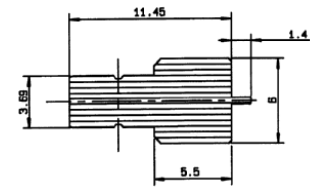

Part number
R114 424 000
R114 424 100

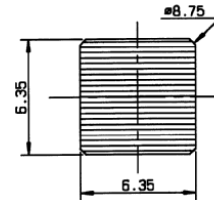

Part number
R114 664 000
R114 664 120

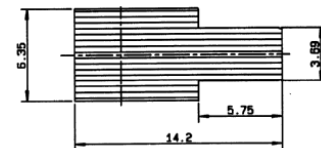

Vaccum nozzle dimensions:

Part number
R114 424 000

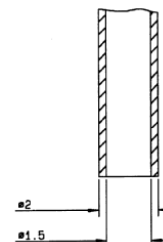

Introduction



50Ω	DC - 10 GHz
-----	-------------

GENERAL

- Subminiature coaxial connectors
- Screw-on coupling
- Plugs have female contacts
- Jacks have male contacts
- Low weight
- Reduced outline dimensions

APPLICABLE STANDARDS

- MIL-C-39012

APPLICATIONS

- Civil and military telecommunications
- Aeronautics
- Missiles
- Edge mounting applications

Interface

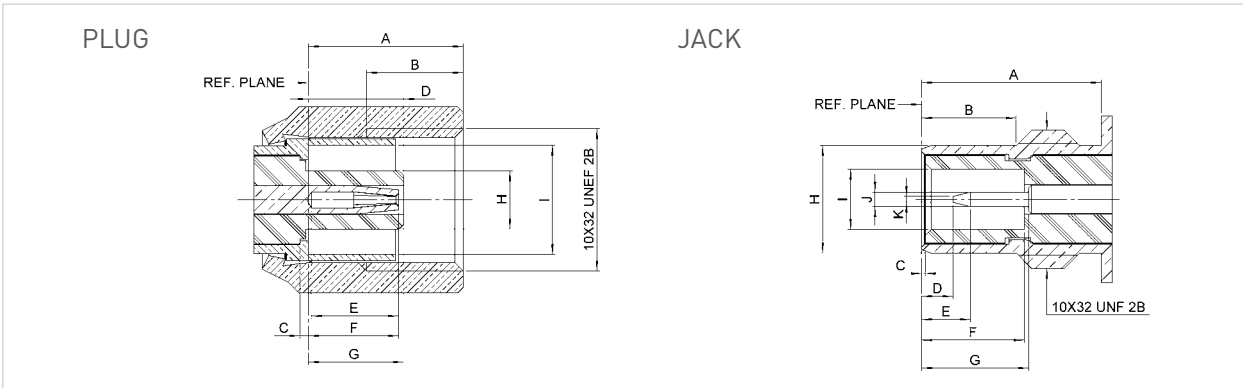

Letter	mm		inch	
	min.	max.	min.	max.
A	5.14	5.55	.202	.219
B	3.20	4.20	.126	.165
C	0.25	0.35	.010	.014
D	2.95	3.00	.116	.118
E	2.80	3.20	.110	.126
F	2.80	3.40	.110	.134
G	3.15	3.40	.124	.134
H	2.00	2.05	.079	.081
I	3.75	3.80	.148	.150

Letter	mm		inch	
	min.	max.	min.	max.
A	6.00	6.20	.236	.244
B	3.15	3.35	.124	.132
C	0.05	0.20	.002	.008
D	0.65	1.50	.026	.059
E	1.30	2.05	.051	.081
F	3.40	3.71	.134	.146
G	3.40	3.95	.134	.156
H	3.65	3.69	.144	.145
I	2.08	2.13	.082	.084
J	0.48	0.52	.019	.020
K	-	0.20	-	.008

## Characteristics

Test / Characteristics	MIL-C-39012 paragraph	Values / Remarks
------------------------	-----------------------	------------------

**ELECTRICAL CHARACTERISTICS**

Impedance	-	50Ω
Frequency range	-	DC - 10 GHz
V.S.W.R. (typ.) • Straight • Right angle	3-14	2/50 1.25 + 0.04 F (GHz) 1.40 + 0.06 F (GHz)
		2.6/50 1.20 + 0.04 F (GHz) 1.30 + 0.04 F (GHz)
Insertion loss • Straight • Right angle	3-27	0.25 dB max. at 4 GHz 0.5 dB max. at 4 GHz
RF leakage	3-26	-60 dB min between 2 and 3 GHz
Insulation resistance	3-11	1000 MΩ min
Contact resistance • Center contact (mΩ) • Outer contact (mΩ)	3-16	Initial 6 1
		After environment 8 1.5
Voltage rating (volts RMS) • At sea level • At 70000 ft (21000 m)	cable - -	2/50 250 V rms 60 V rms
		2.6/50 335 V rms 85 V rms
Dielectric withstanding voltage • At sea level • At 70000 ft (21000 m)	cable 3-17 - -	2/50 750 V rms 185 V rms
		2.6/50 1000 V rms 250 V rms
RF high potential withstanding voltage (Frequency 5 MHz) • At sea level	cable 3-23 -	2/50 500 V rms
		2.6/50 700 V rms

**MECHANICAL CHARACTERISTICS**

Durability	3-15	500 matings
Force to engage and disengage	3-5-1	torque: 16 inch-ounces max - 11.3 Ncm
Mating torque	-	35 to 50 inch-ounces - 25 to 35 Ncm
Coupling nut proof torque	-	100 inch-ounces - 71 Ncm
Coupling nut retention force	3-25	35 lbs min - 156 N min
Cabling retention force	cable 3-24	2/50 13 lbs - 58 N
		2.6/50 25 lbs - 110 N
Contact captivity	-	Axial force: 4 lbs - 18 N torque: not applicable

**ENVIRONMENTAL CHARACTERISTICS**

Operating temperature range • Standard models and hermetic • Models for semi-rigid cables	- -	-65°C / +165°C -65°C / +105°C
Temperature cycling	-	MIL-STD-202, method 102, condition C
Thermal shock	3-20	MIL-STD-202, method 107, condition B
High temperature test	-	MIL-STD-202, method 108
Corrosion (salt spray)	3-13	MIL-STD-202, method 101, condition B, 5%
Vibration	3-18	MIL-STD-202, method 204, condition D, 20g
Shock	3-19	MIL-STD-202, method 213, condition C, 100g
Moisture resistance	3-21	not applicable
Barometric pressure	3-22	MIL-STD-202, method 105, condition C
Hermetic test	-	Down to 10 <sup>-6</sup> mm Hg (Torr) Leak rate <1 x 10 <sup>-6</sup> atm/cm <sup>3</sup> /sec

**MATERIALS AND PLATING**

	Material	Plating
Bodies and male contacts	Brass, half hard per QQ-B-626	Gold to satisfy the corrosion requirements (bodies)
Female contacts and interfaces	Beryllium copper per QQ-C-530	Gold (Center contact)
Ferrules	Brass	-
Insulators	PTFE teflon	-
Gaskets	Silicone rubber	-

All dimensions are given in mm.



Plugs and Jack

**STRAIGHT PLUGS**

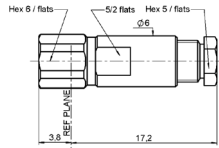

Fig. 1

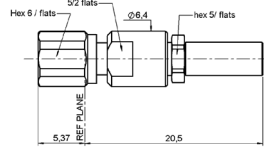

Fig. 2

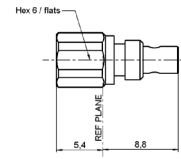

Fig. 3

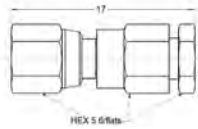

Fig. 4

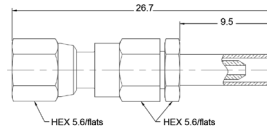

Fig. 5

Cable group	Cable group dia	Part number (Gold)	Part number (Nickel)	Fig.	Note
RG178 / RG196	2/50/S	R112 003 000	N/A	1	Clamp type
RG174 / RG316 / RG179	2.6/50+75/S	R112 005 000			
		R112 075 000			
RG405	.085"	R112 053 000		3	Solder type
RG178 / RG196	2/50/S	1002-1571-002	1002-7571-002	5	Crimp type
		1002-1551-002	1002-7551-002	4	Clamp type
RD178	2/50/D	1002-1551-005	1002-7551-005	5	Crimp type
		1002-1571-005	1002-7571-005	5	Crimp type
RG174 / RG316 / RG179	2.6/50/S	1002-1551-003	1002-7551-003	4	Clamp type
		1002-1571-003	1002-7571-003	5	Crimp type
RD316	2.6/50/D	1002-1551-019	1002-7551-019	4	Clamp type
		1002-1571-019	1002-7571-019	5	Crimp type
RG405	.085"	1002-1541-010	1002-7541-010	4	Solder clamp
RG402	.141"	1002-1541-009	1002-7541-009		

**RIGHT ANGLE PLUGS**

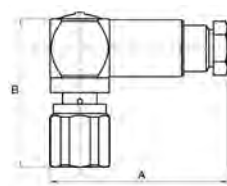

Fig. 1

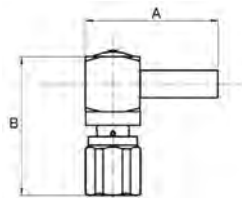

Fig. 2

Cable group	Cable group dia	Part number (Gold)	Part number (Nickel)	Fig.	Dimensions mm		Note
					A dia	B dia	
RG174 / RG316 / RG179	2.6/50+75/S	R112 165 000	N/A	1	19	15.9	Crimp type
RG178 / RG196	2/50	R112 183 000			16	15.5	
RG174 / RG316 / RG179	2.6/50+75/S	R112 186 000			2	15.3	
RG178 / RG196	2/50/S	1005-1551-002	1005-7551-002	1	14.9	13.9	Clamp type
		1105-1521-002	1105-7521-002	2	16		Crimp type
RD178	2/50/D	1005-1551-005	1005-7551-005	1	14.9		Clamp type
		1105-1521-005	1105-7521-005	2	16		Crimp type
RG174 / RG316 / RG179	2.6/50/S	1005-1551-003	1005-7551-003	1	14.9		Clamp type
		1105-1521-003	1105-7521-003	2	16		Crimp type
RD316	2.6/50/D	1005-1551-019	1005-7551-019	1	14.9		Clamp type
		1105-1521-019	1105-7521-019	2	16		Crimp type
RG405	.085"	1005-1541-010	1005-7541-010	1	14.9		Solder clamp
RG402	.141"	1005-1541-009	1005-7541-009				

Jacks and Receptacles

STRAIGHT JACK

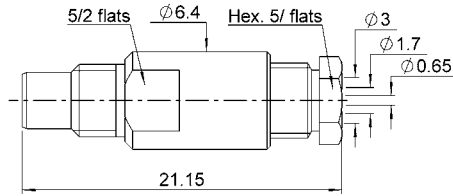

Fig. 1

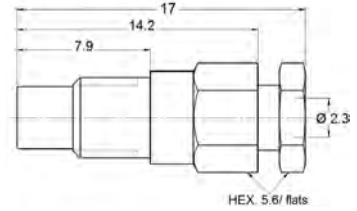

Fig. 2

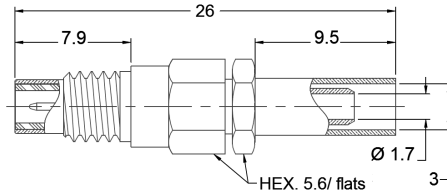

Fig. 3

Cable group	Cable group dia	Part number (Gold)	Part number (Nickel)	Note
RG174 / RG316 / RG179	2.6/50+75/S	R112 205 000	-	Clamp type
RG178 / RG196	2/50/S	1001-1551-002	1001-7551-002	
RD178	2/50/D	1001-1551-005	1001-7551-005	Clamp type
		1001-1571-005	1001-7571-005	Crimp type
RG174 / RG316 / RG179	2.6/50/S	1001-1551-003	1001-7551-003	Clamp type
		1001-1571-003	1001-7571-003	Crimp type
RD316	2.6/50/D	1001-1551-019	1001-7551-019	Clamp type
		1001-1571-019	1001-7571-019	Crimp type
RG405	.085"	1001-1571-010	1001-7571-010	Solder clamp
RG402	.141"	1001-1571-009	1001-7571-009	

BULKHEAD STRAIGHT AND RIGHT ANGLE JACKS

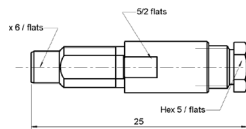

Fig. 1

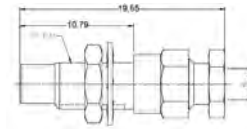

Fig. 2

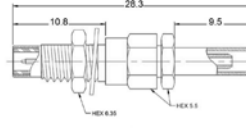

Fig. 3

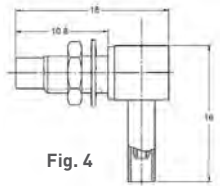

Fig. 4

Cable group	Cable group dia	Part number (Gold)	Part number (Nickel)	Fig.	Panel drilling	Note
RG178 / RG196	2/50/S	R112 303 000	-	1	P03	-
RG174 / RG316 / RG179	2.6/50+75/S	R112 305 000	-			
RG178 / RG196	2/50/S	1003-1551-002	1003-7551-002	2		Clamp type
		1003-1571-002	1003-7571-002	3		Crimp type
		1006-1551-002	1006-7551-002	4		Clamp type
		1106-1521-002	1106-7521-002			Crimp type
RD178	2/50/D	1003-1551-005	1003-7551-005	2		Clamp type
		1003-1571-005	1003-7571-005	3		Crimp type
		1006-1551-005	1006-7551-005	4		Clamp type
		1106-1521-005	1106-7521-005			Crimp type
RG174 / RG316 / RG179	2.6/50/S	1003-1551-003	1003-7551-003	2	Clamp type	
		1003-1571-003	1003-7571-003	3	Crimp type	
		1006-1551-003	1006-7551-003	4	Clamp type	
		1106-1521-003	1106-7521-003		Crimp type	

Jacks and Receptacles

**BULKHEAD STRAIGHT AND RIGHT ANGLE JACKS (CONTINUED)**

Cable group	Cable group dia	Part number (Gold)	Part number (Nickel)	Fig.	Panel drilling	Note
RD316	2.6/50/D	1003-1551-019	1003-7551-019	2	P03	Clamp type
		1003-1571-019	1003-7571-019	3		Crimp type
		1006-1551-019	1006-7551-019	4		Clamp type
		1106-1521-019	1106-7521-019			Crimp type
RG405	.085"	1003-1541-010	1003-7541-010	2		Solder clamp
		1006-1541-010	1006-7541-010	4		
RG402	.141"	1003-1541-009	1003-7541-009	2		
		1006-1541-009	1006-7541-009	4		

**SQUARE FLANGE RECEPTACLES**

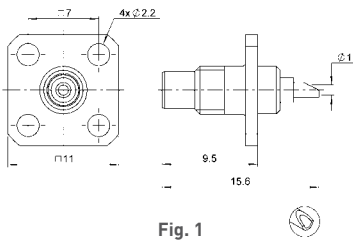

Fig. 1

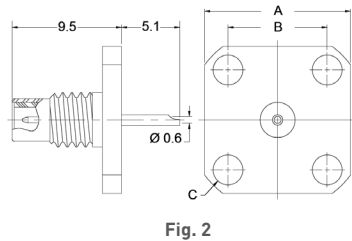

Fig. 2

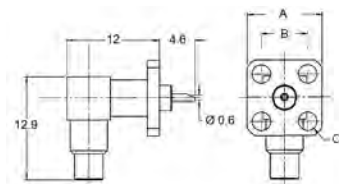

Fig. 3

Part number (Gold)	Part number (Nickel)	Fig.	Dimensions (mm)			Panel drilling
			A	B	C	
R112 403 000	N/A	1	-	-	-	P01
1484-1511-000	1484-7511-000	2	9.5	5.9	2.4	-
1486-1511-000	1486-7511-000		12.7	8.6	2.6	-
1490-1511-000	1490-7511-000	3	-	-	-	-
1488-1511-000	1488-7511-000		9.5	5.9	2.4	-

**BULKHEAD RECEPTACLES WITH SOLDER POT CONTACT**

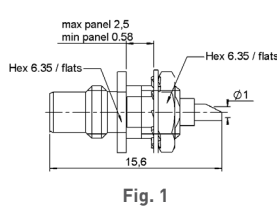

Fig. 1

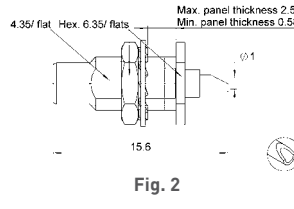

Fig. 2

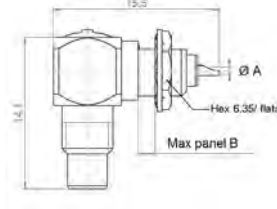

Fig. 3

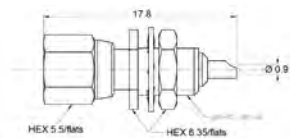

Fig. 4

Part number (Gold)	Part number (Nickel)	Fig.	Dimensions (mm)		Panel drilling	Note
			A	B		
R112 553 000	N/A	1	-	-	P03	Front mount
R112 554 000		2	-	-		Rear mount
R112 670 000		3	0.6	1.55		Front mount
1004-1511-000	1004-7511-000	2	-	-		Rear mount
1019-1511-000	1019-7511-000	1	-	-		Front mount
1012-1511-000	1012-7511-000	3	0.9	2.4		
1017 1511-000	1017 7511-000	4	-	-		

Receptacles and Adapters

PCB RECEPTACLES

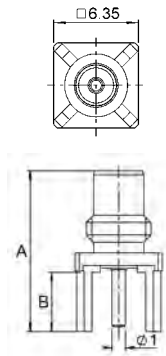

Fig. 1

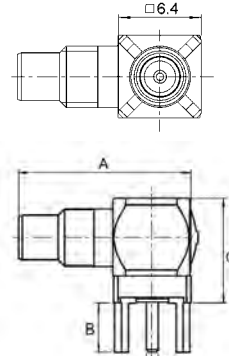

Fig. 2

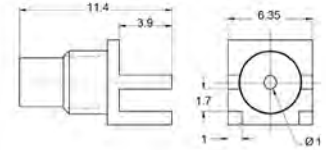

Fig. 3

Part number (Gold)	Part number (Nickel)	Fig.	Dimensions (mm)			Panel drilling	Note
			A	B	C		
R112 426 000	N/A	1	11.8	4.4	-	P02	Standoff legs
R112 665 000		2	14.2	-	12.7		
1009-1511-000	1009-7511-000	1	11.4	4	-	P04	No standoff
1010-1511-000	1010-7511-000	2	14		7		
1010-1511-001	1010-7511-001		8.8		P04 + P03	No standoff, bulkhead type	
1109-1511-000	1109-7511-000	1	16.3				
1110-1511-000	1110-7511-000	2	18	7	P04	End launch type	
1009-1511-005	1009-7511-005	3	-	-			-

IN SERIES ADAPTERS

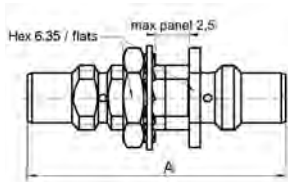

Fig. 1

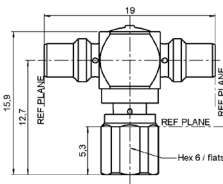
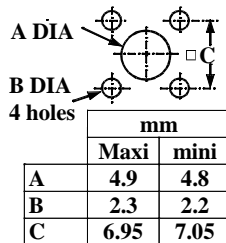

Fig. 2

Part number (Gold)	Fig.	Dimensions A (mm)	Panel drilling	Note
R112 720 000	1	19	P03	Male - Male bulkhead
R112 780 000	2	-	-	Tee male - Male / Female
5822-1501-000	1	17.5	P03	Female - Female

Panel Drilling

P01



P02

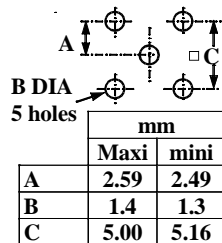

P03

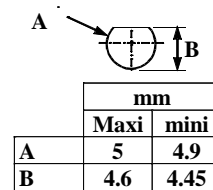

P04

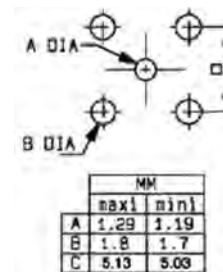

NOTE



# NOTE





## SMA/SMA-COM/BMA

R125/R124/R128

**Contents****BMA**

Introduction .....	7-4
Characteristics .....	7-5
Plugs .....	7-6
Jacks .....	7-7 to 7-8
Receptacles .....	7-8 to 7-11
Panel drilling .....	7-11 to 7-12

**SMA**

Introduction .....	7-13 to 7-14
Interface .....	7-15
Characteristics .....	7-16 to 7-17
Straight plugs .....	7-17 to 7-18
Right angle plugs .....	7-19 to 7-21
Straight jacks .....	7-22
Bulkhead jacks .....	7-23 to 7-25
Receptacles .....	7-26 to 7-30
Receptacles for microstrip .....	7-31 to 7-32
Hermetic receptacles with separate glass bead .....	7-33
Hermetic receptacles with integrated glass bead .....	7-34
Hermetic receptacles without glass bead .....	7-35
Adapters .....	7-35 to 7-36
Accessories .....	7-36
Glass beads .....	7-37
Accessories for hermetic microstrip receptacles .....	7-38
Panel drilling .....	7-38 to 7-40
Tooling for hermetic receptacles .....	7-40
Field replaceable hermetic microstrip receptacle information .....	7-41 to 7-42

**SMA-COM**

Introduction .....	7-43 to 7-44
Interface .....	7-45
Characteristics .....	7-46
Plugs .....	7-47 to 7-48
Jacks .....	7-48 to 7-49
Receptacles and switches .....	7-50 to 7-52
Panel drilling .....	7-52
Assembly instructions .....	7-53 to 7-54



**Introduction**

	<b>BMA</b>
50Ω	DC - 22 GHz

**GENERAL**

- Blind mate connector
- Slide-on coupling
- High frequency
- Float mount design allows large axial and radial misalignment

**APPLICABLE STANDARDS**

- MIL-STD-348 Fig. 321
- CEI 1169-33
- Compatible with OSP series

**APPLICATIONS**

- Airborne and ground radars
- Active electronically scanned array antennas
- Rack and panel telecommunication equipment
- Military microwave modules

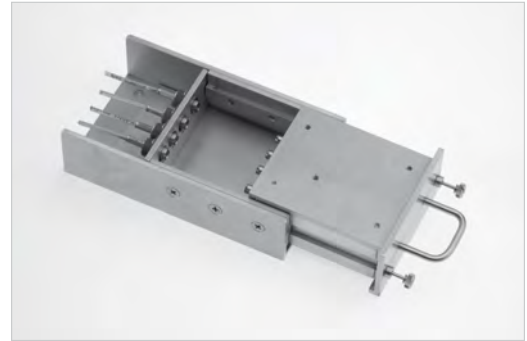

Radiall's BMA series has been designed for applications where reliability, durability and performance at high frequency is essential. BMA is a blind mate connector widely used to interconnect microwave modules with multiple coaxial ports. Float mount connectors are recommended for multiple interconnects. Contact Radiall for mounting tolerances.

**WIDE RANGE**

The BMA product range consists of cable connectors for flexible cables, semi-rigid cables and SHF cables, floating bulkhead or flange mount, PCB receptacles, press mount receptacles, screw-on receptacles, hermetic receptacles, coaxial contacts for rectangular or circular multipin connectors and adapters.

**NEW SPRING FINGERS OUTER CONTACT**

In 2007, a new outer contact was designed and introduced on all BMA female connectors. The new spring fingers outer contact provides improved performance and stability at high frequency up to 22 GHz. Old BMA female part numbers are obsolete and have been replaced with new part numbers which are listed in this catalog.

## Characteristics

Test / Characteristics	Values / Remarks
------------------------	------------------

**ELECTRICAL CHARACTERISTICS**

Impedance	50Ω	
Frequency range	DC - 22 GHz	
V.S.W.R.	.085"/ RG405 semi-rigid cable: 1.05 + 0.01 F (GHz)	
Insertion loss (typ.) dB	0.03 √ F (GHz)	
RF leakage (min.) dB	-90 + F (GHz) for gold and BBR connector body -80 + F (GHz) for passivated connector body	
Insulation resistance	≥ 5000 MΩ	
Contact resistance	Center contact: 5 mΩ max. / Outer contact: 2.5 mΩ max.	
Voltage in V. RMS • At sea level • At 70000 ft	Dielectric withstanding voltage ≥ 1000 V. 200 V.	Working voltage ≤ 335 V. 85 V.

**MECHANICAL CHARACTERISTICS**

Durability	>1000 cycles	
Force to engage	13.6 N (3 lbf) max.	
Force to disengage	0.56 N (0.13 lbf) min.	
Cable retention force	.085"/ RG405 cable	.141"/ RG402 cable
	> 136 N (30 lbf)	> 272 N (61 lbf)
Center contact retention force	27 N (6 lbf) min.	
Misalignment • Radial misalignment • Axial misalignment	Fixed mount ± 0.1mm (.004 in) 0.38mm (.015 in) max.	Float mount ± 0.51mm (.020 in) 1.52mm (.060 in) min.

**ENVIRONMENTAL CHARACTERISTICS**

Temperature range • Standard models • Semi-rigid cables	-65°C / + 165°C -65°C / +105°C
Thermal cycling	MIL-STD-202, Method 107, Condition B, -65°C / +125°C
Vibration	MIL-STD-202, Method 204, Condition D, 20 g
Shock	MIL-STD-202, Method 213, Condition A, 50 g
Bumps	CECC 22000, Paragraph 4.6.2, 4000 bumps per axis
Moisture resistance	MIL-STD-202, Method 106
Corrosion	MIL-STD-202, Method 101, Condition A, 96H
Degree of protection	IP54 (male connector with O-ring)

**MATERIALS AND PLATING**

	Material	Plating
Body/Nut	Stainless steel (standard BMA) Brass (commercial BMA)	Gold or Passivated BBR
Center contacts	Brass (male) Beryllium copper (female)	Gold over Nickel or NPGR
Outer contact	Beryllium copper	NPGR
Gaskets	Silicon rubber	-
Insulators	PTFE	-

Plugs and Contacts

**STRAIGHT PLUGS, SOLDER TYPE FOR SEMI-RIGID CABLES**

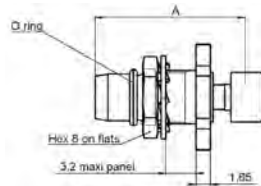

Fig. 1

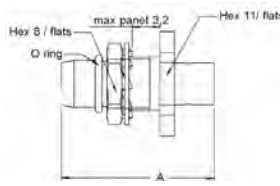

Fig. 2

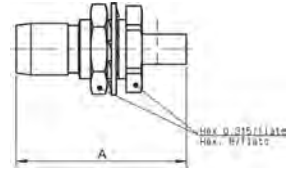

Fig. 3

Cable group	Cable group dia.	Part number	Fig.	Dimension A (mm)	Panel drilling	Body	Finish	Captive center contact	Note	
RG405	.085"	R128 052 901	1	17	P01	Stainless steel	Passivated	Yes (epoxy)	Crimp type, easy installation	
		R128 052 000	2				Gold		-	
		R128 052 827	3				BBR	Yes (4 indents)	No O-ring	
RG402	.141"	R128 055 000	2	17.6		P01	Stainless steel	Gold	Yes (epoxy)	-
		R128 055 827	3					BBR		Yes (4 indents)

**STRAIGHT BULKHEAD PLUGS CRIMP TYPE FOR FLEXIBLE CABLE**

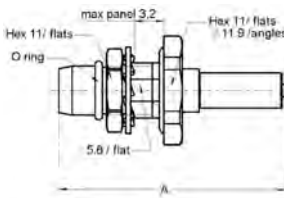

Fig. 1

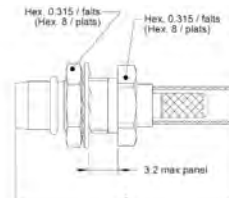

Fig. 2

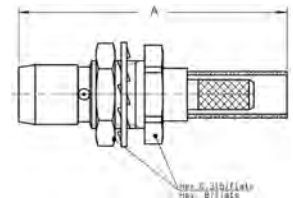

Fig. 3

Cable group	Cable group dia.	Part number	Fig.	Dimension A (mm)	Panel drilling	Body & finish	Captive center contact	Note
RG174 / RG316	2.6/50/S	R128 081 001	1	24.6	P02	Stainless steel passivated	Yes (barb)	Waterproof
		R128 083 001	2				Yes (epoxy)	-
		R128 083 827	3					
RD316	2.6/50/D	R128 084 827	3	24.2	P01	Brass BBR	Yes (4 indents)	No O-ring
RG142 / RG223 / RG400	5/50D	R128 088 827						

**STRAIGHT CONTACTS SIZE 8 FOR MIL-STD-38999 CONNECTORS SOLDER TYPE**

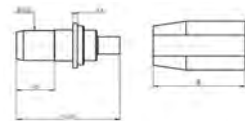

Fig. 1

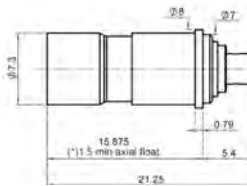

Fig. 2

Cable group	Cable group dia.	Part number	Body & finish	Fig.	Captive center contact	Gender
RG405	.085"	R128 053 000	Stainless steel gold plated	1	Yes (epoxy)	Pin
		R128 294 710		2		Socket
RG402	.141"	R128 056 000		1		Pin
		R128 296 710		2		Socket

Jacks

**STRAIGHT FLOATING JACKS SOLDER TYPE FOR SEMI-RIGID CABLE**

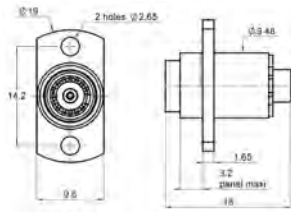

Fig. 1



Fig. 2

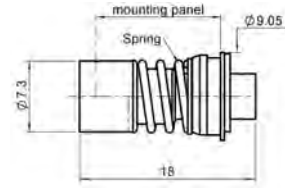

Fig. 3

Cable group	Cable group dia.	Part number	Fig.	Panel drilling	Body & finish	Captive center contact	Panel mount
RG405	.085"	R128 292 700	1	P03	Stainless steel gold plated	Yes (epoxy)	2-hole flange
		R128 292 727			Brass BBR	Yes (4 indents)	
		R128 293 702	2	P18			Bulkhead
RG402	.141"	R128 294 700	3	P04	Stainless steel gold plated	Yes (epoxy)	Snap-in
		R128 296 700					
		R128 295 700	1	P03	Stainless steel gold plated	Yes (epoxy)	2-hole flange
		R128 295 727			Brass BBR		

**STRAIGHT FLOATING JACKS CRIMP TYPE FOR FLEXIBLE CABLE**

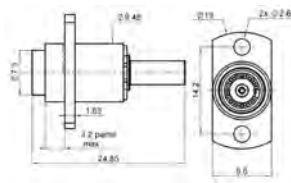

Fig. 1

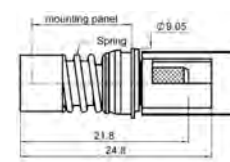
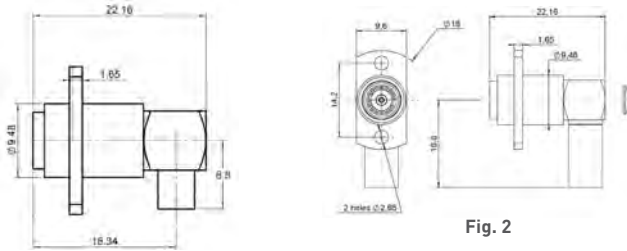

Fig. 2

Cable group	Cable group dia.	Part number	Fig.	Panel drilling	Body & finish	Captive center contact	Panel mount
RG174 / RG316	2.6/50S	R128 263 707	1	P03	Brass BBR	Yes (4 indents)	2-hole flange
RD316	2.6/50D	R128 264 707					
RG142 / RG223 / RG400	5/50/D	R128 268 717					
RG174 / RG316	2.6/50/S	R128 263 711			Stainless steel passivated	Yes (epoxy)	Snap-in
RG142 / RG223 / RG400	5/50/D	R128 268 701					
RG174 / RG316	2.6/50/S	R128 233 701	2	P04	Stainless steel passivated	Yes (epoxy)	Snap-in
RG142 / RG223 / RG400	5/50/D	R128 238 701					

Jacks and Receptacles

RIGHT ANGLE FLOATING JACKS FOR SEMI-RIGID AND FLEXIBLE CABLE



Cable group	Cable group dia.	Part number	Fig.	Panel drilling	Body & finish	Captive center contact	Note
RG402	.141"	R128 359 707	1	P03	Brass BBR	Yes (4 indents)	Solder type
RG405	.085"	R128 360 701 R128 360 717			Stainless steel passivated	Yes (epoxy)	
RG142 / RG223 / RG400	5/50/D	R128 368 707	2		Brass BBR	Yes (4 indents)	Crimp type

STRAIGHT SMT MALE RECEPTACLES

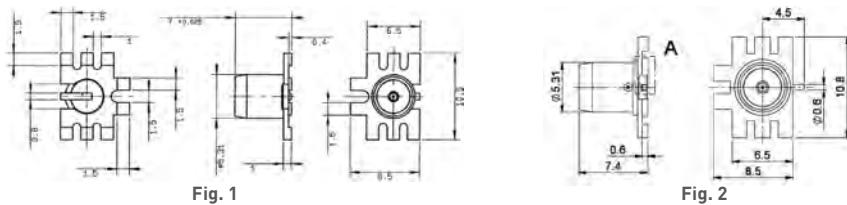

Part number	Fig.	Body & finish	Captive center contact	Note
R128 424 848	1	Brass, tin plated	Yes (4 indents)	-
R128 424 860	2	Brass NPGR		Tape & Reel 250pcs

PCB MALE RECEPTACLES

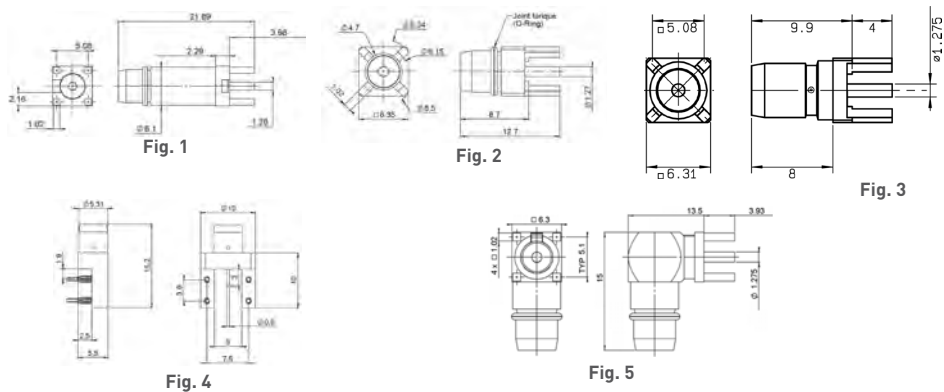

Part number	Fig.	Panel drilling	Body & finish	Captive center contact	Note
R128 425 110	1	P09	Stainless steel gold plated	Yes (barb)	-
R128 425 300	2			Yes (epoxy)	-
R128 425 820	3	P07	Brass gold plated	Yes (4 indents)	No O-ring
R128 405 161	4	-			Press-fit edge-card type No O-ring
R128 665 820	5	P07			No O-ring
R128 665 100		P09	Stainless steel gold plated	Yes	-

Receptacles

PCB FEMALE RECEPTACLES

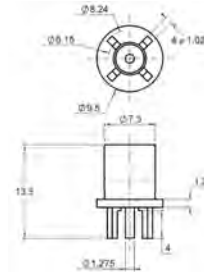

Fig. 1

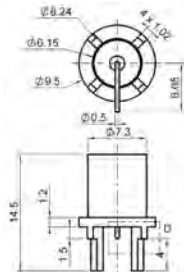

Fig. 2

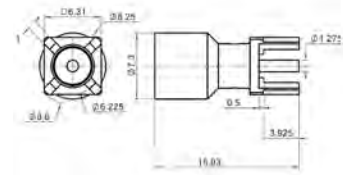

Fig. 3

Part number	Fig.	Panel drilling	Body & finish	Captive center contact
R128 426 700	3	P09	Brass gold plated	Yes (4 indents)
R128 426 710	1	P10	Stainless steel gold plated	Yes (epoxy)
R128 427 700	2	P11		

NARROW AND SQUARE FLANGE EXTENDED DIELECTRIC MALE RECEPTACLES

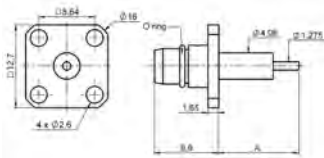

Fig. 1

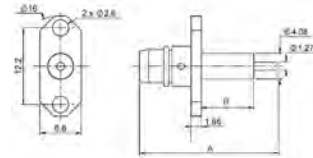

Fig. 2

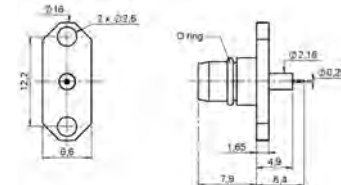

Fig. 3

Part number	Fig.	Dimension		Panel drilling	Body & finish	Captive center contact	Panel mount	Note
		A (mm)	B (mm)					
R128 444 201	1	12.4	8.4	P06	Stainless steel passivated	Yes (epoxy)	4 hole flange	-
R128 444 307		10.7	5.6		Brass BBR	Yes (4 indents)		No O-ring
R128 474 201	2	22.3	8.4	P05	Stainless steel passivated	Yes (epoxy)	2 hole flange	-
R128 474 211		17.4	5		Brass BBR	Yes (4 indents)		
R128 474 847		16.4						
R128 474 857		22.3	8.4					
R128 484 001	3	-	-	P13	Stainless steel passivated	Yes (epoxy)		

NARROW AND SQUARE FLANGE EXTENDED DIELECTRIC FEMALE RECEPTACLES

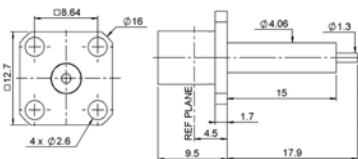

Fig. 1

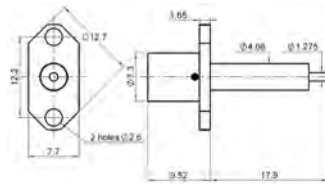
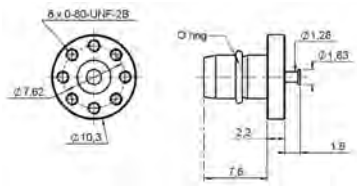

Fig. 2

Part number	Fig.	Panel drilling	Body & finish	Captive center contact	Note
R128 414 701	1	P06	Stainless steel passivated	Yes (epoxy)	Square flange
R128 464 701	2	P12			2 hole flange

Receptacles

**SPECIAL FLANGE MALE RECEPTACLE**



Part number	Panel drilling	Body & finish	Captive center contact	Note
R128 545 011	P16	Stainless steel passivated	No	Turret contact type

**NARROW FLANGE REPLACEABLE MALE RECEPTACLES**

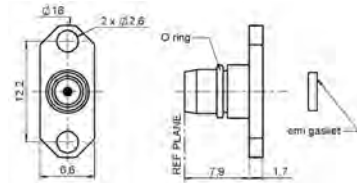

Part number	Panel drilling	Body & finish	Captive center contact	Accept pin diameter	Note
R128 490 021	P13	Stainless steel passivated	Yes (epoxy)	0.93 mm	No EMI gasket
R128 481 001				0.3 mm	EMI gasket
R128 481 011				0.5 mm	

**SCREW-ON AND PRESS-FIT MALE RECEPTACLES**

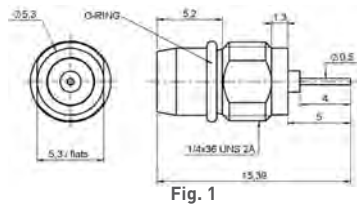

Fig. 1

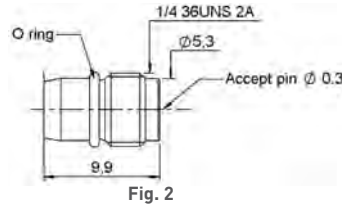

Fig. 2

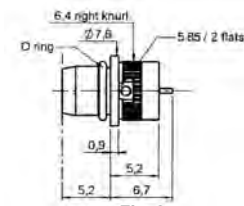

Fig. 3

Part number	Fig.	Panel drilling	Body & finish	Captive center contact	Panel mount	Note
R128 555 101	1	P14	Stainless steel passivated	Yes (epoxy)	Screw-on	Cylindrical
R128 556 001	2	P15				Socket
R128 595 001	3	P08			Press-fit	Cylindrical

**SCREW-ON HERMETIC RECEPTACLES WITH EMI GASKET (with integrated glass bead)**

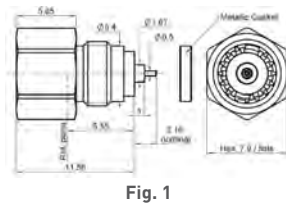

Fig. 1

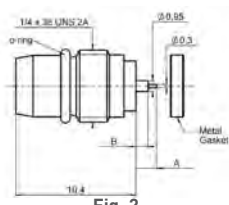

Fig. 2

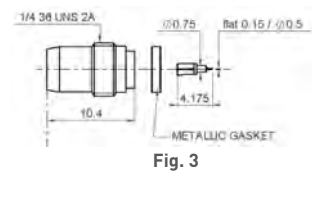

Fig. 3

Part number	Fig.	Dimension		Body & finish	Captive center contact	Note
		A (mm)	B (mm)			
R128 609 701	1	-	-	Stainless steel passivated	Yes	Female
R128 639 000	2	1.8	1			
R128 639 001		3	1.05	Stainless steel gold plated	Male	
R128 639 020		1.8				
R128 639 100		3	-	-	Stainless steel passivated	Male, with auxiliary contact, no O-ring



Receptacles

FEMALE-FEMALE STRAIGHT ADAPTER

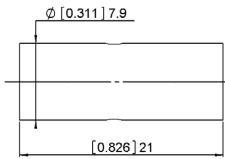

Part number	Body & finish	Captive center contact
R128 705 711	Stainless steel passivated	Yes (epoxy)

Panel Drilling

P01

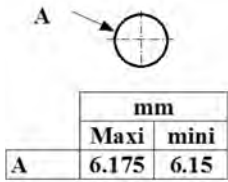

P02

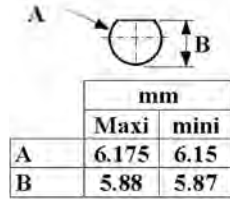

P03

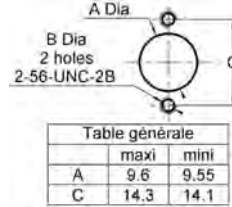

P04

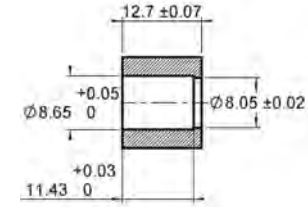

P05

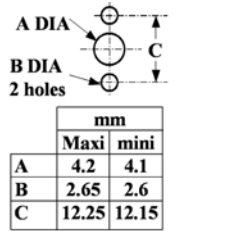

P06

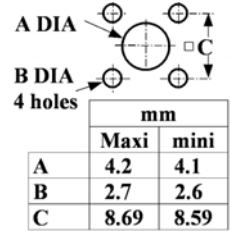

P07

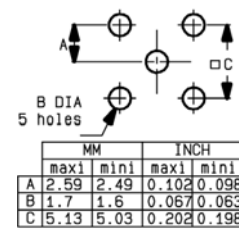

P08

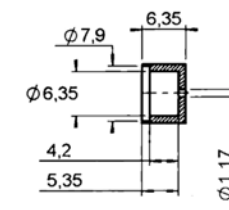

P09

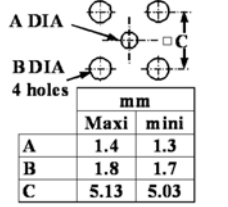

P10

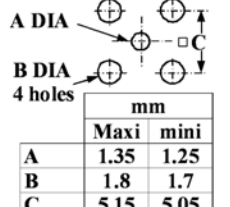

P011

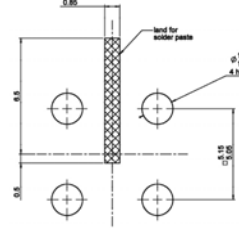

P12

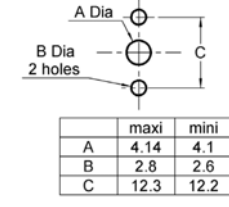

P13

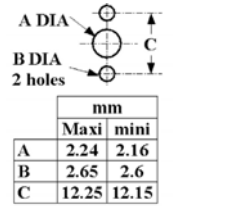

P14

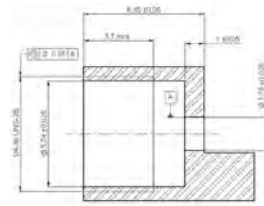

P15

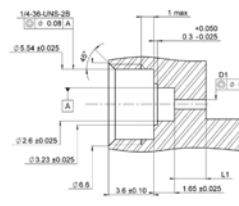

P16

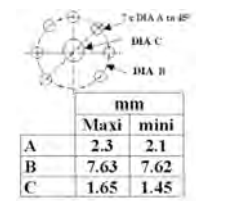



## Panel Drilling

## HERMETIC GLASS BEAD RECEPTACLES

## P17

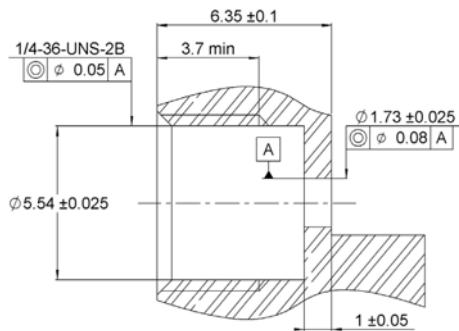

## INSTALLATION TOOLS FOR HERMETIC RECEPTACLES

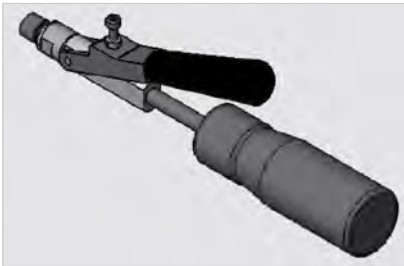

Part number	Body & finish	Captive center contact
R282 340 000	280 N.cm	Tool for male receptacles R128 639 xxx

## Introduction

Radiall stainless steel SMA connectors have been designed for applications where reliability, durability, robustness and high frequency are critical.

### • WIDE RANGE

The stainless steel SMA range offers cable connectors for both flexible or semi-rigid cables, panel and PCB mount receptacles, press mount, microstrip, universal, through hole pins and end launch connectors. In series adapters and between series adapters including PUSH-ON interface are also available.

All Radiall stainless steel SMA connectors can be mated with Radiall commercial (brass) SMA connectors.

### • CONVENIENT 3-PIECE DESIGN ON MOST CONNECTORS FOR FLEXIBLE CABLES

- For straight models: single piece body + center contact + outer ferrule
- For right angle models: single piece body + cap + outer ferrule

### • FAST AND RELIABLE CABLE ATTACHMENT

The cable connectors can be either fully crimped or soldered/crimped, offering full flexibility for high volume production with standard manual or pneumatic tooling: fast and reliable.

- The center contact can be either crimped or soldered
- The outer contact is attached to the cable by crimping a ferrule

### • SIMPLE SNAP-IN CENTER CONTACT CAPTIVATION (FOR FULL CRIMP MODELS)

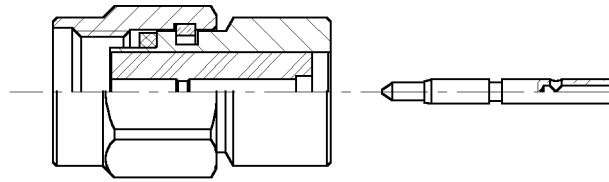

The relative position of the center contact into the interface is mechanically guaranteed by the snapping of the insulator inner shoulder into the groove of the center contact.

This design facilitates the captivation operation in contrast of other designs, requiring 2 insulators to provide contact retention.

### • EXTENDED FREQUENCY SMA DC-27 GHz

Radiall offers an extended frequency SMA range allowing coaxial system operation up to 27 GHz. This series mates with the standard SMA series and maintains the same mechanical characteristics (part numbers ending with 700, 701 or 702).

### • SOLDERLESS ATTACHMENT TO SEMI-RIGID CABLE

Radiall's SMA crimp connector series offers an exciting alternative for assembling SMA connectors to semi-rigid cable. The main advantages of these connectors are: time savings, repeatability and performance.



## Introduction



- **SMA HERMETIC**

Hermetic connectors are required to maintain a pressurized or vacuum environment inside a micro-electronic package. Radiall offers 3 types of hermetic connectors:

1. **Field replaceable hermetic receptacles with separate glass bead**

(leakage rate below  $10^{-8}$  atm.cm<sup>3</sup>/sec)

The hermeticity level is guaranteed by the glass bead soldered into the package. A large selection of glass beads is available from dia 0.3 to 0.5 mm. They are usually ordered separately from the receptacle. The receptacle can be removed (field replaceable) from the package for maintenance without any risk of leakage. The field replaceable receptacle is recommended when a high number of matings is required.

2. **Hermetic receptacles with integrated glass bead**

(leakage rate below  $10^{-8}$  atm.cm<sup>3</sup>/sec)

The glass bead is already in place inside the receptacle, hermeticity is guaranteed by a solder joint between the receptacle and the package or with a metallic compression gasket. Screw-on receptacle with metallic compression gasket offers superior climatic resistance: -65°C +200°C.

3. **Hermetic receptacles without glass bead**

(leakage rate below  $10^{-6}$  atm/cm<sup>3</sup>/sec)

A good hermeticity level is obtained with a metallic gasket at a cost advantage compared to glass beads.



50Ω

DC - 18 GHz  
DC - 27 GHz**GENERAL**

- Sub-miniature coaxial connectors
- Screw-on coupling
- High RF performance
- 2 plating options:
  - passivated stainless steel
  - gold plated
- Wide hermetically sealed range
- Space qualified range of products
- SMA extended frequency 27 GHz

**APPLICABLE STANDARDS**

- MIL-C-39012
- EC 169-1
- CECC 22110
- CECC 22111 - 801 to 808
- BS 9210 N006

**SPACE QUALIFIED/APPROVALS**

(For space range)

- SCC 3402 (ESA)
- CNES

**APPLICATIONS**

- Civil & Military Telecommunications
- Civil & Military Aeronautics
- Military equipment
- Space
- Measurement systems

**PLUG**

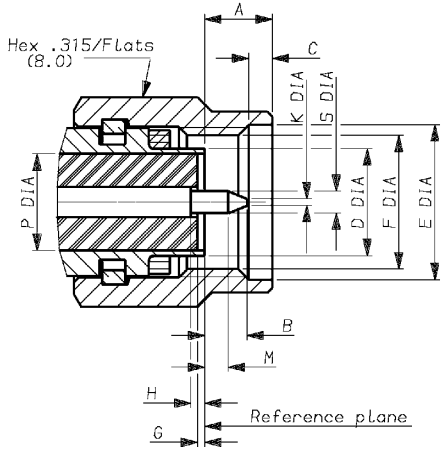

**JACK**

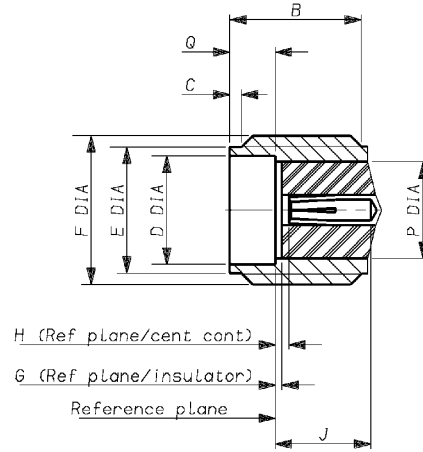

Letter	mm		inch	
	min.	max.	min.	max.
A	-	3.43	-	.135
B	-	2.54	-	.100
C	0.38	1.14	.015	.045
D DIA	-	4.59	-	-
E	6.35	-	.250	-
F DIA	1/4 36 UNS 2B			
G*	0.0	-0.20	0.0	-.008
H*	0.0	-0.25	0.0	-.010
J	-	-	-	-
K DIA	-	0.38	-	.015
M	1.27	-	.050	-
P DIA	4.10 nom.		.161 nom.	
Q DIA	-	-	-	-
S DIA	0.90	0.94	.035	.037

Letter	mm		inch	
	min.	max.	min.	max.
A	-	-	-	-
B	4.31	-	.170	-
C	0.38	1.14	.015	.045
D DIA	4.596	-	.181	-
E DIA	5.28	5.49	.208	.216
F DIA	1/4 36 UNS 2A			
G*	0.0	-0.20	0.0	-.008
H*	0.0	-0.25	0.0	-.010
J	2.92	-	.115	-
K	-	-	-	-
M	-	-	-	-
P DIA	4.10 nom.		.161 nom.	
Q	1.88	1.98	.074	.078
S DIA	-	-	-	-

**NOTE:**  
Means behind ref plane

## Characteristics

Test / Characteristics	Values / Remarks
------------------------	------------------

## ELECTRICAL CHARACTERISTICS

Impedance		50Ω						
Frequency range		DC - 18 GHz					Extended	
V.S.W.R. (typ.) • Straight connector  • Right angle connector	Frequency	1 GHz	2.4 GHz	6 GHz	12.4 GHz	18 GHz	27 GHz	
	.085"	1.01	1.01	1.04	1.06	1.06	1.12	
	.141"	1.01	1.01	1.01	1.03	1.05	1.10	
	2.6/50S	1.05	1.07	1.12	1.15	-	-	
	5/50S	1.04	1.05	1.10	1.12	-	-	
	.085"	1.01	1.02	1.06	1.14	-	-	
	.141"	1.01	1.02	1.08	1.10	-	-	
	2.6/50S	1.06	1.15	1.18	1.24	-	-	
	5/50S	1.06	1.15	1.15	1.25	-	-	
	Insertion loss (typ.) dB • Straight connector  • Right angle connector	.085"	0.03	0.03	0.05	0.08	0.10	0.15
		.141"	0.02	0.02	0.02	0.02	0.02	0.10
		2.6/50S	0.06√F (F in GHz) max					
5/50S		0.06√F (F in GHz) max						
.085"		0.04	0.04	0.04	0.08	-	-	
.141"		0.04	0.05	0.06	0.09	-	-	
2.6/50S		0.08	0.08	0.10	0.10	-	-	
5/50S		0.04	0.12	0.12	0.25	-	-	
RF leakage (dB max) • Connectors for semi-rigid cables solder attachment • Connectors for flexible cables crimp attachment • Receptacles		- 90 + F (GHz)						
		-						
		- 60 + F (GHz)						
		- 100 + F (GHz)						
Insulation resistance		5 000 MΩ min						
Contact resistance • Outer conductor • Inner conductor		After tests 4 mΩ 3 mΩ			Initial 3 mΩ 2 mΩ			
Working voltage in VRMS • Sea level • 70 000 ft (21000 m)	.085", RG 405, KS 1	.141", RG 402, KS 2	RG 174, 188, 316, KX 3, KX 22		RG 55, 142, 223, KX 23			
	350	500	250		335			
	85	125	65		85			
Dielectric withstanding voltage in VRMS		1000	1500	750	1000			
RF testing voltage at in VRMS		670	1000	500	670			

## MECHANICAL CHARACTERISTICS

Durability		500 matings			
Force to engage and disengage		23 Ncm - (2 inch pounds)			
Recommended coupling nut torque		80 to 115 Ncm - (7 to 10 inch pounds)			
Coupling nut retention force		270 N - (60 Lbs)			
Cable retention force	.085", RG 405, KS 1	.141", RG 402, KS 2	RG 174, 188, 316, KX 3, KX 22		RG 55, 142, 223, KX 23
	135 N (30 Lbs)	270 N (60 Lbs)	110 N (25 Lbs)	180 N (40 Lbs)	
Center contact retention force • Axial • Torque		27 N 2.8 N			

Characteristics

Test / Characteristics	Values / Remarks
<b>ENVIRONMENTAL CHARACTERISTICS</b>	
Temperature range • Standard models • Semi-rigid cables • R125 753 000	-65°C / + 165°C -65°C / +105°C -40°C / +100°C
Thermal shock	MIL STD 202, method 107, condition B
High temperature test	MIL STD 202, method 108
Corrosion (salt spray)	MIL STD 202, method 101, condition B
Vibration	MIL STD 202, method 204, condition D, 20g
Shock	MIL STD 202, method 213
Moisture resistance	MIL STD 202, method 106
Hermetic test	Down to 10 <sup>-6</sup> mmHg (Torr) leakage rate < 10 <sup>-6</sup> atm/cm <sup>3</sup> /sec
Barometric pressure	MIL STD 202, method 105, condition C

MATERIALS AND PLATING

	Material	Plating
Body/nut	Stainless steel	Passivated or gold plated (bodies)
Center contacts	Beryllium copper (female) Brass (male)	Gold plated
Gaskets	Silicone rubber	-
Insulators	PTFE	-

Standard packaging: 100 pieces

All dimensions are given in mm.

Straight Plugs

STRAIGHT PLUGS FOR FLEXIBLE CABLES

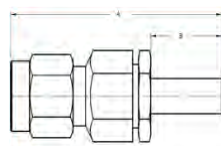
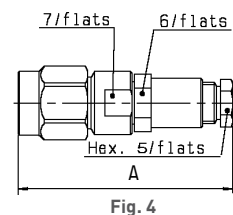
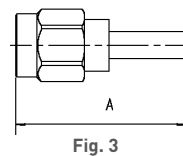
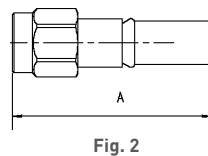
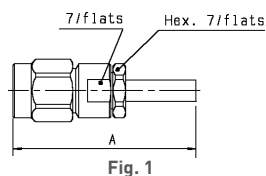

Cable group	Cable group dia.	Part number (Gold)	Part number (Passivated)	Fig.	Dimensions A (mm)	Captive center contact	Assembly type	Note
RG178 / RG196	2/50/S	R125 069 000	-	1	26	Yes	Crimp	-
Special	2.2/50/D	-	R125 002 200	4	25	Yes	Clamp	-
RG174 / RG316	2.6/50/S	R125 071 120	-	3	24.3	Yes	Crimp	Single piece body
		R125 072 000	R125 072 001	2	21.1	No		Single piece body heatshrink sleeve
		R125 073 000	R125 073 001	1	26	Yes	-	
		R125 091 000	R125 091 001	4	2	Yes	Clamp	-
RD316	2.6/50/D	R125 072 080	-	2	20.1	No	Crimp	Single piece body heatshrink sleeve
		R125 072 220	-	3	23.4	Yes		Single piece body
RG58 / RG141	5/50/S	R125 075 000	-	3	24.9	No	Crimp	Single piece body heatshrink sleeve
		R125 077 000	-	1	28	Yes		
RG142 / RG223 / RG400	5/50/D	R125 076 000	R125 076 001	3	25	No		
		R125 078 000	R125 078 001	1	28	Yes		

Straight Plugs

STRAIGHT PLUGS FOR FLEXIBLE CABLES (CONT'D)

Cable group	Cable group dia.	Part number (Gold)	Part number (Passivated)	Fig.	Dimensions A (mm)	Dimensions B (mm)	Captive center contact	Assembly type	Note
RG178 / RG196	2/50/S	9001-1023-002	9001-9023-002	3	20.3	-	No	Crimp	For passivated version, coupling nut only is passivated
		9001-1033-002	9001-9033-002					Solder	
		9001-1553-002	9201-9553-002	5	19.5	0	Yes	Clamp	
		9001-1573-002	9201-9573-002					-	
RD178	2/50/D	9001-1023-005	9001-9023-005	3	20.3	-	No	-	
		9001-1033-005	9001-9033-005					Solder	
		9001-1553-005	9001-9553-005	5	19.5	0	Yes	Clamp	
		9001-1573-005	9001-9573-005					Crimp	
RG174/RG316	2.6/50/S	9001-1023-003	9001-9023-003	3	20.3	-	No	-	
		9001-1033-003	9001-9033-003					Solder	
		9001-1553-003	9001-9553-003	5	19.5	0	Yes	Clamp	
		9001-1573-003	9001-9573-003					-	
RD316	2.6/50/D	9001-1023-019	9001-9023-019	3	20.3	-	No	-	
		9001-1033-019	9001-9033-019					Solder	
		9001-1553-019	9001-9553-019	5	19.5	0	Yes	Clamp	
		9001-1573-019	9001-9573-019					Crimp	
RG58/RG141	5/50/S	9001-1023-006	9001-9023-006	3	20.3	-	No	-	
		9001-1033-006	9001-9033-006					Solder	
		9001-1553-006	9001-9553-006	5	19.5	0	Yes	Clamp	
		9001-1573-006	9001-9573-006					Crimp	
RG142/RG223/RG400	5/50/D	9001-1023-001	9001-9023-001	3	20.3	-	No	-	
		9001-1033-001	9001-9033-001					Solder	
		9001-1553-001	9001-9553-001	5	19.5	0	Yes	Clamp	
		9001-1573-001	9001-9573-001					Crimp	

STRAIGHT PLUGS SOLDER TYPE FOR SEMI-RIGID CABLES

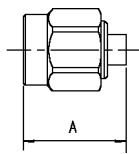

Fig. 1

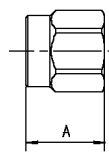

Fig. 2

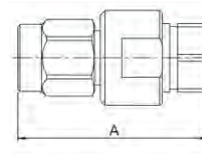

Fig. 3

Cable group	Cable group dia.	Part number (Gold)	Part number (Gold/Passivated coupling nut)	Part number (Nickel)	Fig.	Dimensions A (mm)	Captive center contact	Note
RG405	.085"	R125 052 000	R125 052 002	-	1	11.1	No	Single piece body
		R125 052 170	-	-				Loose parts
		R125 052 500	-	-				Retractable coupling nut / Single piece body
		-	R125 052 702	-				DC-27 GHz Single piece body
RG402	.141"	R125 054 000	R125 054 002	-	2	8.5	N/A	Without center contact
		R125 054 500	-	-		7.5	N/A	Without center contact / Retractable coupling nut
		R125 055 000	R125 055 002	-	1	11.2	no	Single piece body
		R125 055 500	-	-				Retractable coupling nut / Single piece body
		-	R125 055 702	-				DC-27 GHz without center contact
-	R125 057 002	-	N/A	Without center contact				
RG401	.250"	R125 051 000	-	-	3	21.1	No	Two pieces body

## Straight Plugs

## STRAIGHT PLUGS SOLDER TYPE FOR SEMI-RIGID CABLES (CONT'D)

Cable group	Cable group dia.	Part number (Gold)	Part number (Gold/Passivated coupling nut)	Part number (Nickel)	Fig.	Dimensions A (mm)	Captive center contact	Note
RG405	.085"	9501-1593-010	9501-9593-010	-	3	19.5	Yes	Solder-Clamp
		9401-1083-010	-	9401-7083-010	1	11.2	No	Solder type
		9401-1083-210	-	9401-7083-210		8.4		
		9401-1583-010	-	9401-7583-010		11.2	Yes / For one-step cable assembly	
RG402	.141"	9501-1593-009	9501-9593-009	-	3	19.5	Yes	Solder-Clamp
		9401-1083-109	-	9401-7083-109	1	11.2	No	Solder type
		9401-1583-109	-	9401-7583-109			Yes / For one-step cable assembly	
		9301-1063-009	-	9301-7063-009		8.4	N/A	Without center contact

## STRAIGHT PLUGS CRIMP TYPE FOR SEMI-RIGID CABLES

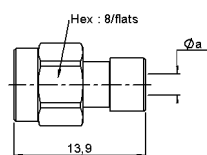

Fig. 1

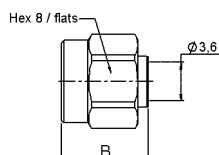

Fig. 2

Cable group	Cable group dia.	Part number (gold/passivated coupling nut)	Fig.	Dimensions A (mm)		Captive center contact	Note
				Ø a	B		
RG405	.085"	R125 052 901	1	2.2	-	Yes	-
RG402	.141"	R125 053 901	2	-	8.25	N/A	Retractable coupling nut
		R125 054 901	2	-	9.7	N/A	Without center contact
		R125 055 901	1	3.64	-	Yes	-



Right Angle Plugs

RIGHT ANGLE PLUGS FOR FLEXIBLE CABLES

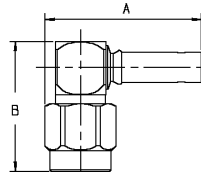

Fig. 1

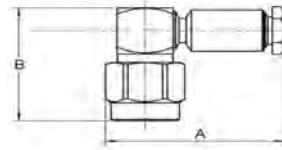

Fig. 2

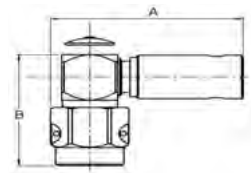

Fig. 3

Cable group	Cable group dia.	Part number (Gold)	Part number (Passivated)	Fig.	Dimensions (mm)		Captive center contact	Assembly type	Note			
					A	B						
RG178 / RG196	2/50/S	R125 170 402	-	1	19.6	16.85	Yes	Crimp	Incl. heatshrink tube			
Special	2.2/50/D	-	R125 163 200	2	20.2	16.4		Clamp	-			
RG174 / RG316	2.6/50/S	R125 172 000	R125 172 001	1	19.6			Crimp	Incl. heatshrink tube			
RD316	2.6/50/D	R125 174 000	-	1	18.6							
RG58 / RG141	5/50/S	R125 175 000	R125 175 001	2	21.8							
		R125 176 000	R125 176 001	2								
RG142 / RG223 / RG400	5/50/D	R125 176 505	-	3							Lock wire hole nut Incl. heatshrink tube	
RG178 / RG196	2/50/S	9043-1523-002	9043-9523-002	1	19.3					17	Crimp	-
		9243-1553-002	9243-9553-002	2	18.8						Clamp	-
		9043-1533-002	-	1	19.3						Solder	-
RD178	2/50/D	9043-1523-005	9043-9523-005	1	19.3		Crimp				-	
		9243-1553-005	9243-9553-005	2	18.8	Clamp	-					
		9043-1533-005	-	1	19.3	Solder	-					
RG174 / RG316	2.6/50/S	90431523-003	9043-9523-003	1	19.3	Crimp	-					
		9243-1553-003	9243-9553-003	2	18.8	Clamp	-					
		9043-1533-003	-	1	19.3	Solder	-					
RD316	2.6/50/D	9043-1523-019	9043-9523-019	1	19.3	Crimp	-					
		9243-1553-019	9243-9553-019	2	18.8	Clamp	-					
		9043-1533-019	-	1	19.3	Solder	-					
RG58 / RG141	5/50/S	9043-1523-006	9043-9523-006	1	19.3	Crimp	-					
		9243-1553-006	9243-9553-006	2	18.8	Clamp	-					
		9043-1533-006	-	1	19.3	Solder	-					
RG142 / RG223 / RG400	5/50/D	9243-1553-001	9243-9553-001	2	18.8	Clamp	-					
		9043-1533-001	-	1	19.3	Solder	-					
		9043-1523-001	9043-9523-001	1	19.3	Crimp	-					

Right Angle Plugs

RIGHT ANGLE PLUGS FOR SEMI-RIGID CABLES

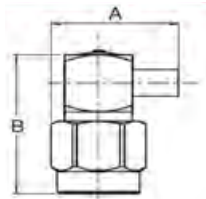
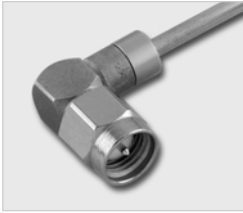

Fig. 1

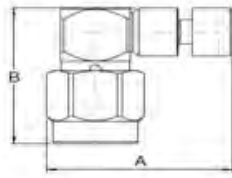

Fig. 2

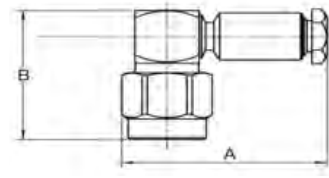

Fig. 3

Cable group	Cable group dia.	Part number (gold)	Part number (gold/passivated nut)	Fig.	Dimensions A (mm)	Dimensions B (mm)	Captive center contact	Assembly type
RG405	.085"	R125 153 000	R125 153 002	1	11.9	16.3	Yes	Solder type
RG402	.141"	R125 154 000	R125 154 002					
RG405	.085"	-	R125 153 901	2	15.7	15.8		Crimp type
RG402	.141"	-	R125 154 901					
RG405	.085"	9443-1563-010	-	1	12.2	17		Solder type
RG402	.141"	9443-1563-009	-					
RG405	.085"	9543-1593-010	9543-9593-010	3	18.8	17.5	Solder - Clamp	
RG402	.141"	9543-1593-009	9543-9593-009					

Straight Jacks

STRAIGHT JACKS FOR FLEXIBLE CABLES

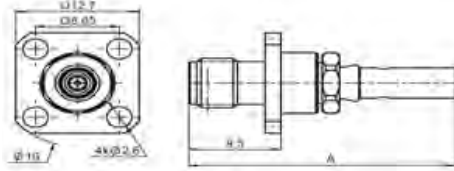

Fig. 1

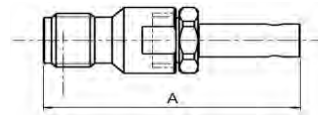

Fig. 2

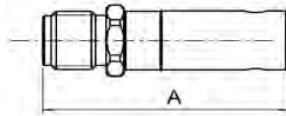

Fig. 3

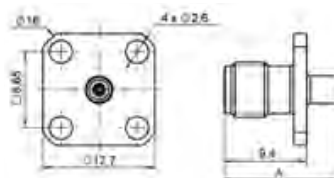

Fig. 4

Cable group	Cable group dia.	Part number (Gold)	Part number (Passivated)	Fig.	Dimensions A (mm)	Captive center contact	Panel drilling	Note
RG174 / RG316	2.6/50/S	R125 236 000	-	2	25.05	Yes	-	Crimp or solder
		R125 272 000	-	1	27.5		P03	Square flange
RG58 / RG141	5/50/S	R125 237 000	-	3	23.1	No	-	-
		R125 277 000	-	1	28.9		P03	Square flange
RG142 / RG223 / RG400	5/50/D	R125 238 000	-	3	23.1		-	-

## Straight Jacks

## STRAIGHT JACKS FOR FLEXIBLE CABLES (CONT'D)

Cable group	Cable group dia.	Part number (Gold)	Part number (Passivated)	Fig.	Dimensions A (mm)	Captive center contact	Panel drilling	Note
RG178 / RG196	2/50S	9002-1023-002	9002-9023-002	3	20.3	No	-	Crimp type
		9002-1033-002	-		20.3		-	Solder type
		9102-1573-002	9102-9573-002	2	27.9	Yes	-	Crimp type
		9031-1023-002	9031-9023-002	4	21	No	P03	Crimp type - Square flange
		9031-1033-002	-		21			Solder type - Square flange
		9131-1573-002	9131-9573-002	1	27.4	Yes		Crimp type - Square flange
RD178	2/50/D	9002-1023-005	9002-9023-005	3	20.3	No	-	Crimp type
		9002-1033-005	-				20.3	-
		9102-1573-005	9102-9573-005	2	27.9	Yes	-	Crimp type
		9031-1023-005	9031-9023-005	4	21	No	P03	Crimp type - Square flange
		9031-1033-005	-		21			Solder type - Square flange
		9131-1573-005	9131-9573-005	1	27.4	Yes		Crimp type - Square flange
RG174 / RG316	2.6/50S	9002-1023-003	9002-9023-003	3	20.3	No	-	Crimp type
		9002-1033-003	-				20.3	-
		9102-1573-003	9102-9573-003	2	27.9	Yes	-	Crimp type
		9031-1023-003	9031-9023-003	4	21	No	P03	Crimp type - Square flange
		9031-1033-003	-		21			Solder type - Square flange
		9131-1573-003	9131-9573-003	1	27.4	Yes		Crimp type - Square flange
RD316	2.6/50D	9002-1023-019	9002-9023-019	3	20.3	No	-	Crimp type
		9002-1033-019	-				20.3	-
		9102-1573-019	9102-9573-019	2	27.9	Yes	-	Crimp type
		9031-1023-019	9031-9023-019	4	21	No	P03	Crimp type - Square flange
		9031-1033-019	-		21			Solder type - Square flange
		9131-1573-019	9131-9573-019	1	27.4	Yes		Crimp type - Square flange
RG58 / RG141	5/50S	9002-1023-006	9002-9023-006	3	20.3	No	-	Crimp type
		9102-1573-006	9102-9573-006	2	27.9	Yes	-	Crimp type
		9002-1033-006	-	3	20.3	No	-	Solder type
		9031-1023-006	9031-9023-006	4	21		-	Crimp type - Square flange
		9031-1033-006	-			21	-	Solder type - Square flange
		9131-1573-006	9131-9573-006	1	27.4	Yes	-	Crimp type - Square flange
RG142 / RG223 / RG400	5/50D	9002-1033-001	-	3	20.3	No	-	Solder type
		9102-1573-001	9102-9573-001	2	27.9	Yes	-	Crimp type
		9031-1023-001	9031-9023-001	4	21	No	P03	Crimp type - Square flange
		9031-1033-001	-		21			Solder type - Square flange
		9131-1573-001	9131-9573-001	1	27.4	Yes		Crimp type - Square flange
		9002-1023-001	9002-9023-001	3	20.3	No	-	Crimp type

Straight Jacks

STRAIGHT JACKS FOR SEMI-RIGID CABLES

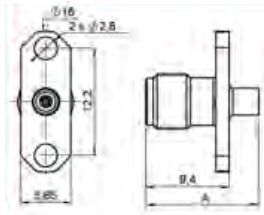

Fig. 1

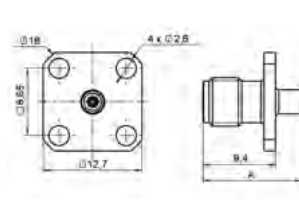

Fig. 2

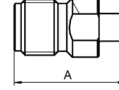

Fig. 3

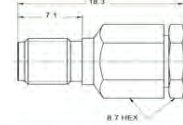

Fig. 4

Cable group	Cable group dia.	Part number (Gold)	Part number (Passivated)	Part number (Nickel)	Fig.	Dimensions	Captive center contact	Panel drilling	Note
						A (mm)			
RG405	.085"	R125 222 000	-	-	3	12.7	No	-	-
		R125 252 000	-	-	1			P02	2 hole flange
		R125 256 000	-	-	2			P03	Square flange
RG402	.141"	R125 225 000	-	-	3	12.7	No	-	-
		R125 251 000	-	-	1			P02	2 hole flange
		R125 255 000	-	-	2			P03	Square flange
RG405	.085"	9402-1083-010	-	9402-7083-010	3	15.2	Yes	-	Solder type
		9402-1583-010	-	9402-7583-010		12.7	No	-	
		9431-1083-010	-	9431-7083-010	2	13.9	No	P03	
		9431-1583-010	-	9431-7583-010			Yes / For one-step cable assembly		
		9441-1083-010	-	9441-7083-010	1	13.9	No	P02	
		9441-1583-010	-	9441-7583-010			Yes / For one-step cable assembly		
9502-1593-010	9502-9593-010	-	4	-	Yes	-	Solder - Clamp type		
RG402	.141"	9402-1083-009	-	9402-7083-009	3	12.7	No	-	Solder type
		9402-1583-009	-	9402-7583-009			Yes / For one-step cable assembly		
		9431-1083-009	-	9431-7083-009	2	13.9	No	P03	
		9431-1583-009	-	9431-7583-009			Yes / For one-step cable assembly		
		9441-1083-009	-	9441-7083-009	1	13.9	No	P02	
		9441-1583-009	-	9441-7583-009			Yes / For one-step cable assembly		
9502-1593-009	9502-9593-009	-	4	-	Yes	-	Solder - Clamp type		

Bulkhead Jacks

STRAIGHT BULKHEAD JACKS FOR FLEXIBLE CABLES (rear mount)

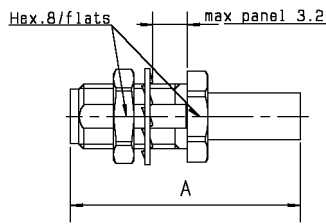

Fig. 1

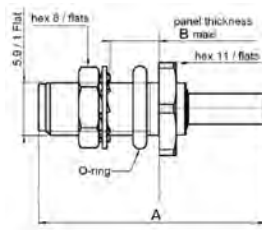

Fig. 2

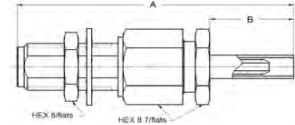
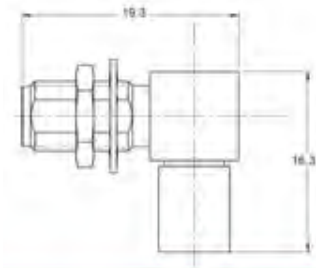

Fig. 3

Cable group	Cable group dia.	Part number (Gold)	Part number (Passivated)	Fig.	Dimensions (mm)		Captive center contact	Panel drilling	Note
					A	B			
RG178 / RG196	2/50/S	R125 320 020	-	2	26.1	5.6			Totally waterproof
RG174 / RG316	2.6/50/S	R125 303 000	R125 303 001	1	25.7	-			Crimp and solder Heatshrink sleeve
		R125 312 120	-	2	22.4	-			Full crimp
		R125 321 020	-	2	23.7	3.2			Totally waterproof
RD316	2.6/50/D	R125 313 120	-	1	22.4	-	Yes		Full crimp
		R125 322 030	-	2	-	3.2			Panel sealed
RG58 / RG141	5/50/S	R125 314 120	-	1	25.4	-			Full crimp
RG142 / RG223 / RG400	5/50/D	R125 315 120	-	1	-	-			
		R125 308 000	-	1	29.6	-			Crimp and solder
RG178 / RG196	2/50/S	9030-1023-002	9030-9023-002		23.9	-	No		Crimp type
		9030-1033-002	-		-	-			Solder type
		9130-1573-002	9130-9573-002	3	30.5	9.5	Yes		Crimp type
		9230-1553-002	9230-9553-002	3	21	0	Yes		Clamp type
RD178	2/50/D	9030-1023-005	9030-9023-005	1	23.9	-	No	P06	Crimp type
		9030-1033-005	-		-	-			Solder type
		9130-1573-005	9130-9573-005	3	30.5	9.5	Yes		Crimp type
		9230-1553-005	9230-9553-005	3	21	0	Yes		Clamp type
RG174 / RG316	2.6/50/S	9030-1023-003	9030-9023-003	1	23.9	-	No		Crimp type
		9030-1033-003	-		-	-			Solder type
		9130-1573-003	9130-9573-003	3	30.5	9.5	Yes		Crimp type
		9230-1553-003	9230-9553-003	3	21	0	Yes		Clamp type
RD316	2.6/50/D	9030-1023-019	9030-9023-019	1	23.9	-	No		Crimp type
		9030-1033-019	-		-	-			Solder type
		9130-1573-019	9130-9573-019	3	30.5	9.5	Yes		Crimp type
		9230-1553-019	9230-9553-019	3	21	0	Yes		Clamp type
RG58 / RG141	5/50/S	9030-1023-006	9030-9023-006	1	23.9	-	No		Crimp type
		9030-1033-006	-		-	-			Solder type
		9130-1573-006	9130-9573-006	3	30.5	9.5	Yes		Crimp type
		9230-1553-006	9230-9553-006	3	21	0	Yes		Clamp type
RG142 / RG223 / RG400	5/50/D	9030-1023-001	9030-9023-001	1	23.9	-	No		Crimp type
		9030-1033-001	-		-	-			Solder type
		9130-1573-001	9130-9573-001	3	30.5	9.5	Yes		Crimp type
		9230-1553-001	9230-9553-001	3	21	0	Yes		Clamp type

**Bulkhead Jacks**

**RIGHT ANGLE BULKHEAD JACKS CRIMP TYPE FOR FLEXIBLE CABLES (rear mount)**



Cable group	Cable group dia.	Part number (Gold)	Part number (Passivated)	Captive center contact	Panel drilling	Note
RG178 / RG196	2/50S	9613-1523-002	9613-9523-002	Yes	P06	Crimp type
RD178	2/50D	9613-1523-005	9613-9523-005			
RG174 / RG316	2.6/50S	9613-1523-003	9613-9523-003			
RD316	2.6/50D	9613-1523-019	9613-9523-019			
RG58 / RG141	5/50S	9613-1523-006	9613-9523-006			
RG142 / RG223 / RG400	5/50D	9613-1523-001	9613-9523-001			

**BULKHEAD JACKS SOLDER TYPE FOR SEMI-RIGID CABLES (rear mount)**

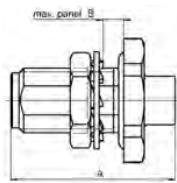
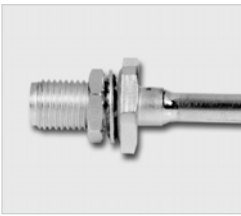

Fig. 1

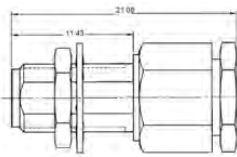

Fig. 2

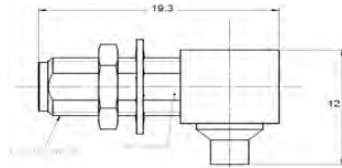

Fig. 3

Cable group	Cable group dia.	Part number (Gold)	Part number (Nickel)	Part number (Passivated)	Fig.	Dimensions A (mm)	Dimensions B (mm)	Captivecenter contact	Panel drilling	Note
RG405	.085"	R125 326 000	-	-	1	16	2.4	No	P06	Panel sealed
RG402	.141"	R125 325 000	-	-		17.1	3.5			Unsealed
		R125 305 000	-	-		17.8	3.2			Panel sealed
RG405	.085"	9453-1083-010	9453-7083-010	-	3	19.3		Yes	-	Solder type
		9613-1563-010	9613-9563-010	-	1	17.8		Yes / for one-step cable assembly	P06	Panel sealed
		9453-1583-010	9453-7583-010	-		Yes		Solder - Clamp		
		9530-1593-010	-	9530-9593-010	2	-		Yes / for one-step cable assembly	P06	Panel sealed
RG402	.141"	9453-1583-009	9453-7583-009	-	1	17.8		Yes		Solder - Clamp
		9530-1593-009	-	9530-9593-009	2	-	No	Panel sealed		
		9453-1083-009	9453-7083-009	-	1	17.8	Yes	-	Solder type	
		9613-1563-009	9613-9563-009	-	3	19.3	Yes	-	Solder type	

Receptacles

STRAIGHT FEMALE FLANGE RECEPTACLES - SOLDER POT

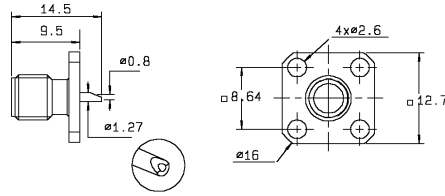

Fig. 1

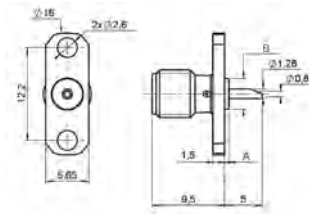

Fig. 2

Part number (Gold)	Part number (Passivated)	Fig.	Dimensions (mm)		Captive center contact	Panel drilling	Note
			A	B			
R125 403 000	R125 403 001	1	-	-	Yes (4 indents)	P04	Square flange
R125 453 000	-	2	0.6	$\phi 4.06$		Yes	P01
R125 454 000	R125 454 001		-	-			
9408-1113-000	9408-9113-000		0.8	-			
9408-1113-002	9408-9113-002	0	-		P02		

STRAIGHT AND RIGHT ANGLE FEMALE SQUARE FLANGE RECEPTACLES - SOLDER POT

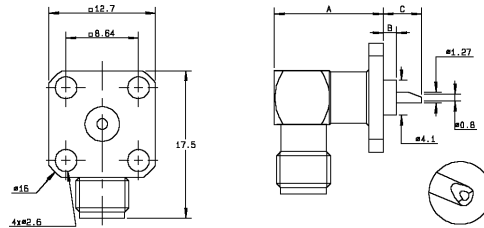

Fig. 1

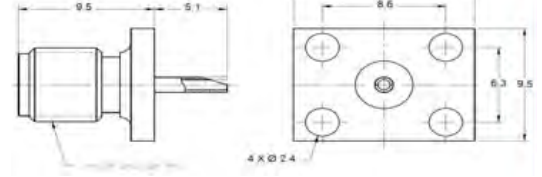

Fig. 2

Part number (Gold)	Part number (Passivated)	Fig.	Dimensions (mm)			Captive center contact	Panel drilling
			A	B	C		
-	R125 653 001	1	12.4	1.57	4.6	Yes	P04
R125 654 000	-		11.1	0	6.1		
9424-1513-000	9424-9513-000		12.7	1.6	4.8		P03
9425-1513-000	9425-9513-000		9.1				
9407-1113-000	9407-9113-000	2	-	-	-		

Receptacles

**BULKHEAD FEMALE RECEPTACLE (solder pot)**

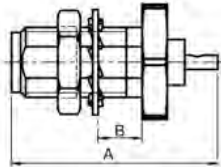

Fig. 1

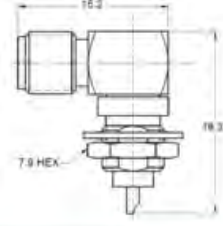

Fig. 2

Part number (Gold)	Part number (Passivated)	Fig.	Dimensions A (mm)	Dimensions B (mm)	Captive center contact	Panel drilling	Note
R125 553 000	R125 553 001	1	17.4	3.4	Yes (2 indents)	P06	Rear mount
9412-1113-000	9412-9113-000		17.0	3.2	Yes		-
9422-1113-000	9422-9113-000						Front mount
9432-1113-000	9432-9113-000						Rear mount, panel sealed
9609-1513-000	9609-9513-000	2	-	-		-	Right angle front mount

**SCREW-ON FEMALE RECEPTACLES (front mount)**

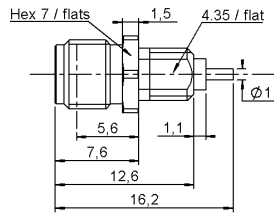

Fig. 1

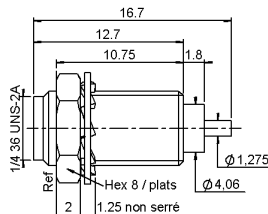

Fig. 2

Part number (gold)	Fig.	Captive center contact	Note
R125 555 500	1	Yes	Screw-on
R125 560 000	2		

**STRAIGHT MALE FLANGE RECEPTACLES (solder pot)**

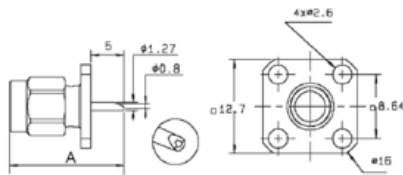

Fig. 1

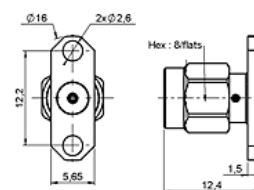

Fig. 2

Part number (Gold)	Fig.	Captive center contact	Dimensions A (mm)	Panel drilling	Note
R125 433 000	1	Yes (4 indents)	17.4	P04	Square flange
R125 483 000	2			P01	2 hole flange
9404-1113-000	1	Yes	14.5	P03	1/2" Square flange
9476-1113-000				P11	3/8" Square flange



Receptacles

**SQUARE FLANGE EXTENDED DIELECTRIC FEMALE RECEPTACLES**

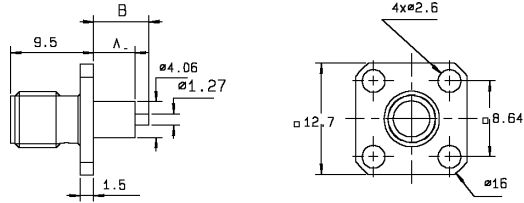

Part number (Gold)	Part number (Passivated)	Dimensions (mm)		Captive center contact	Panel drilling
		A	B		
R125 413 000	R125 413 001	12.7	15.9	No	P04
R125 414 000	R125 414 001			Yes (epoxy)	
R125 414 004	-			Yes (4 indents)	
R125 415 000	R125 415 001	18	20.5	Yes (epoxy)	
R125 415 030	-	3.2	5.4	Yes (4 indents)	
R125 415 275	-	15	17.9	Yes (4 indents)	
R125 415 270	R125 415 271			Yes (epoxy)	
R125 416 460	-	4	8	Yes (epoxy)	
9004-1113-000	9004-9113-000	14.9	3	Yes (4 indents)	P11
9004-1213-000	-			Yes (square flange)	
-	9076-9113-000			Yes (4 incidents)	
-	9007-9113-000			Yes (4 incidents)	

**2 HOLE FLANGE EXTENDED DIELECTRIC FEMALE RECEPTACLES**

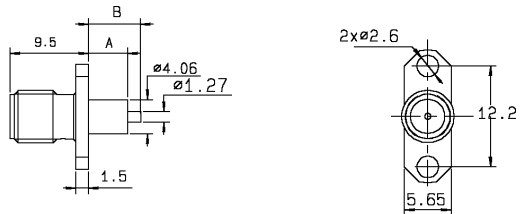

Part number (Gold)	Part number (Passivated)	Dimensions (mm)		Captive center contact	Panel drilling
		A	B		
R125 464 000	R125 464 001	12.7	15.9	Yes (epoxy)	P01
R125 464 270	R125 464 271	15	17.9	Yes (4 indents)	
R125 464 274	-	-	-	Yes (4 indents)	
9008-1113-000	-	14.98	24.32	No	
9008-1213-000	-			Yes (4 indents)	
-	9008-9113-000	-	-	Yes (4 indents)	

**RIGHT ANGLE FEMALE SQUARE FLANGE EXTENDED DIELECTRIC RECEPTACLES**

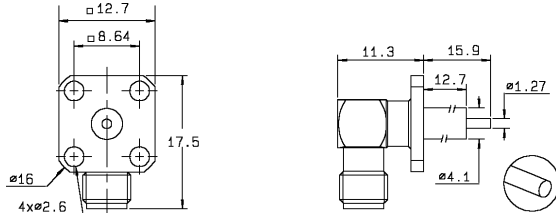
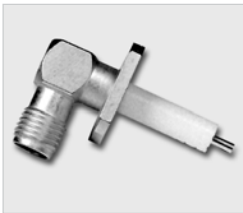

Part number (Gold)	Part number (Passivated)	Captive center contact	Panel drilling
R125 654 450	R125 654 451	Yes	P04

Receptacles

STRAIGHT MALE FLANGE EXTENDED DIELECTRIC RECEPTACLES

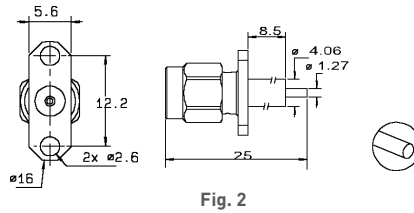
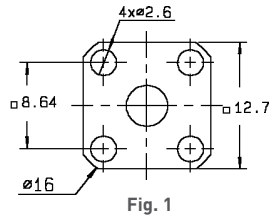
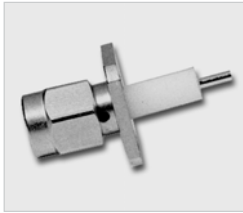

Part number (Gold)	Part number (Passivated)	Fig.	Captive center contact	Panel drilling	Note
R125 444 000	R125 444 001	1	Yes (epoxy)	P04	Square flange
R125 474 000	R125 474 001	2		P01	2 hole flange

PCB FEMALE RECEPTACLES

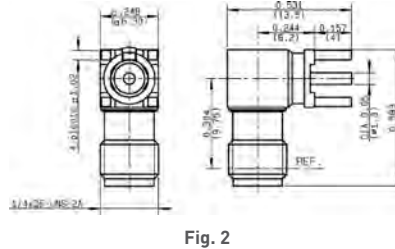
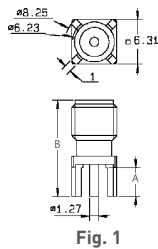

Part number (Gold)	Fig.	Dimensions (mm)		Captive center contact	PCB pattern	Note
		A	B			
R125 426 000	1	4	13.5	Yes	P05	-
R125 426 140		6.9	14.4			Selective tin plating
R125 680 000	2	-	-	-	-	-

STRAIGHT FEMALE SQUARE FLANGE RECEPTACLES - TAB CONTACT

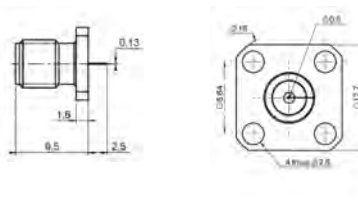
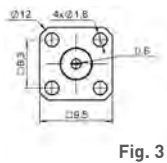
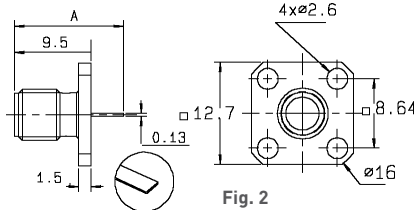
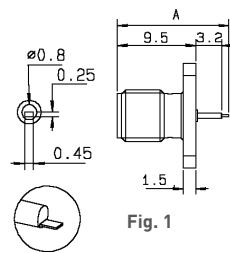

Fig. 4

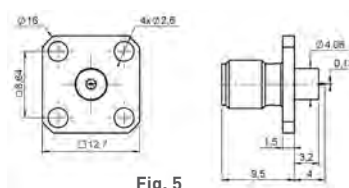

Fig. 5

Part number (Gold)	Part number (Passivated)	Fig.	Dimensions A (mm)	Captive center contact	Panel drilling	Contact type
R125 501 000	R125 501 001	1	13.5	Yes (epoxy)	P04	Offset tab
R125 510 000	R125 510 001	2	12		P11	Tab
R125 510 500	R125 510 501	3	2.5			
R125 612 120	-	4	-		P04	Tab
R125 620 000	-	2	10.38			
R125 622 000	-	5	-			
-	R125 943 001	3	0.89		P11	

Receptacles

**STRAIGHT AND RIGHT ANGLE FEMALE 2 HOLE FLANGE RECEPTACLES - TAB CONTACT**

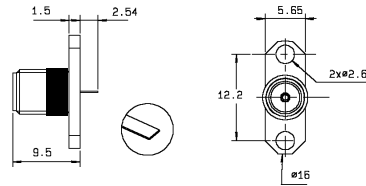

Fig. 1

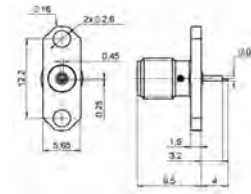

Fig. 2

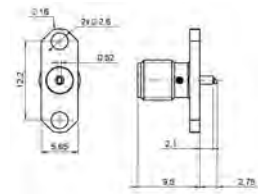

Fig. 3

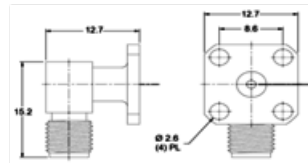

Fig. 4

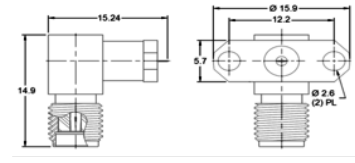
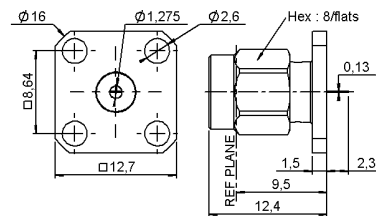

Fig. 5

Part number (Gold)	Part number (Passivated)	Fig.	Captive center contact	Panel drilling	Contact type
R125 451 000	-	2	Yes (epoxy)	P01	Offset tab
R125 452 000	-	3			Special
R125 497 000	-	1			Tab
9124-1513-000	9124-9513-000	4	Yes	P03	Tab contact 1.3mm width
9126-1513-000	9126-9513-000	5		P01	

**STRAIGHT MALE SQUARE FLANGE RECEPTACLES - TAB CONTACT**



Part number (Gold)	Part number (Passivated)	Captive center contact	Panel drilling	Note
R125 488 000	R125 488 001	Yes (epoxy)	P04	Unit packaging

**STRAIGHT FEMALE SQUARE FLANGE RECEPTACLES - CYLINDRICAL CONTACT**

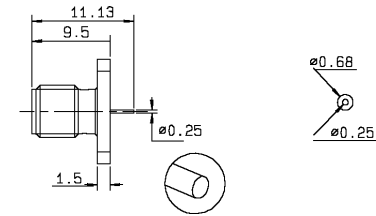
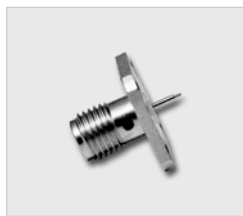

Part number (Gold)	Captive center contact	Panel drilling	Note
R125 610 000	Yes (epoxy)	P04	Unit packaging

Receptacles for Microstrip

STRAIGHT FEMALE FLANGE RECEPTACLES - CYLINDRICAL CONTACT

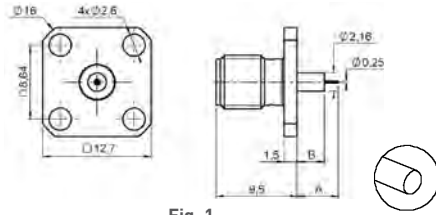

Fig. 1

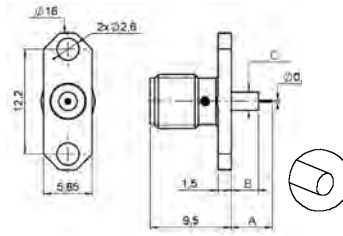

Fig. 2

Part number (Gold)	Part number (Passivated)	Fig.	Dimensions (mm)			Captive center contact	Panel drilling	Note	Captive center contact
			A	B	C				
R125 512 000	R125 512 001	1	4.8	3.2	-	Yes	P04	Square flange	4 indents
R125 513 000	-		3.2	1.6	-				Epoxy
R125 462 000	R125 462 001	2	4.8	3.2	2.16		P01	2 hole flange	Epoxy
R125 463 000	-		3.2	1.6	2.16				
-	R125 617 001		4.8	3.2	4.06				

STRAIGHT MALE FLANGE RECEPTACLES - CYLINDRICAL CONTACT

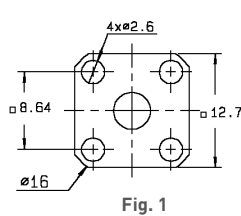

Fig. 1

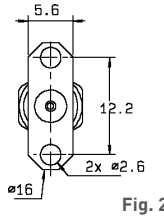
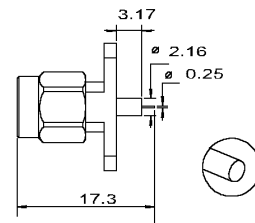

Fig. 2



Part number (Gold)	Part number (Passivated)	Fig.	Captive center contact	Panel drilling	Note
R125 492 000	R125 492 001	1	Yes (epoxy)	P04	Square flange
R125 484 000	R125 484 001	2		P01	2 hole flange

Receptacles for Microstrip

**UNIVERSAL FIELD-REPLACEABLE RECEPTACLES - FEMALE SOCKET**  
(accept pin 0.93 mm [.037"])

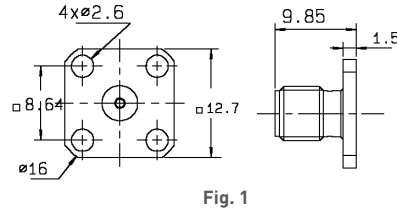
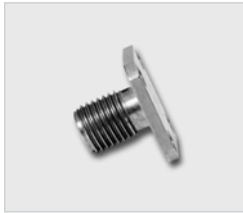

Fig. 1

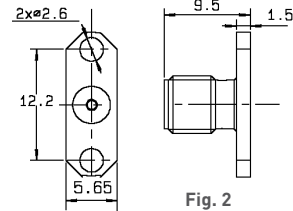

Fig. 2

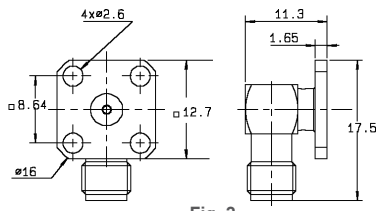

Fig. 3

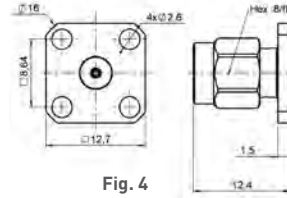

Fig. 4

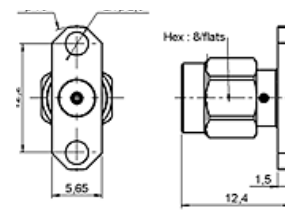

Fig. 5

Part number (Gold)	Part number (Passivated)	Fig.	Captive center contact	Panel drilling	Note
R125 410 000	R125 410 001	1	Yes (epoxy)	P04	Female - Square flange
-	R125 430 001	4			Male - Square flange
R125 460 000	R125 460 001	2		-	P01
-	R125 480 001	5	Male - 2 hole flange		
-	R125 670 001	3	-	P04	Female - Right angle square flange

**EDGE CARD RECEPTACLES**

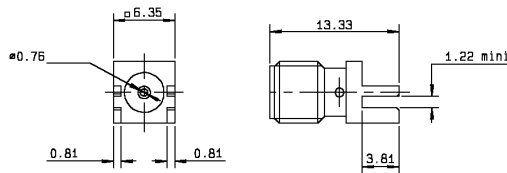
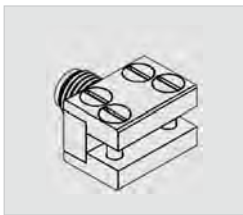

Fig. 1

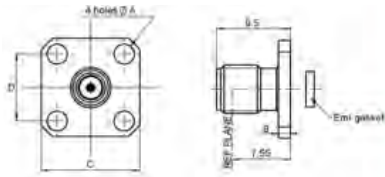
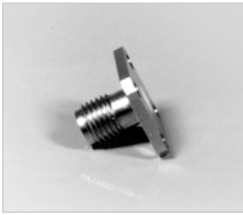

Fig. 2

Part number (Gold)	Part number (Passivated)	Fig.	Captive center contact	Note	Captivation
R125 423 200	-	1	Yes	Solder pins	4 indents
R125 541 000	R125 541 001	2		4 screws	Epoxy

Hermetic Receptacles with Separate Glass Bead

**SQUARE FLANGE 12.7 mm FEMALE RECEPTACLE**



Part number (Gold)	Part number (Passivated)	Glass bead only	Dimensions (mm)				EMI gasket only	Panel drilling connector	Panel drilling glass bead	Note
			A	B	C	D				
R125 411 000	R125 411 001	R280 751 000	2.6	1.5	12.7	8.6	R280 510 000	P10	P13	Diameter pin = 0.30
9074-9513-000	-	-	1.7	1.6	9.5	6.3	-			Diameter pin = 0.45
9079-9513-000	-	-	-	-	-	-	-			Diameter pin = 0.30
9079-9513-001	-	-	-	-	-	-	-			Diameter pin = 0.38

**NARROW FLANGE FEMALE RECEPTACLES**

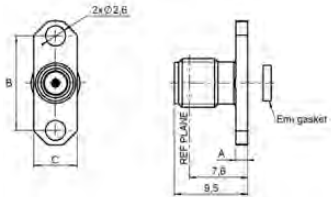

Part number (Gold plated)	Part number (Passivated)	Glass bead only	Dimensions (mm)			EMI gasket only	Panel drilling connector	Panel drilling glass bead	Note
			A	B	C				
R125 465 000	R125 465 001	R280 751 000	1.5	12.2	5.6	R280 510 000	P12	P13	-
R125 465 010	R125 465 011	R280 757 070					P18	-	-
-	9080-9513-000	920-55	1.6	10.2	4.7	No EMI gasket	-	-	Diameter Pin = 0.30
-	9180-9513-000	920-55 (included)					-	-	-
-	9180-9513-001	920-82 (included)					-	-	-
-	9144-9513-000	920-55 (included)	12.2	5.7	Contact Us	P12	-	-	Diameter Pin = 0.38

**NARROW FLANGE MALE RECEPTACLES**

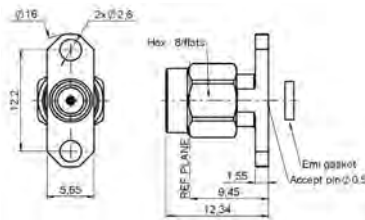

Part number (Passivated)	Glass bead only	EMI gasket only	Panel drilling connector	Panel drilling glass bead
R125 481 001	R280 751 000	R280 510 000	P12	P13
R125 481 011	R280 757 070			P18
9050-9513-000	920-56	Contact Us		-

Hermetic Receptacles with Integrated Glass Bead

SCREW-ON TYPE FEMALE RECEPTACLES

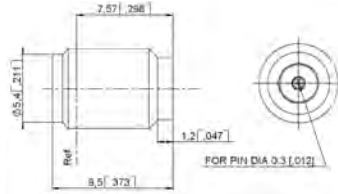

Fig. 1

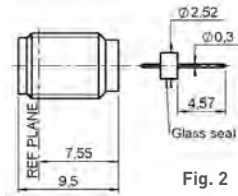
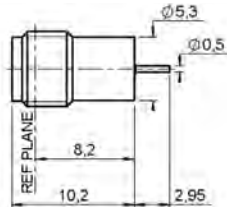

Fig. 2

Part number (Passivated)	Glass bead only	Fig.	Assembly tool	Panel drilling glass bead	Note
R125 556 001	R280 751 000	1	R282 341 010	P15	For pin dia 0.3/0.12
R125 556 011	R280 755 000			P19	For pin dia 0.5/0.19
R125 638 001	R280 751 350	2		P15	Supplied with glass bead

SOLDER TYPE FEMALE RECEPTACLE

Panel feedthrough receptacles feature an internal hermetic glass bead. A ring of solder between the receptacle body and the package will provide the hermeticity level.



Part number (Gold)	Connector body	Panel drilling	Contact type
R125 630 000	FN42 alloy	-	Cylindrical
R125 630 040	Stainless steel		

SCREW-ON TYPE FEMALE RECEPTACLE

Screw-on receptacles with integrated glass seal - the compression gasket will ensure the hermeticity between the receptacle and the package.

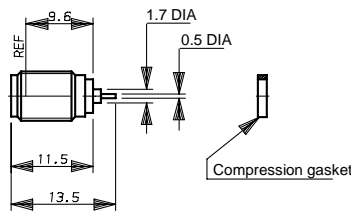

Part number (Gold)	Part number (Passivated)	Connector body	Panel drilling	Contact type
R125 609 000	R125 609 001	Stainless steel	P05	Cylindrical

SCREW-ON TYPE FEMALE RECEPTACLE WITH SLIDING CONTACT

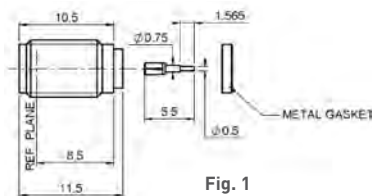
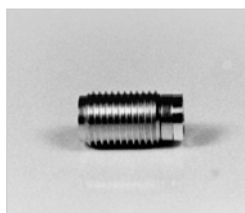

Fig. 1

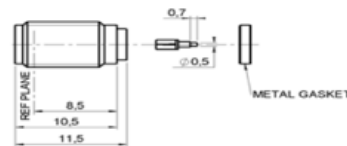

Fig. 2

Part number (Passivated)	Fig.	Connector body	Panel drilling	Contact type
R125 609 031	1	Stainless steel	P05	Cylindrical
R125 609 011	2			

Hermetic Receptacles without Glass Bead

SCREW-ON TYPE FEMALE RECEPTACLE WITH SLIDING CONTACT

Screw-on receptacles without glass bead provide a lower hermeticity level (10<sup>-6</sup>atm/cm<sup>3</sup>/sec). A gasket is provided to guarantee the hermeticity between the receptacle and the package.

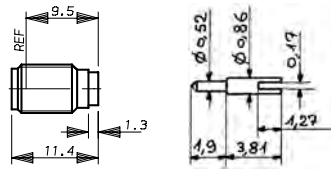

Part number (Gold)	Part number (Passivated)	Panel drilling	Contact type
R125 605 300	R125 605 301	P08	Slotted

Adapters

IN SERIES ADAPTERS

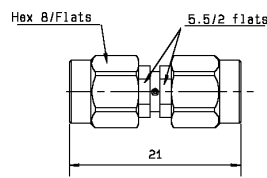

Fig. 1

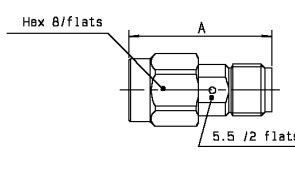

Fig. 2

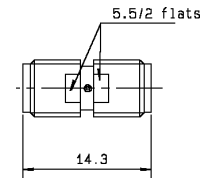

Fig. 3

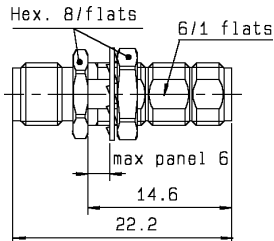

Fig. 4

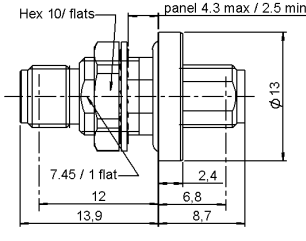

Fig. 5

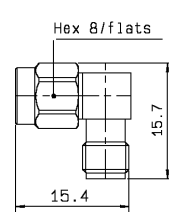

Fig. 6

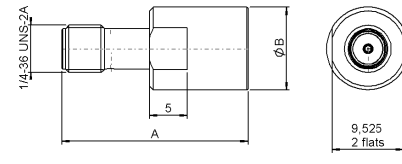

Fig. 7

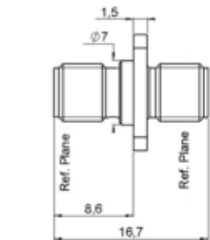

Fig. 8

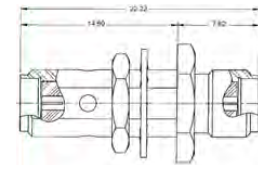

Fig. 9

Part number (Gold)	Part number (Passivated)	Fig.	Dimensions (mm)		Captive center contact	Panel drilling	Note
			A	B			
R125 703 000	R125 703 001	1	-	-	-	-	Male - Male
R125 704 000	R125 704 001	2	17.5	-	Yes (4 indents)	-	Male - Female
R125 705 000	R125 705 001	3	-	-	-	-	Female - Female
R125 720 000	R125 720 001	4	-	-	Yes (epoxy)	P06	Bulkhead female - Female
R125 753 000	R125 753 001	5	-	-	Yes	P08	Bulkhead hermetically sealed Female - Female
R125 771 000	R125 771 001	6	-	-	-	-	Right angle male - Female
-	R125 791 501	7	23.3	8.9	Yes (epoxy)	-	Push-on male
-	R125 792 501		24.8	11		P07	Push-on female
-	R125 710 021		-	-		P06	Female - Female square flange adapter
5909-1103-000	5909-9103-000	9	-	-	-	-	Bulkhead female - Female
5916-1103-603	5916-9103-603	2	17.4	-	-	-	Male - Female
5917-1103-000	5917-9103-000	3	-	-	-	-	Female - Female
5918-1103-000	5918-9103-000	1	-	-	Yes (4 indents)	-	Male - Male
5919-1503-000	5919-9503-000	6	-	-		-	Male - Female / Right angle
5919-1503-001	5919-9503-001		-	-		-	Male - Male / Right angle
5919-1503-003	5919-9503-003		-	-		-	Male - Male / Right angle



Adapters

TEE IN SERIES ADAPTERS

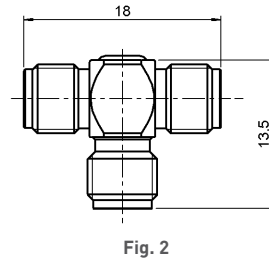
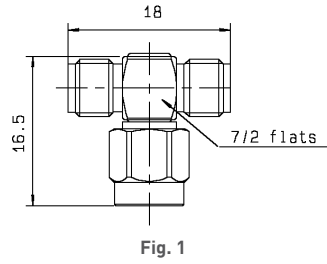

Part number (Gold)	Part number (Passivated)	Fig.	Type	Captive center contact
R125 780 000	R125 780 001	1	Male / Female - Female	Yes
R125 781 000	R125 781 001	2	Female / Female - Female	

Accessories

MALE AND FEMALE CAPS

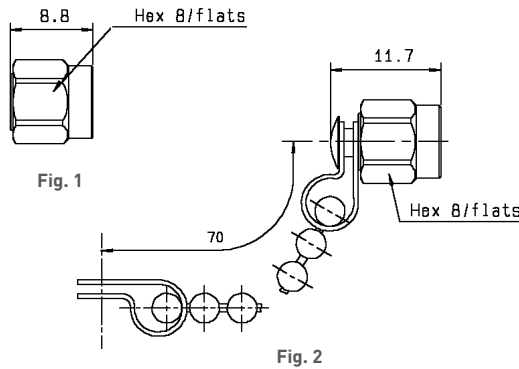

Part number (Gold)	Part number (Passivated)	Fig.	Note
R125 802 000	R125 802 001	1	Male
R125 812 000	R125 812 001	2	Male with chain
R125 852 000	R125 852 001	1	Male short circuit
R125 845 000	R125 845 001	3	Female with cord

CENTER CONTACTS (To be used with universal receptacle)

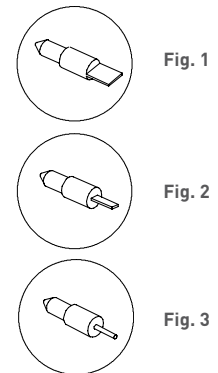
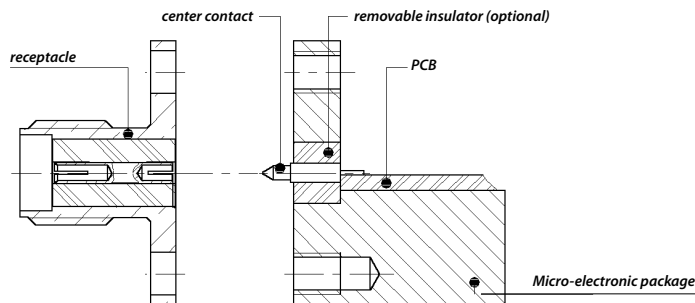

Part number	Fig.	Termination	Dimensions (mm)			Packaging
			A	B	C	
R280 461 000	1	Tab	3.37	0.13	1.6	10 pieces
R280 461 200	2	Tab special	3.37	0.13 x W0.51	1.6	
R280 461 210	1	Tab	10.3	0.13	1.6	
R280 462 000	3	Cylindrical	1.77	dia 0.25	1.57	
R280 463 000	3	Cylindrical	3.37	dia 0.25	1.57	
R280 465 000	2	Tab special	0.2	0.13 x W0.60	0.9	

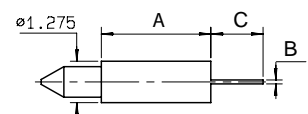

Glass Beads

GLASS BEADS FOR HERMETIC RECEPTACLES

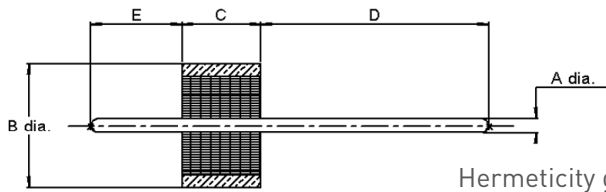
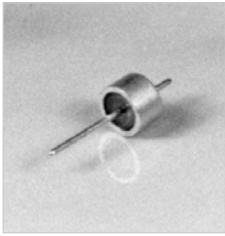

Hermeticity guaranteed at  $10^{-8}$  atm.cm<sup>3</sup>/s

Part number	Dimensions mm (inch)					Packaging
	A	B	C	D	E	
R280 751 000	0.30 (.012)	2.52 (.099)	1.60 (.063)	4.57 (.180)	1.83 (.072)	1
R280 751 080				1.3 (.051)		100
R280 751 350				4.57 (.180)		1
R280 752 000	0.38 (.015)	2.50 (.098)	1.56 (.061)	1.95 (.076)	1.59 (.062)	100
R280 752 020				1.3 (.051)		
R280 755 000	0.46 (.018)	2.85 (.112)	1.60 (.063)	4.57 (.180)	-	1
R280 755 040		2.85 (.111)				
R280 757 070	0.50 (.019)	4 (.157)	1.77 (.070)	1.78 (.070)	2.03 (.080)	100
R280 757 080				5.82 (.230)	1.93 (.076)	1

Go to page 17-18 for more glass beads.

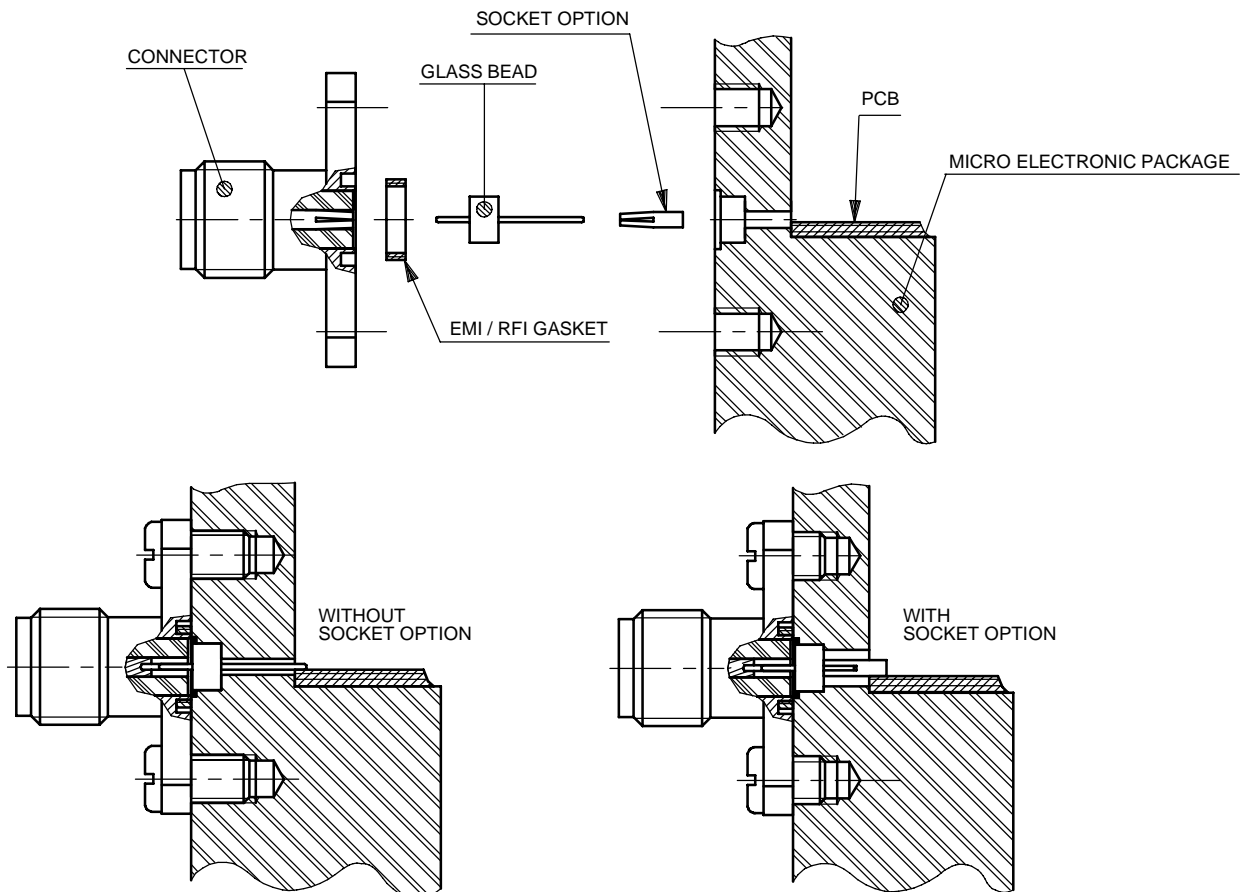

## Accessories for Hermetic Microstrip Receptacles

### OPTIONAL SOCKET

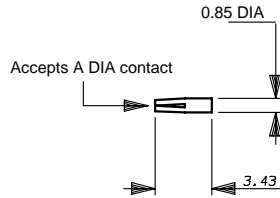

Part number	A Dia (mm)	Packaging
R280 469 000	0.30	10 pieces
R280 469 010	0.46	

Go to chapter 19-A for more socket contact options.

For use with glass seal.

### Panel Drilling

#### P01

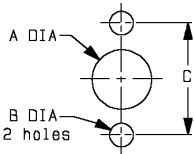

	MM		INCH	
	maxi	mini	maxi	mini
A	4.2	4.1	0.165	0.161
B	2.7	2.6	0.106	0.102
C	12.25	12.15	0.482	0.478

#### P02

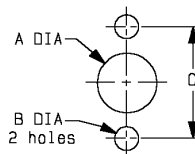

	MM		INCH	
	maxi	mini	maxi	mini
A	6.6	6.5	0.26	0.256
B	2.7	2.6	0.106	0.102
C	12.25	12.15	0.482	0.478

#### P03

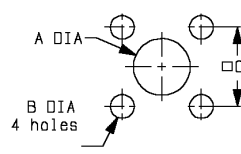

	MM		INCH	
	maxi	mini	maxi	mini
A	6.6	6.5	0.26	0.256
B	2.7	2.6	0.106	0.102
C	8.69	8.59	0.342	0.338

#### P04

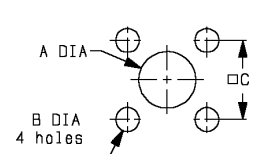

	MM		INCH	
	maxi	mini	maxi	mini
A	4.3	4.2	0.169	0.165
B	2.7	2.6	0.106	0.102
C	8.69	8.59	0.342	0.338

#### P05

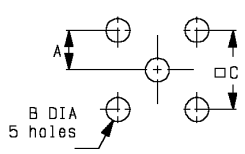

	MM		INCH	
	maxi	mini	maxi	mini
A	2.59	2.49	0.102	0.098
B	1.7	1.6	0.067	0.063
C	5.13	5.03	0.202	0.198

#### P06

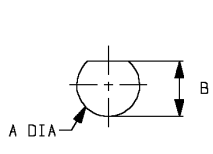

	MM		INCH	
	maxi	mini	maxi	mini
A	6.5	6.4	0.256	0.252
B	6.14	6	0.242	0.236

#### P07

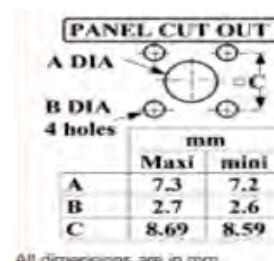

All dimensions are in mm.

#### P08

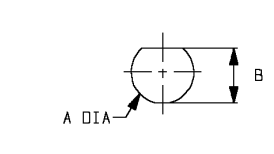

	MM		INCH	
	maxi	mini	maxi	mini
A	8.1	8	0.319	0.315
B	7.6	7.5	0.299	0.295

#### P09

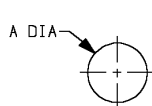

	MM		INCH	
	maxi	mini	maxi	mini
A	5.2	5.16	0.205	0.203

#### P10

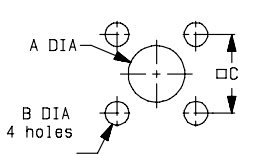

	MM		INCH	
	maxi	mini	maxi	mini
A	4.2	4.1	0.165	0.161
B	2.7	2.6	0.106	0.102
C	8.69	8.59	0.342	0.338

#### P11

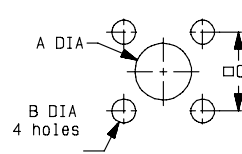

	MM		INCH	
	maxi	mini	maxi	mini
A	4.2	4.1	0.165	0.161
B	1.9	1.8	0.071	0.067
C	6.4	6.3	0.252	0.248

#### P12

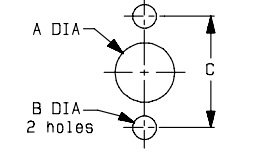

	MM		INCH	
	maxi	mini	maxi	mini
A	4.2	4.1	0.165	0.161
B	2.7	2.6	0.106	0.102
C	12.25	12.15	0.482	0.478

Panel Drilling

HERMETIC SEPARATE GLASS BEAD RECEPTACLES

P13/14

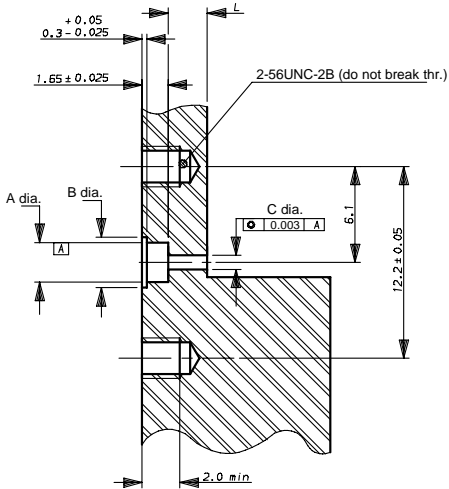

	P13	P14
A dia.	2.6±0.025	2.92±0.025
B dia.	3.23±0.025	3.55±0.025
C dia. (1)	2±0.02	
C dia. (2)	0.7±0.02	1.08±0.02
L dia. (1)	2.5±0.1	
L dia. (2)	from 1 mm to 4 mm	

- (1) Using of the removable contact.
- (2) The pin is directly welded on the trace.

P15/16

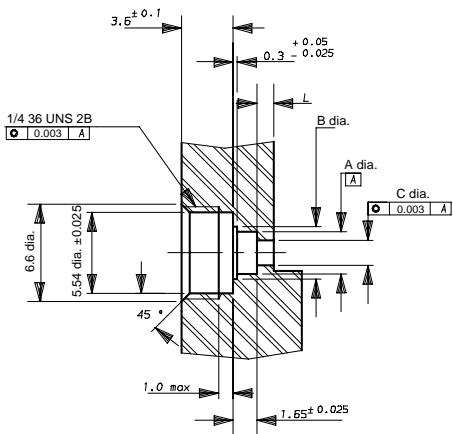

	P15	P16
A dia.	2.6±0.025	2.92±0.025
B dia.	3.23±0.025	3.55±0.025
C dia. (1)	2±0.02	
C dia. (2)	0.7±0.02	1.08±0.02
L dia. (1)	2.5±0.1	
L dia. (2)	from 1 mm to 4 mm	

- (1) Using of the removable contact.
- (2) The pin is directly welded on the trace.

P17

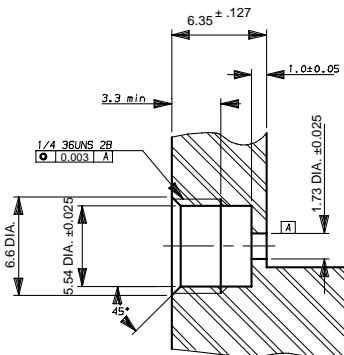

P18

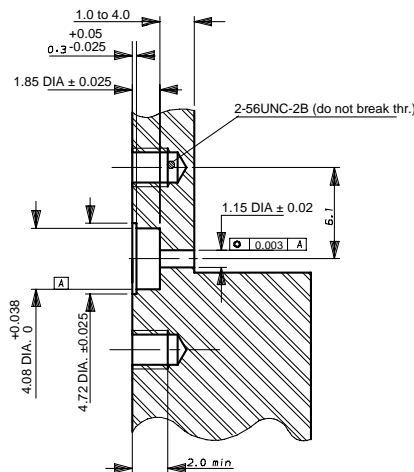

## Panel Drilling

### HERMETIC SEPARATE GLASS BEAD RECEPTACLES

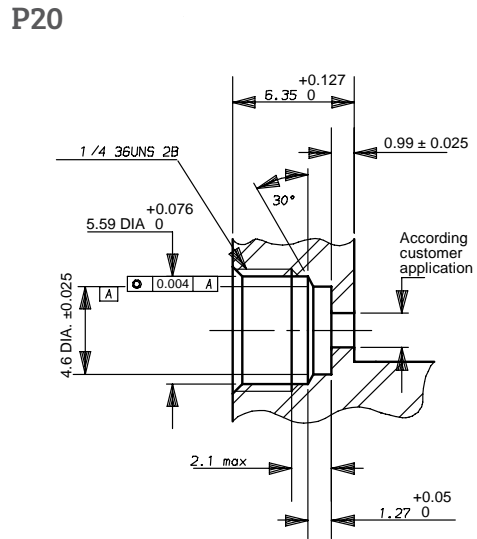
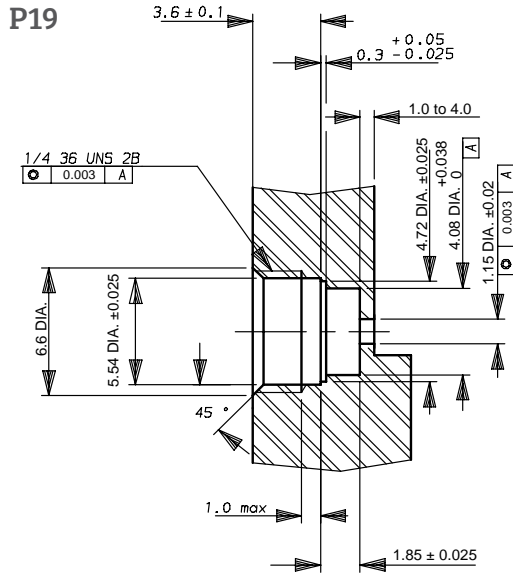

### Tooling for Hermetic Receptacles

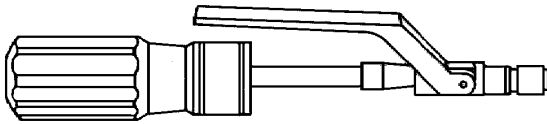

Coupling torque: 190 cm N

Part number	Description
R282 341 010	Installation tool for jack receptacles R125 556 000 R125 556 001 R125 556 010 R125 556 011

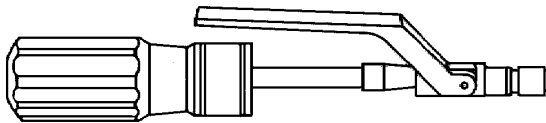

Coupling torque: 280 cm N

Part number	Description
R282 341 012	Installation tool for jack receptacles R125 605 361 R125 605 371 R125 605 401 R125 609 000 R125 609 001 R125 609 010 R125 609 011 R125 609 070 R125 609 071

## Field Replaceable Hermetic Microstrip Receptacle Information

## ELECTRICAL PERFORMANCE

## V.S.W.R. to 18 GHz

Connector only	Seal only	Connector & seal
1.04 + 0.006F (GHz)	1.02 + 0.003F (GHz)	1.06 + 0.01F (GHz)

## V.S.W.R. MEASUREMENT

## Setting for V.S.W.R. measurement on field replaceable hermetic receptacle

## a) Measurement with auxiliary contact-assembly drawing

R280 469 000 (for pin DIA 0.30 mm)  
R280 469 010 (for pin DIA 0.46 mm)

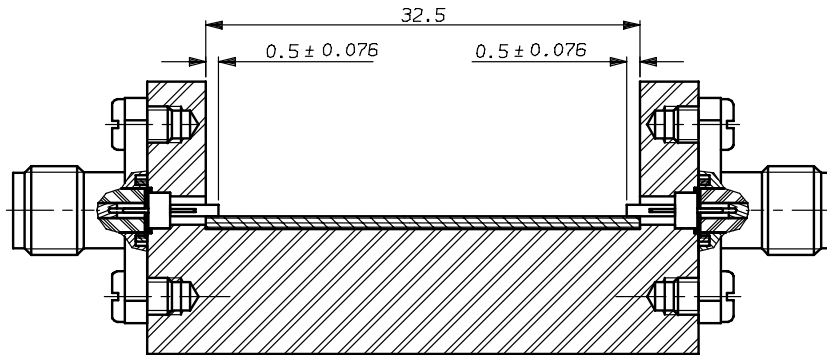

## b) Measurement without auxiliary contact-assembly drawing

Recommended value : L1 = 1.0 mm

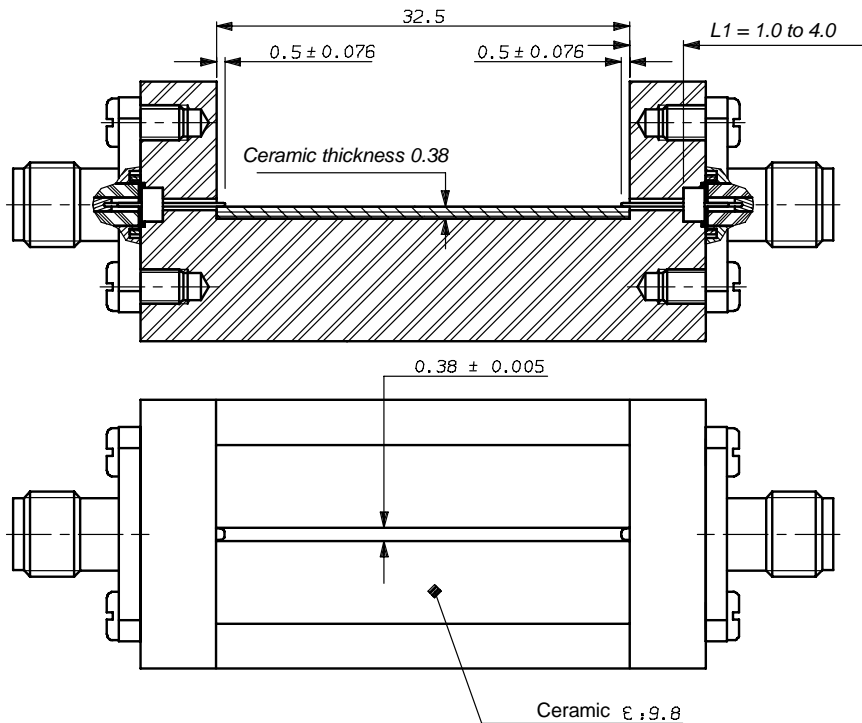

The track width on ceramic defines the circuit impedance.

## Field Replaceable Hermetic Microstrip Receptacle Information

## GLASS BEAD AND CONNECTOR ASSEMBLY INTO THE MICRO ELECTRONIC PACKAGE

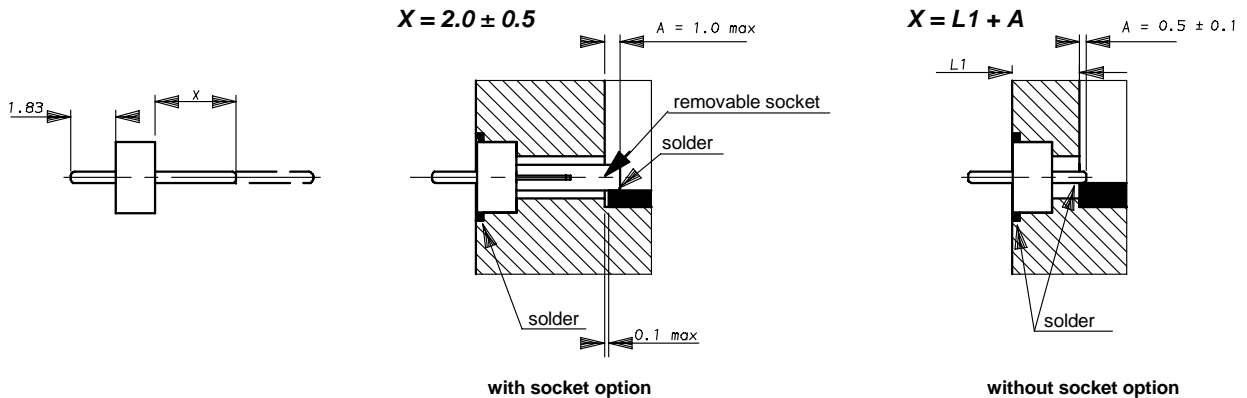
**GLASS BEAD**

1. Adjust X by cutting the pin if necessary
2. Introduce the glass bead into its cavity
3. Place a ring of solder in the groove around the glass bead (a 0.3 mm wire dia. of solder is recommended)
4. Solder the pin (or optional socket) on the PCB trace inside the package

Note: there is not too much welding.

**IMPORTANT:** For maximum RF performance, the link track/pin must be as thin as possible.

Therefore, we advise to follow the A dimension rigorously, by soldering accurately the pin or the socket directly on the trace.

**CONNECTOR RECEPTACLE**

Place the "EMI" screening gasket in the groove of the receptacle (if applicable).

Introduce gently the receptacle on the glass bead pin, then screw the flange (use the appropriated tool for screw-in receptacle).

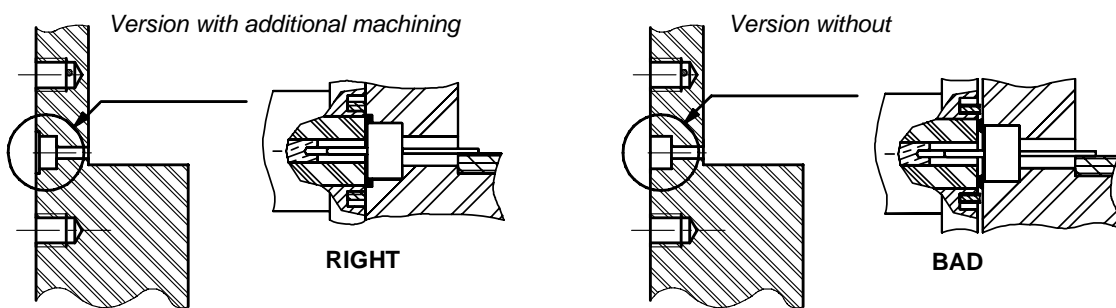
**GLASS BEAD MOUNTING**

The Radiall panel drilling on page 8-27 recommends an additional bore or chamfer machining on the outer edge of the glass bead housing. This additional machining allows to place a pre-form (solder stick Dia. 0.3 mm) before soldering.

After mounting, solder is flush and allows the right positioning of the receptacle.

The EMI gasket efficiency is guaranteed.

## Introduction

Radiall Commercial SMA connectors are specially designed for applications where low installation cost are most important. They are easy, fast to assemble and reliable, and offer the perfect solution for high volume applications requiring high level performance such as in civil telecommunications, data communications or test and measurement.

- **Full compatibility:**

Commercial SMA connectors are fully compatible (interchangeable and intermateable) with all existing MIL standardized SMA connectors. They feature the same performance level except for mechanical characteristics (life: 100 matings and coupling nut torque: 60 Ncm).

The coupling nut of Commercial SMA connectors features a special design which is different from the standard SMA coupling nut as the tightening torque is reduced.

- **Wide range:**

The Commercial SMA series offers a wide range of solutions which are for every standard coaxial flexible or semi-rigid cable as well as PCB models with traditional through-hole pins or solder pads for SMT applications.

- **Simple snap-in axial captivation (for full crimp models):**

The relative position of the center contact into the interface is mechanically guaranteed by the snapping of the insulator inner shoulder into the groove of the center contact.

This design facilitates the captivation operation in contrast to other designs, requiring two insulators to provide contact retention. It assures constant and perfect axial positioning of the center contact into the interface.

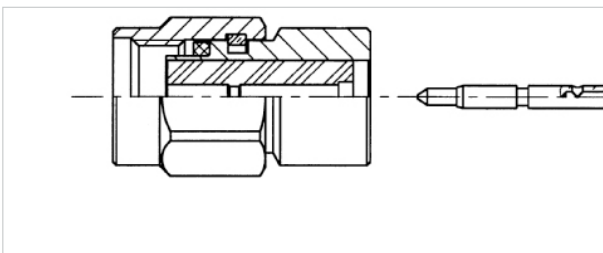

- **Space-saving size:**

Due to the captivation technique, these commercial SMA connectors are shorter than multi-piece body connectors.

- **Convenient 3-piece design:**

- For straight models: body + center contact + outer ferrule
- For right angle models: single piece body + back cap + outer ferrule

- **Fast and reliable cable attachment:**

The cable connectors can be either fully crimped or soldered/crimped, offering full flexibility for high volume industrial production with standard manual or pneumatic tooling: fast and reliable

- The center contact can be either crimped or soldered
- The outer contact is attached to the cable by crimping a ferrule

- **Competitive pricing:**

The design and materials used in the manufacturing of the Commercial SMA series allow us to offer connectors at competitive prices to suit a wide range of applications. The connector body is manufactured in brass and the surface plating is available in either gold or in BBR finish (Radiall non-magnetic bright bronze surface finish).

- **Center contact captivation:**

Our connectors have a captive center contact.



Introduction

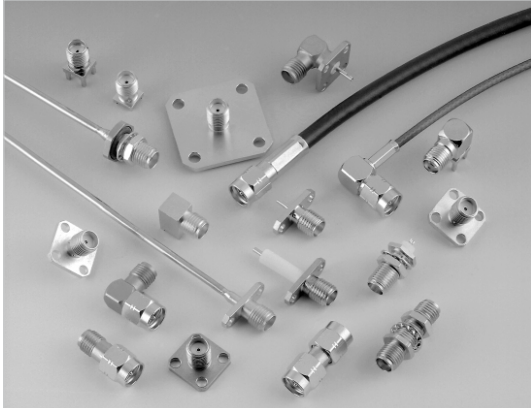

50Ω

DC - 18 GHz

**GENERAL**

- Subminiature coaxial connectors
- Screw-on coupling
- High RF performance
- 2 plating options:
  - BBR
  - Gold

**APPLICABLE STANDARDS**

- MIL-C-39012
- IEC 169-1
- CECC 22110
- CECC 22111 - 801 to 808
- BS 9210 N006

**APPLICATIONS**

- Telecommunications
- Aeronautics
- Measurement and Test systems
- General electronics

Interface

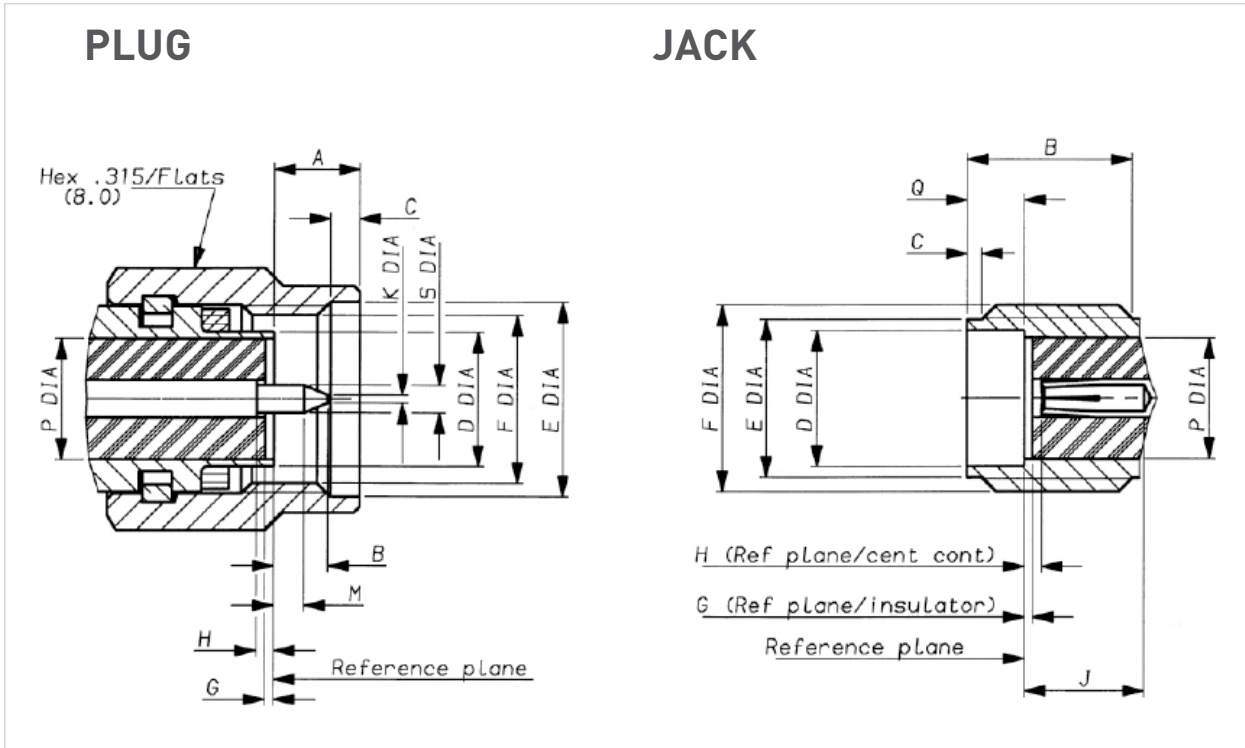

Letter	mm		inch	
	min.	max.	min.	max.
A	-	3.43	-	.135
B	-	2.54	-	.100
C	0.38	1.14	.015	.045
D DIA	-	4.59	-	-
E DIA	6.35	-	.250	-
F DIA	1/4 36 UNS 2B			
G*	0.0	-0.20	0.0	-.008
H*	0.0	-0.25	0.0	-.010
J	-	-	-	-
K DIA	-	0.38	-	.015
M	1.27	-	.050	-
P DIA	4.10 nom.		.161 nom.	
Q DIA	-	-	-	-
S DIA	0.90	0.94	.035	.037

Letter	mm		inch	
	min.	max.	min.	max.
A	-	-	-	-
B	4.31	-	.170	-
C	0.38	1.14	.015	.045
D DIA	4.596	-	.181	-
E DIA	5.28	5.49	.208	.216
F DIA	1/4 36 UNS 2A			
G*	0.0	-0.20	0.0	-.008
H*	0.0	-0.25	0.0	-.010
J	2.92	-	.115	-
K	-	-	-	-
M	-	-	-	-
P DIA	4.10 nom.		.161 nom.	
Q	1.88	1.98	.074	.078
S DIA	-	-	-	-

**NOTE:**  
Means behind ref plane

## Characteristics

Test / Characteristics	MIL-C-39012 paragraph	Values / Remarks
------------------------	-----------------------	------------------

### GENERAL

Impedance	-	50Ω
Frequency range	-	Semi-rigid cables
	-	Standard models
Temperature range	-	DC - 18 GHz
	-	DC - 12.4 GHz
	-	- 65°C + 105°C
	-	- 65°C + 165°C

### ELECTRICAL CHARACTERISTICS

Insulation resistance	3-11	5000 MΩ mini.			
Contact resistance	3-16	Initial		After test	
	• Outer conductor	-	3 mΩ	4 mΩ	
• Inner conductor	-	2 mΩ	3 mΩ		
V.S.W.R. max up to: 18 GHz for semi-rigid cable 12.4 GHz for right angle connector (SR) 12.4 GHz for flexible cable	3-14	.085"	.141"	2.6/50/S	5/50/D
		• Straight Connector	1.07 + .01F	1.05 + .01F	1.15 + .02F
• Right angle connector		1.10 + .01F	1.10 + .01F	1.15 + .03F	1.15 + .02F
Dielectric withstanding voltage in VRMS	3-17	750	1000	750	1000
Working voltage in VRMS (sea level)	-	335	500	250	335
Working voltage in VRMS (70 000 ft)	-	85	125	65	85
RF testing voltage at 5 MHz in VRMS	3-23	500	670	500	670

### MECHANICAL CHARACTERISTICS

Cable retention force	3-24	.085"	.141"	2.6/50/S	5/50/D
		130 N	270 N	90 N	204 N
Life	3-15	100 matings			
Force to engage and disengage	3-5-1	23 Ncm - 2 inch pounds			
Coupling nut torque recommended	-	60 Ncm - 5.2 inch pounds			
Coupling nut retention force	3-25	272 N min			

### ENVIRONMENTAL CHARACTERISTICS

Vibration	3-18	MIL STD 202, method 204, condition D,20g
Shock	3-19	MIL STD 202, method 213, condition 1,100g
Thermal shock	3-20	MIL STD 202, method 107, condition B,
Corrosion (salt spray)	3-13	MIL STD 202, method 101, condition B,
Moisture resistance	3-21	MIL STD 202, method 106
Barometric pressure	3-22	MIL STD 202, method 105, condition C
Hermetic test	-	Down to 10 <sup>-6</sup> mmHg (Torr) leakage rate < 10 <sup>-8</sup> atm/cm <sup>3</sup> /sec
Life (at high temperature)	-	MIL STD 202, method 108

### MATERIALS AND PLATING

	Material	Plating
Bodies	Brass	BBR* or Gold plated
Center contacts	Beryllium copper (female) Brass (male)	Gold plated
Insulators	PTFE teflon	-
Gaskets	Silicone rubber	-

\*BBR: Bright Bronze Radiall

All dimensions are given in mm.

Standard packaging: 100 pieces

Plugs

STRAIGHT PLUGS, FULL CRIMP TYPE FOR FLEXIBLE CABLE

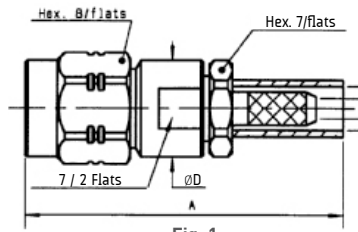

Fig. 1

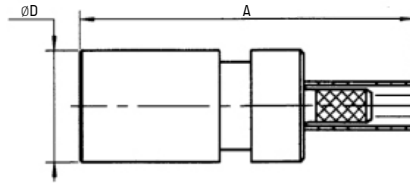

Fig. 2

Cable group	Cable group dia.	Part number (Gold)	Part number (BBR)	Fig.	Dimensions (mm)		Captive center contact	Note
					A	D		
RG178 / RG196	2/50/S	R124 069 123	R124 069 120	1	25	7.7	Yes	Back nut / Solder contact
RG174 / RG316	2.6/50/S	R124 071 123	R124 071 120	2	23.4			-
RD316	2.6/50/D	-	R124 072 220		26.4			-
RG58 / RG141	5/50/S	R124 075 323	R124 075 320	1	26.3			-
RG142 / RG223 / RG400	5/50/D	R124 076 323	R124 076 320		27.15			7
AEP-195FR	LMR® 195	-	R124 075 210		29.15	7	-	
AEP-200FR	LMR® 200	-	R124 076 450	1	33.59	12.7	Crimp type	
AEP-240FR	LMR® 240	-	R124 076 430					
AEP-400FR	LMR® 400	-	R124 080 030					

STRAIGHT PLUGS, SOLDER TYPE FOR SEMI-RIGID CABLE

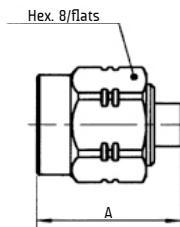

Fig. 1

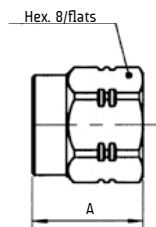

Fig. 2

Cable group	Cable group dia.	Part number (Gold)	Fig.	Dimensions A (mm)	Captive center contact
RG405	.085"	R124 052 013	1	11.1	No
RG402	.141"	R124 054 003	2	8.5	Yes
		R124 055 003	1	11.2	No

## Plugs and Jacks

### RIGHT ANGLE PLUGS

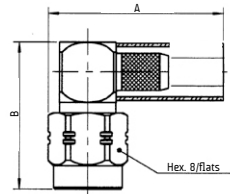

Fig. 1

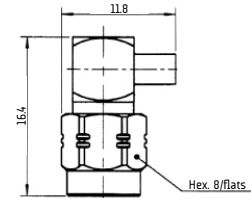

Fig. 2

Cable group	Cable group dia.	Part number (Gold)	Part number (BBR)	Fig.	Dimensions (mm)		Note
					A	B	
RG174 / RG316 / AEP-100FR	2.6/50/S & LMR® 100	R124 172 123	R124 172 120	1	18	16.35	Crimp type for flexible cable
RD316	2.6/50/D	R124 174 123	R124 174 120				
RG58 / RG141	5/50/S	R124 175 123	R124 175 120				
RG142 / RG223 / RG400	5/50/D	R124 176 123	R124 176 120				
AEP-195FR	LMR® 195	-	R124 175 110	2	16.29	19.67	Crimp type
AEP-200FR	LMR® 200	-	R124 175 200				
AEP-240FR	LMR® 240	-	R124 175 310				
RG405	.085"	R124 153 003	R124 153 001				
RG402	.141"	R124 154 001	R124 154 001		-	-	Solder type for semi-rigid cable

### STRAIGHT JACKS

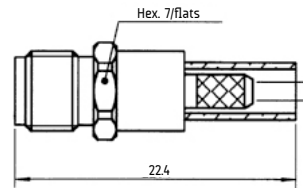

Fig. 1

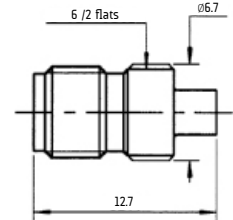

Fig. 2

Cable group	Cable group dia.	Part number (Gold)	Fig.	Captive center contact	Note
RD316	2.6/50/D	R124 233 123	1	Yes	Full crimp type for flexible cable
RG174 / RG316	2.6/50/S	R124 236 123			
RG405	.085"	R124 222 003	2	No	Solder type for semi-rigid cable

Jacks

**BULKHEAD FEEDTHROUGH STRAIGHT JACKS, FULL CRIMP TYPE, FOR FLEXIBLE CABLE**

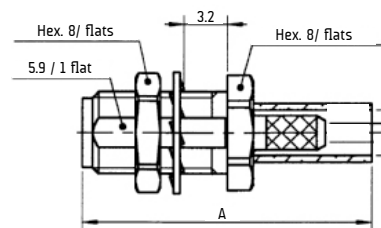
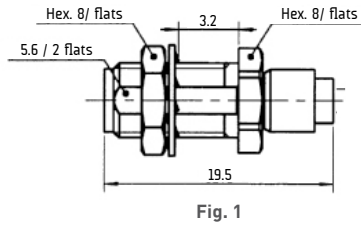
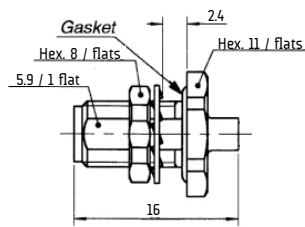

Fig. 2

Cable group	Cable group dia.	Part number (Gold)	Part number (BBR)	Fig.	Dimensions A (mm)	Panel drilling	Captive center contact	Note
RG178 / RG196	2/50/S	R124 310 023	-	1	-	P06		Reverse crimping / Solder contact
RG174 / RG316 / AEP-100FR	2.6/50/S & LMR® 100	R124 312 123	R124 312 120	2	22.4	P05	Yes	-
RG 58 / RG141	5/50S	-	R124 314 120		25.4			Full crimp type
RG142 / RG223 / RG400	5/50/D	-	R124 315 120					

**BULKHEAD FEEDTHROUGH STRAIGHT JACKS, SOLDER TYPE, FOR SEMI-RIGID CABLE - PANEL SEAL**



Cable group	Cable group dia.	Part number (Gold)	Panel drilling	Captive center contact
RG405	.085"	R124 326 003	P05	No
RG402	.141"	R124 325 003		

**FLANGE JACKS, SOLDER TYPE FOR SEMI-RIGID CABLE**

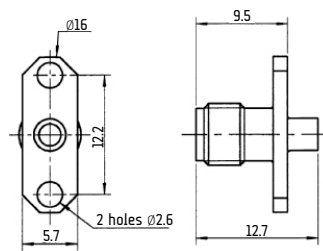

Fig. 1

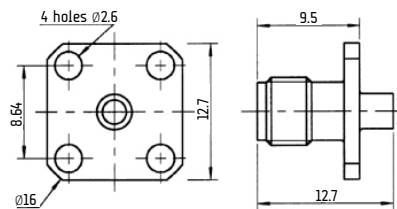

Fig. 2

Cable group	Cable group dia.	Part number (Gold)	Fig.	Panel drilling	Captive center contact
RG405	.085"	R124 252 003	1	P04	No
		R124 256 003	2	P02	
RG402	.141"	R124 255 003			

Receptacles

SQUARE FLANGE FEMALE RECEPTACLES

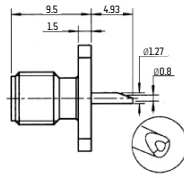
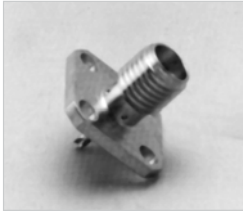

Fig. 1

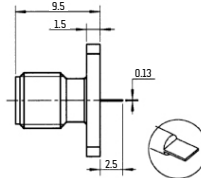

Fig. 2

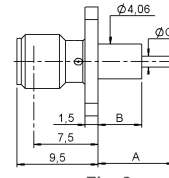

Fig. 3

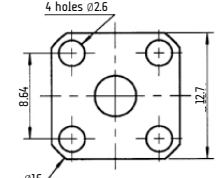

Fig. 1 to 3

Part number	Fig.	Dimensions (mm)			Panel drilling	Finish	Captive center contact
		A	B	C			
R124 403 123	1	-	-	-	P01	Gold	Yes (4 indents)
R124 413 025	3	8.9	5.1	1.28			
R124 415 273		17.9	15	1.27			
R124 510 000	2	-	-	-	BBR		

NARROW FLANGE FEMALE RECEPTACLES

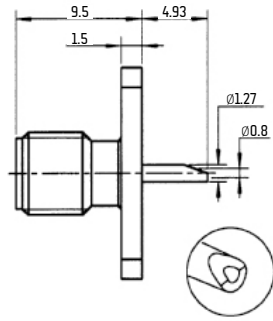

Fig. 1

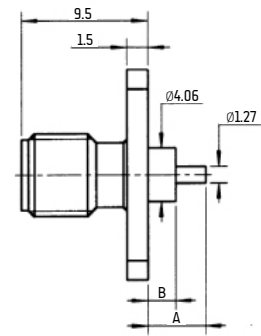
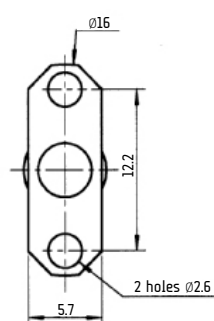
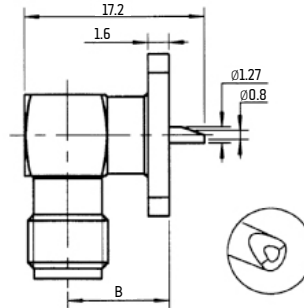
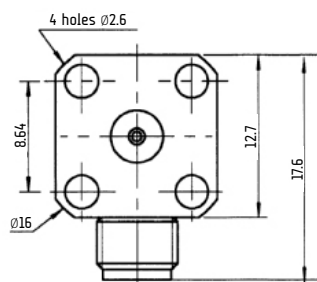

Fig. 2

Part number	Fig.	Dimensions (mm)		Panel drilling	Finish	Captive center contact
		A	B			
R124 454 123	1	-	-	P04	Gold	Yes (4 indents)
R124 464 000	2	15.9	12.7		BBR	

RIGHT ANGLE SQUARE FLANGE FEMALE RECEPTACLES



Part number	Panel drilling	Finish
R124 654 003	P02	Gold

Switches

STRAIGHT FEMALE PCB RECEPTACLES AND SWITCHES

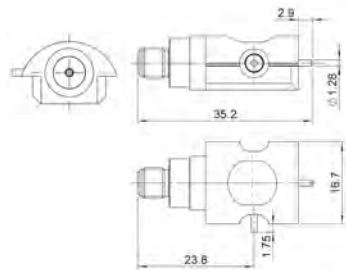

Fig. 1

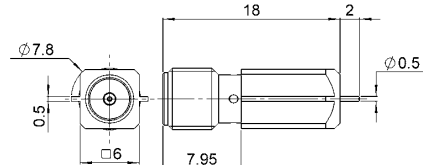

Fig. 2

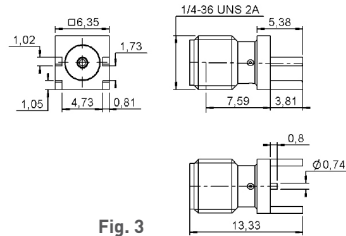

Fig. 3

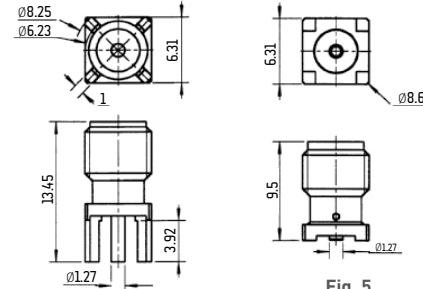

Fig. 4

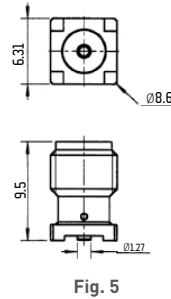

Fig. 5

Part number	Fig.	Panel drilling	Assembly instructions	Finish	Note
R124 422 001	1	-	M03	Gold	Switch edge card SMT - Right type - Packaging in Reel 110 pieces
R124 423 033	2	-	M02		SMT edge card type - Packaging: unit
R124 423 223	3	-	-	-	-
R124 426 120	4	P03	-	BBR	-
R124 426 123			-	-	-
R124 427 000	5	-	M01	Gold	Surface mount / Bulkhead 100 pieces
R124 427 800		-			Surface mount / Tape & Reel 100 pieces

RIGHT ANGLE FEMALE PCB RECEPTACLES

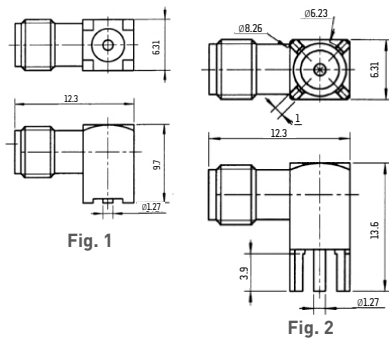

Fig. 1

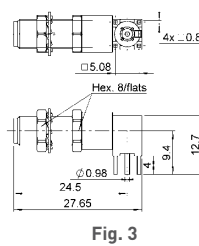

Fig. 3

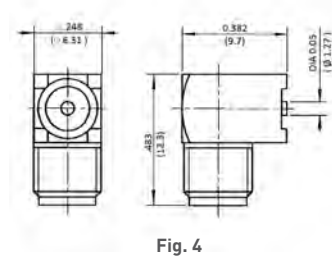

Fig. 4

Part number	Fig.	Panel drilling	Assembly instructions	Finish	Note
R124 667 143	3	P07	-	Gold	Packaging: tray 60 pieces
R124 680 120	2	P03	-	BBR	-
R124 680 123				-	-
R124 681 000	1	-	M01	Gold	Surface mount / Bulkhead 100 pieces
R124 681 800	4	-	M04		Packaging: Tape & Reel 100 pieces



## Receptacles

### MALE CAP

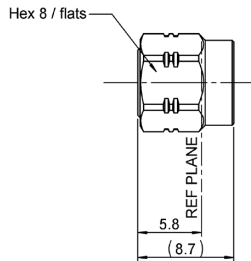

Part number	Finish	Note
R124 802 108	Tin	No chain

## ADAPTERS

For in series adapters, please see standard SMA.

## Panel Drilling

### P01

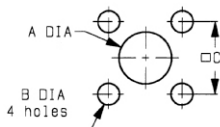

	MM		INCH	
	maxi	mini	maxi	mini
A	4.2	4.1	0.165	0.161
B	2.7	2.6	0.106	0.102
C	8.69	8.59	0.342	0.338

### P02

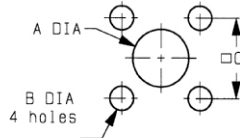

	MM		INCH	
	maxi	mini	maxi	mini
A	6.6	6.5	0.26	0.256
B	2.7	2.6	0.106	0.102
C	8.69	8.59	0.342	0.338

### P03

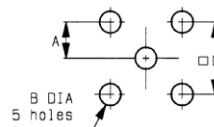

	MM		INCH	
	maxi	mini	maxi	mini
A	2.59	2.49	0.102	0.098
B	1.7	1.6	0.067	0.063
C	5.13	5.03	0.202	0.198

### P04

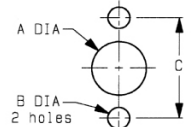

	MM		INCH	
	maxi	mini	maxi	mini
A	4.2	4.1	0.165	0.161
B	2.7	2.6	0.106	0.102
C	12.25	12.15	0.482	0.478

### P05

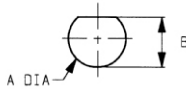

	MM		INCH	
	maxi	mini	maxi	mini
A	6.5	6.4	0.256	0.252
B	6.15	6	0.242	0.238

### P06

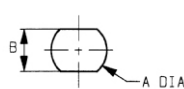

	MM		INCH	
	maxi	mini	maxi	mini
A	6.5	6.4	0.256	0.252
B	5.8	5.7	0.228	0.224

### P07

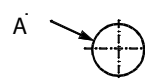

	mm	
	Maxi	mini
A	6.40	6.35

Assembly Instructions

M01

Part number	
R124 427 000 R124 427 800	R124 681 000

SOLDERING PATTERN

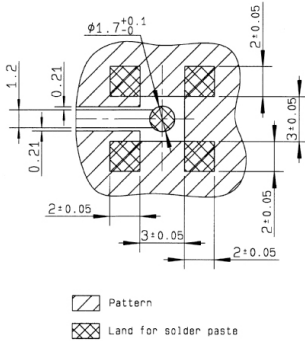

COPLANAR LINE

- Pattern and signal are on the same side
- Thickness of PCB: 1.6 mm
- The PCB material is made of epoxy resin of glass fabrics bacs ( $E_r = 4.8$ )
- The solder resist should be printed except for the land pattern on the PCB

ASPIRATION PORT

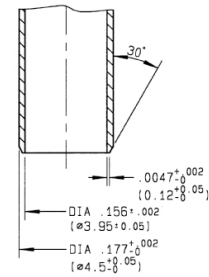

VIDEO SHADOWS

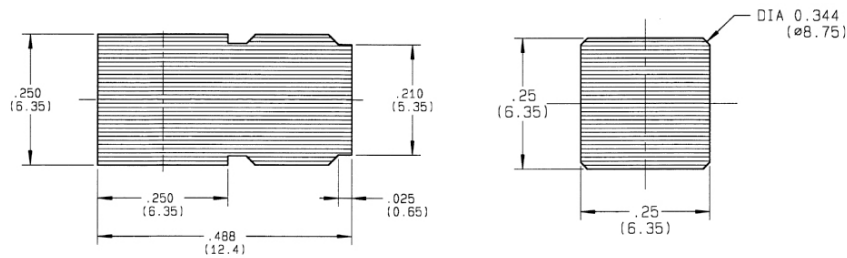

M02

SOLDERING PATTERN

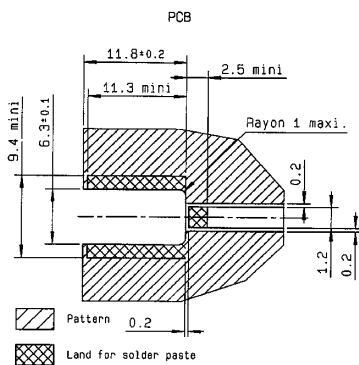

Part number
R124 423 033

COPLANAR LINE

- Pattern and signal are on the same side
- Thickness of PCB: .063 (1.6 mm)
- The PCB material is made of epoxy resin of glass fabrics bacs. ( $E_r = 4.8$ )
- The solder resist should be printed except for the land pattern on the PCB

ASPIRATION PORT

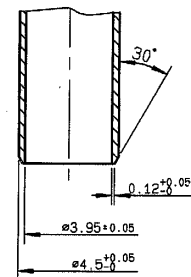

VIDEO SHADOW

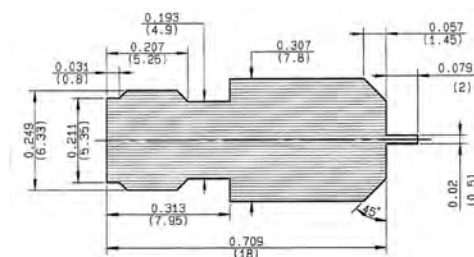

## Assembly Instructions

### M03 PCB FOR SMA SWITCH

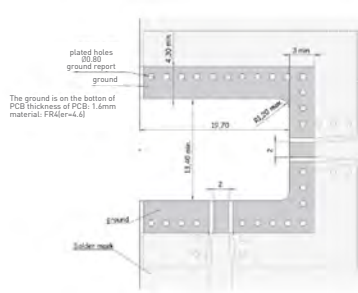

Part number
R124 422 001

### VIDEO SHADOW

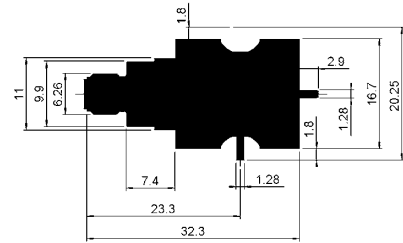

### M04 SOLDERING PATTERN

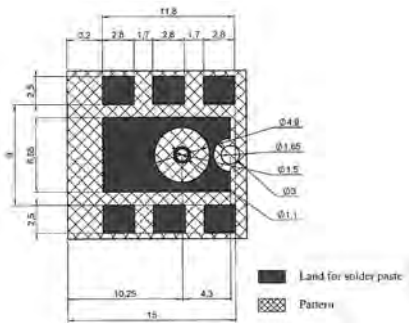

Part number
R124 681 800

### VIDEO SHADOW

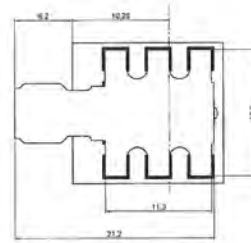

### COPLANAR LINE

- Pattern and signal are on the same side
- Thickness of PCB: .063 (1.6 mm)
- The PCB material is made of epoxy resin of glass fabrics bacs. (Er = 4.8)
- The solder resist should be printed except for the land pattern on the PCB



## QUICK-LOCK: QMA/WQMA/QN/QRE™

R123/R123W/R164/R324

**Contents****QMA and WQMA**

Introduction .....	8-4 to 8-5
Characteristics .....	8-6 to 8-7
QMA plugs and jacks .....	8-8 to 8-9
QMA receptacles .....	8-9 to 8-10
QMA accessories and adapters .....	8-11 to 8-12
QMA panel drilling and assembly instructions .....	8-12 to 8-13
WQMA plugs, jacks and receptacles .....	8-14

**QN**

Introduction .....	8-4 to 8-5
Characteristics .....	8-15 to 8-16
Plugs and jacks .....	8-16 to 8-18
Receptacles .....	8-18 to 8-19
Adapters .....	8-19
Protective cap .....	8-20
Panel drilling .....	8-20

**QRE™**

Introduction .....	8-21
Characteristics .....	8-21
Plugs, jacks and receptacles .....	8-22
Adapters .....	8-23
Panel drilling .....	8-23

## Introduction

**"Quick-Lock Formula™" - A cost saving solution**

Radiall's patented QMA and QN connectors are now the standard for the RF telecommunication industry. The "QLF" registered trademark, Quick-Lock Formula™ standard, applies to the QMA and QN series and guarantees the full intermateability between suppliers using this trademark. Using QLF™ certified connectors also guarantees the highest RF transmission performance.

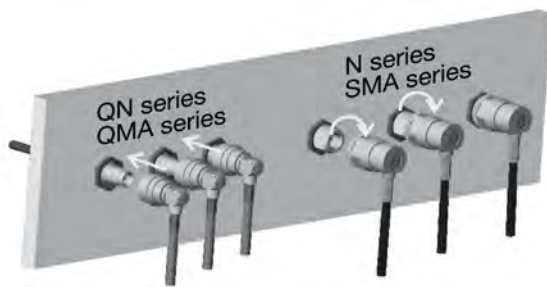

QMA (Quick-Lock SMA) and QN connectors (Quick-Lock N) enable fast, secured, and easy matings with minimum space requirements. The QMA and QN series are the perfect alternative to SMA and N connectors in new generation telecommunication systems as well as in many other RF applications.

**Saves installation time**

QMA and QN connectors are ten times faster to connect compared to N or SMA connectors, reducing the cost of ownership. With their snap-on interface, it takes only two seconds to connect QN and SMA connectors in field conditions.

**Secure connection**

The snap-on connection is insured by a chamfer. In addition, a positive locking system ensures an excellent and secure connection. The disengagement force is lower than the panel tear-off force, preventing any panel damage. QN and QMA connectors have been successfully tested against vibration.

**Offers flexibility**

The cabled plug can freely rotate around the jack, which allows for more flexibility during the mounting process and eases the installation within the equipment.



In addition, it prevents from any added stress on the cable and return loss reduction due to cable bending. As no torque wrench is required, the risk in damaging or scratching the panel is eliminated.

## Introduction

### Space saving

QN and QMA connectors have a lower space requirement since space for the use of a torque wrench is not necessary. Therefore the distance between connectors is optimized on the panel.

### QMA series

The QMA series with Quick-Lock Formula™, is the innovative patented snap-on generation of brass SMA connectors. With the same interface dimensions, QMA connectors have the identical high electrical performance as the SMA series with an easier and faster mounting design. The QMA series is a cost effective solution for the new generation of base stations. The QMA series is designed for DC to 18 GHz. This series features 100 matings and total reliability as the standard commercial SMA connectors. They are fast and easy to connect and disconnect. The new QMA series offers a large range of connectors: straight and right angle plugs, bulkhead jacks, flange receptacles, PCB receptacles, adapters and more. Models are either full crimp, crimp or solder type for flexible, semi-rigid or conformable cables.

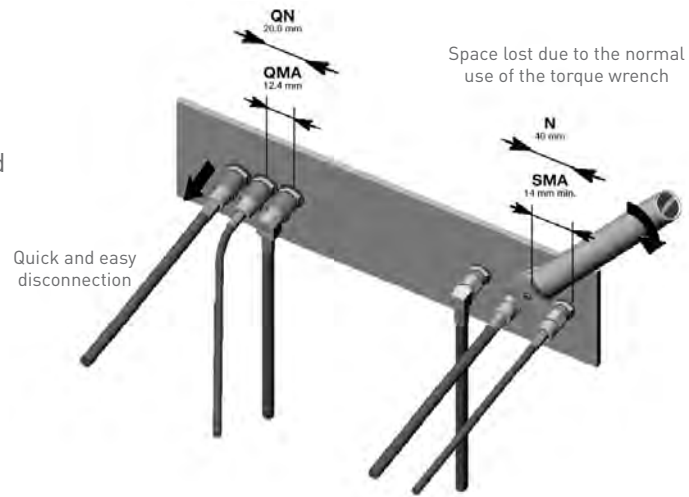

### WATERPROOF QMA series

Radiall expands its QMA product line with new high density RF coaxial **Waterproof QMA (WQMA)** connector solutions with fast and easy snap-on Quick Lock technology. WQMA connectors offer outstanding electrical performance and have environmental characteristics that provide for long lasting durability needed for the most demanding harsh outdoor applications, thus eliminating the need for costly and bulky watertight enclosures or cable entries.

**Waterproof QMA CONNECTORS** are fully intermateable and backward compatible with any QLF™ certified standard QMA connectors and they provide for excellent ingress protection.

- IP 68 rating when mated
- 100 matings minimum for durability
- Wide temperature range -40°C / +105°C
- Power rating 200W @ 1 GHz, 75°C

### QN series

Offering the same operating frequency range between DC and 11 GHz as the N series, the new QN series performance has been **optimized from DC to 6 GHz for 50Ω applications**. The new QN interface typically features a VSWR of 1.05 from DC to 3 GHz and 1.12 from 3 to 6 GHz. The corresponding return loss is **32 dB from DC to 3 GHz and 25 dB from 3 to 6 GHz**. The high screening effectiveness enables a level of RF leakage as low as -90 dB from DC to 3 GHz and -80 dB from 3 to 6 GHz.

Designed for indoor and outdoor applications such as BTS, antenna systems or test and measurement devices, QN connectors offer an outstanding intermodulation level (-155 dBC / -112 dBm) and IP rating (water and dust protection). The power rating is **300 W at 2.5 GHz** and features **100 matings**.

## QMA Characteristics

Test / Characteristics	Values / Remarks
<b>ELECTRICAL CHARACTERISTICS</b>	
Impedance	50Ω
Frequency range	DC - 6 GHz (optimized) DC - 18 GHz (working range)
Typical V.S.W.R. • DC - 3 GHz • 3 GHz - 6 GHz	1.06 1.12
Max insertion loss	0.25 dB
Insulation resistance	5000 MΩ
Voltage rating	≤ 500 V RMS 50 Hz, sea level
Dielectric withstanding voltage	1500 V RMS 50 Hz, sea level
Contact resistance • Center contact • Outer contact	< 3 mΩ < 2.5 mΩ
Admissible power @ 2.5 GHz (continuous power)	125 W @ T = 40°C (150 W @ T = 23°C)
Passive Intermodulation	-120 dBc @ 1.8 GHz [2x20W] (static)
RF leakage • DC - 3 GHz • 3 - 6 GHz	-80 dB min -70 dB min

**MECHANICAL CHARACTERISTICS**

Mechanical endurance	100 matings
Engagement and disengagement force • Engagement • Disengagement	25 N 20 N
Retention force for interface	> 60 N
Cable retention force 2.6 / 50 S 2.6 / 50 D 5 / 50 S 5 / 50 D 5.7 / 50 D	90 N 110 N 180 N 200 N 220 N
Distance between connectors: c. to c.	12.4 mm min.
Vibration	40 m.s <sup>-2</sup> at 500 Hz

**ENVIRONMENTAL CHARACTERISTICS**

Temperature range	-40 °C, +105 °C
-------------------	-----------------

**MATERIALS**

Connector bodies	Brass
Male center contact	Brass
Female center contact	Beryllium copper
Outer contact	Bronze
Other metallic parts	Brass
Insulators	PTFE

**PLATING**

Bodies	BBR
Solder bodies	BBR
SMT Bodies	NPGR
Outer contacts	BBR
Center contacts	NPGR

All dimensions are given in mm.



QMA Characteristics

POWER RANGE

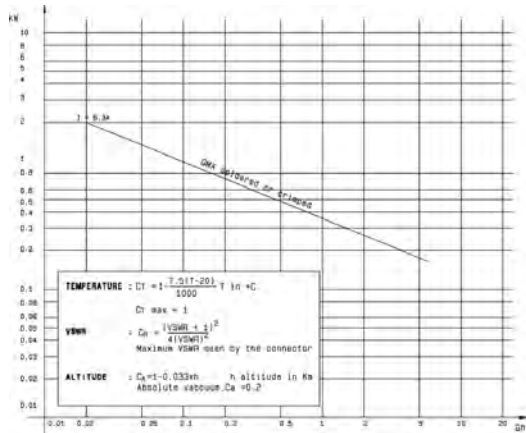

WQMA Characteristics

Test / Characteristics	Values / Remarks
<b>ELECTRICAL AND MECHANICAL CHARACTERISTICS</b>	
Impedance	50Ω
Frequency	DC - 6 GHz
V.S.W.R.	1.02 + 0.0200*F (GHz) Max
Center contact captivation	Yes
Working temperature range	- 40°C / + 105°C
Mating cycles	100

MATERIALS AND PLATING

	Materials	Platings
Connector body	Brass	BBR / NPGR / Gold over Copper
Male center contact	Brass	NPGR
Female center contact	Beryllium copper	NPGR / Gold over Copper
Outer contact and other metallic parts	Brass	BBR
Gasket	Silicone	
Insulator	PTFE	

ENVIRONMENTAL CHARACTERISTICS

Waterproofing	IP68	In mated condition
---------------	------	--------------------

QMA Plugs

**STRAIGHT PLUGS**

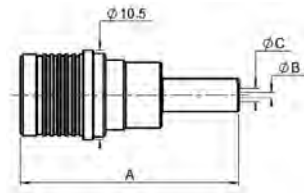

Fig. 1

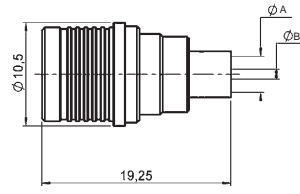

Fig. 2

Cable group	Cable group dia.	Part number	Fig.	Dimensions (mm)			Captive center contact	Finish	Packaging	Note
				A	B	C				
RG174 / RG316 / AEP-100FR	2.6/50/S & LMR <sup>®</sup> 100	R123 071 000	1	25.5	0.6	1.61	Yes	BBR	100 pieces	Crimp type
RD316	2.6/50/D	R123 072 000		25.5	0.6	1.61				
RG58 / RG141	5/50/S	R123 075 000		28.5	1.05	3.11				
RG142 / RG223 / RG400	5/50/D	R123 076 000	2	28.5	1.05	3.11				
RG405	.085"	R123 054 000		2.275	0.6	-				
RG402	.141"	R123 055 000		3.675	1	-				
AEP-195FR	LMR <sup>®</sup> 195	R123 075 200	1	28.5	1.05	3.11				
AEP-200FR	LMR <sup>®</sup> 200	R123 096 110		28.5	1.18	3.25				
AEP-240FR	LMR <sup>®</sup> 240	R123 076 310		30.5	1.5	4.05				

Plugs

**RIGHT ANGLE PLUGS**

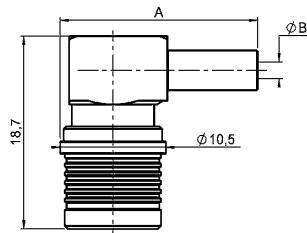

Fig. 1

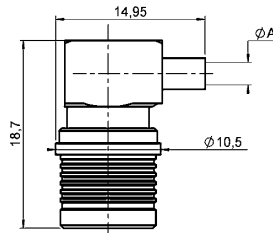

Fig. 2

A right angle plug for 5.7 mm dia. cable is also available, please consulte us.

Cable group	Cable group dia.	Part number	Fig.	Dimensions (mm)		Captive center contact	Finish	Packaging	Note
				A	B				
RG174 / RG316	2.6/50/S	R123 172 000	1	19.7	0.6	Yes	BBR	100 pieces	Crimp type
RD316	2.6/50/D	R123 174 000		19.7	0.6				
RG58 / RG141	5/50/S	R123 175 000		22.7	3.1				
RG142 / RG223 / RG400	5/50/D	R123 176 000		22.7	3.1				
AEP-240FR	LMR <sup>®</sup> 240	R123 177 100	2	22.65	4.05				
RG405	.085"	R123 153 000		2.25	-				
		R123 153 003		2.25					
		R123 154 000		3.7					
RG402	.141"	R123 154 003	3.7					Gold	
					BBR				
					Gold				

Jacks and Receptacles

STRAIGHT BULKHEAD JACKS

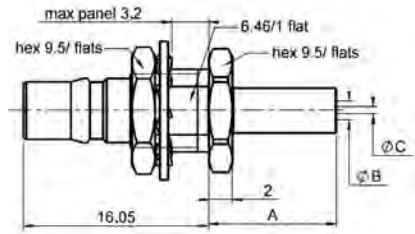

Fig. 1

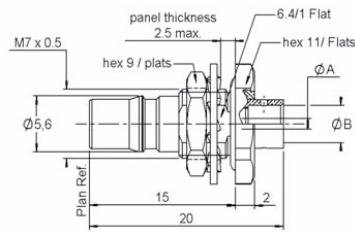

Fig. 2

Cable group	Cable group dia.	Part number	Fig.	Dimensions (mm)			Captive center contact	Panel drilling	Finish	Packaging	Note
				A	B	C					
RG174 / RG316	2.6/50/S	R123 312 000	1	11	0.6	1.61	Yes	P02	BBR	100 pieces	Full crimp type
RD316	2.6/50/D	R123 313 000		11	0.6	1.61					
RG58 / RG141	5/50/S	R123 314 000		14	1.05	3.11					
RG142 / RG223 / RG400	5/50/D	R123 315 000		14	1.05	3.11					
AEP-240FR	LMR® 240	R123 314 010	2	16	4.05	1.5	-	P02	Gold		Crimp type
RG405	.085"	R123 326 003		0.6	2.25	-					Solder type
RG402	.141"	R123 305 023		1	3.7	-					panel seal

STRAIGHT FLANGE FEMALE RECEPTACLES

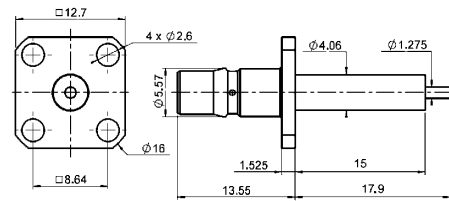

Fig. 1

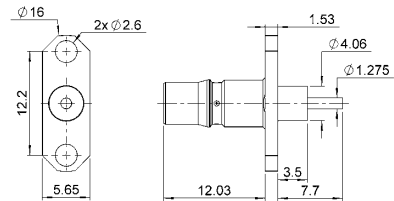

Fig. 2

Part number	Fig.	Captive center contact	Dimensions (mm)		Panel drilling	Finish	Note
			A	B			
R123 415 000	1	Yes	15	17.9	P01	BBR	Straight flange
R123 425 100			10	13			Straight flange Panel seal
R123 464 110	2	-	-	-	P04		Straight flange

RECEPTACLES

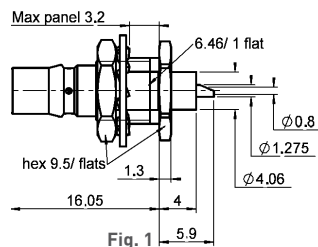

Fig. 1

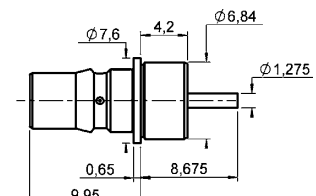
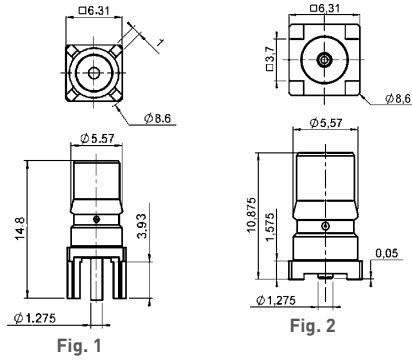

Fig. 2

Part number	Fig.	Captive center contact	Panel drilling	Finish	Note
R123 553 000	1	Yes	P02	BBR	Bulkhead receptacle
R123 590 027	2		P05	NPGR	Press mount

Receptacles

STRAIGHT PCB RECEPTACLES



Part number	Fig.	Captive center contact	Finish	Assembly instructions	Panel drilling	Packaging	Note
R123 426 003	1			-	P03	100/Bulk	-
R123 427 803	2	Yes	NPGR	M01	-	100/Reel	SMT

PCB RECEPTACLES

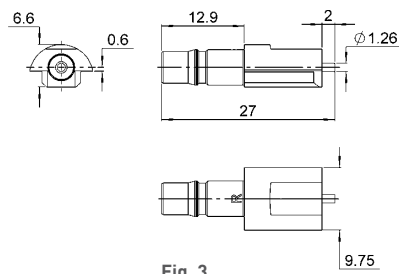
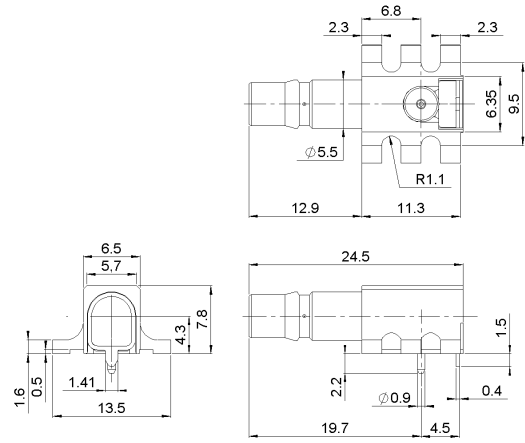
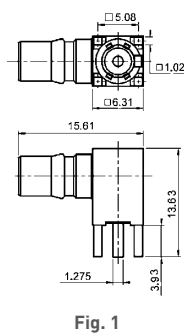

Part number	Fig.	Captive center contact	Finish	Assembly instructions	Panel drilling	Packaging	Note
R123 680 003	1			-	P03	100/Bulk	-
R123 682 827	2	Yes	NPGR	M01	-	100/Reel	Right angle SMT
R123 682 880				-	-	250/Reel	-
R123 444 827	3			-	-	300/Reel	Female edge card

Receptacles

RACK AND PANEL

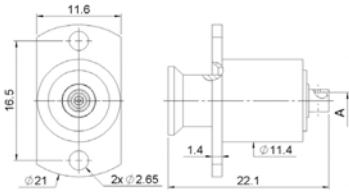

Cable group	Cable group dia.	Part number	Dimensions (mm)	Radial Misalignment	Axial Working Range	Finish	Packaging
			A				
KS1 / RG405	.085 cable	R123 142 000	2.25	Min 1	2.5/4.6	BBR / NPGR	100
KS2 / RG402	.141 cable	R123 141 000	3.65				

Accessories and Adapters

MALE CAPS WITH CORD

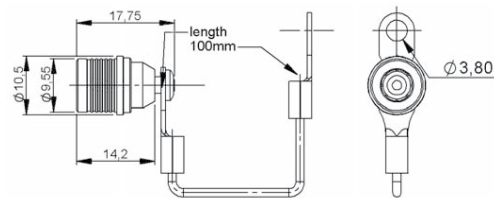

Part number	Finish	Packaging
R123 805 000	BBR	100

IN SERIES ADAPTERS

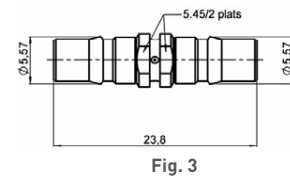
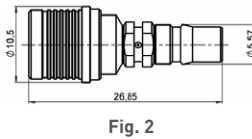
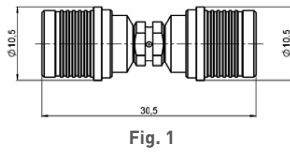

Part number	Fig.	Captive center contact	Finish	Note	Packaging
R123 703 000	1	Yes	BBR	QMA male - QMA male	100 pieces
R123 704 000	2			QMA female - QMA male	
R123 705 000	3			QMA female - QMA female	

BETWEEN SERIES ADAPTERS QMA/SMA

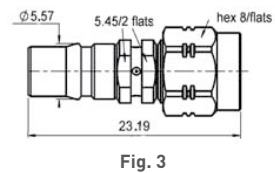
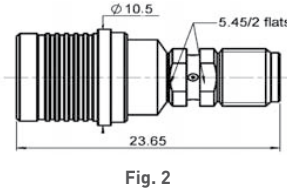
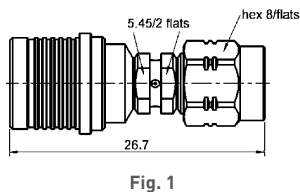

Part number	Fig.	Captive center contact	Finish	Note	Packaging
R191 910 000	1	Yes	BBR	QMA male - SMA male	Unit
R191 911 000	2			QMA male - SMA female	
R191 912 000	3			QMA female - SMA male	
R191 913 000	4			QMA female - SMA female	

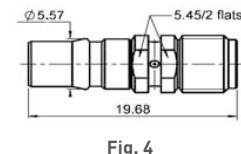

Adapters

BETWEEN SERIES ADAPTERS QMA / N

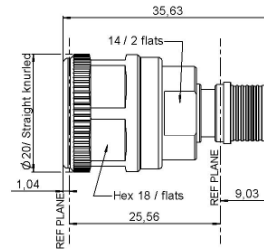
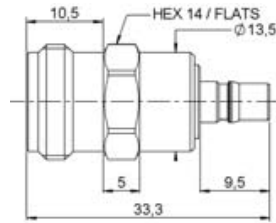
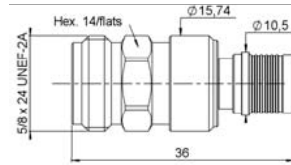
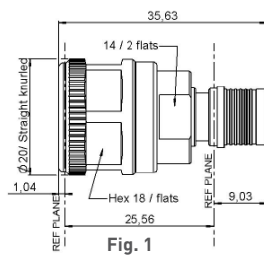

Part number	Fig.	Finish	Note	Packaging
R191 762 000	1	BBR	QMA female - N male	1 Unit
R191 763 000	2		QMA male - N female	
R191 764 000	3		QMA female - N female	
R191 765 000	4		QMA male - N male	

Panel Drilling

P01

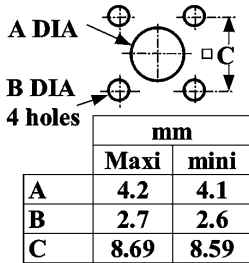

P02

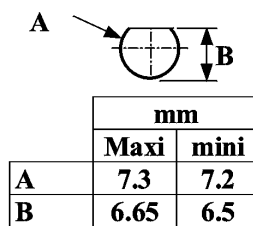

P03

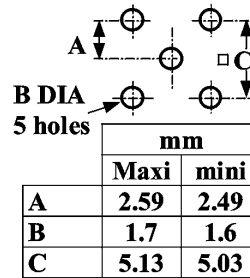

P04

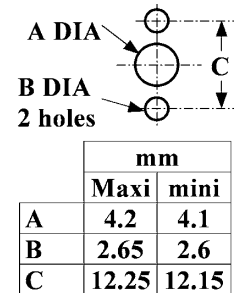

P05

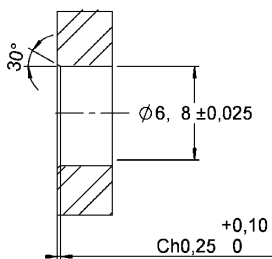

QMA Receptacle Packaging

**TAPE AND REEL**

ACCORDING TO IEC  
286-3 STANDARD

**MATERIALS**

Reel: polyester

Carrier tape: antistatic PETG (polyester)

Cover tape: polyester

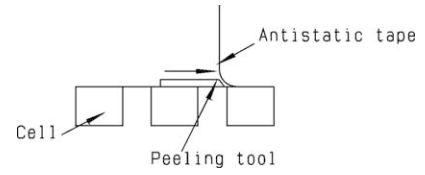
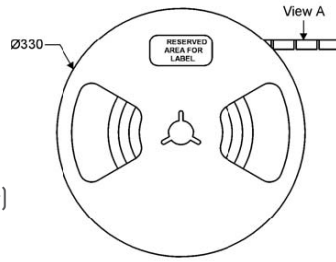

View A

Part number
R123 427 803

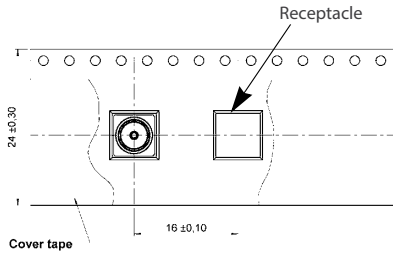

Part number
R123 682 827

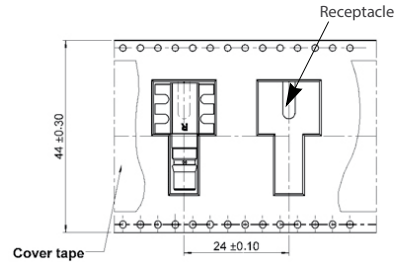

Assembly Instructions

**M01**

Receptacle soldering pattern

Part number
R123 427 803

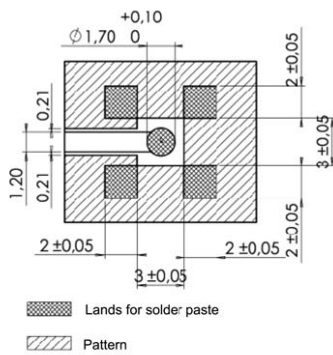

Part number
R123 682 827

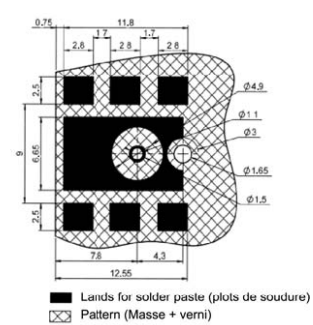

COPLANAR LINE: Pattern and signal are on the same side. Thickness of PCB = 1.6 mm. The material of PCB is the glass epoxy resin (Er = 4.8). The solder paste should be printed except for the land pattern on the PCB.

Video shadow

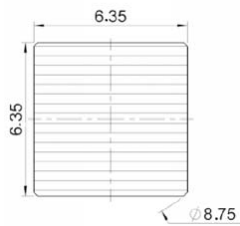

Vacuum nozzle dimensions:

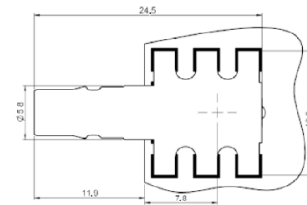
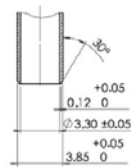

Plugs, Jacks and Receptacles

STRAIGHT PLUGS

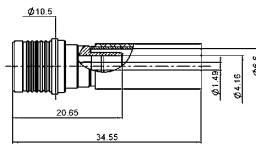

Fig. 1

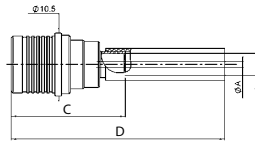

Fig. 2

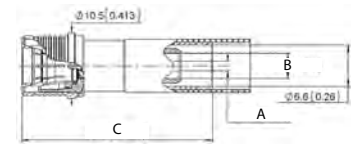

Fig. 3

Cable group	Cable group dia.	Part number	Fig.	Dimensions				Finish	Ingress protection	Note	Packaging
				A	B	C	D				
ECO 230	6/50/D	R123W 096 100	1	-	-	-	-	BBR	IP68	Crimp type	100 pieces
Hand formable / RG405	.085"	R123W 054 000	2	0.6	2.275	-	-			Solder type	
Hand formable / RG402	.141"	R123W 055 000		1.0	3.70	-	-			Crimp type	
AEP-240FR	LMR® 240	R123W 076 310	3	1.5	4.05	30.5	-				

RIGHT ANGLE PLUGS

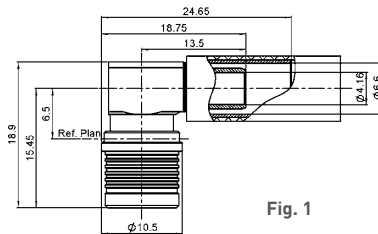

Fig. 1

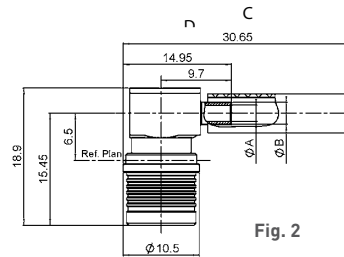
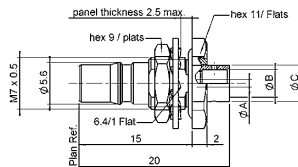

Fig. 2

For assembling, tool **R282 761 000** is recommended

Cable group	Cable group dia.	Part number	Fig.	Dimensions				Finish	Ingress protection	Note	Packaging
				A	B	C	D				
ECO 230	6/50/D	R123W 176 000	1	26.3	3.11	-	-	BBR	IP68	Crimp type	100 pieces
Hand formable / RG405	.085"	R123W 153 000	2	2.275	3.05	-	-			Solder type	
Hand formable / RG402	.141"	R123W 154 000		3.70	4.40	-	-			Crimp type	
AEP-240FR	LMR® 240	R123W 177 110		4.05	6.6	24.65	18.75				

STRAIGHT BULKHEAD JACKS SOLDER TYPE (panel seal)



Cable group	Cable group dia.	Part number	Dimensions			Finish	Ingress protection	Packaging
			A	B	C			
Hand formable / RG405	.085"	R123 326 003	0.60	2.275	3.05	Gold	IP67	100 pieces
Hand formable / RG402	.141"	R123 305 023	1.00	3.70	4.80			

RECEPTACLES (panel seal)

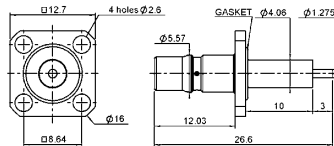

Part number	Finish	Ingress protection	Note	Packaging
R123 425 100	BBR	IP67	Square flange	100 pieces

MALE WATERPROOF PROTECTIVE CAP

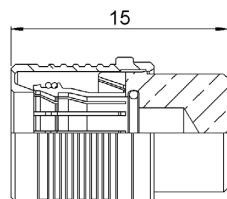
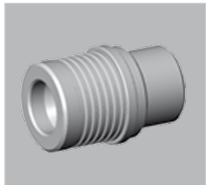

Fig. 1

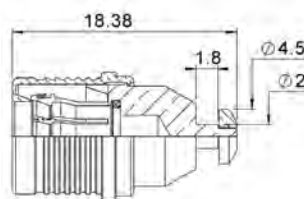

Fig. 2

Part number	Fig.	Finish	Sealing	Packaging
R123W 805 700	1	BBR	IP68	100
R123W 805 710	2			



## Characteristics

Test / Characteristics	Values / Remarks
------------------------	------------------

## ELECTRICAL CHARACTERISTICS

Impedance	50Ω						
Frequency range	DC - 6 GHz (optimized) DC - 11 GHz (working range)						
Return loss typical <ul style="list-style-type: none"> <li>DC - 3 GHz</li> <li>3 GHz - 6 GHz</li> </ul>	<ul style="list-style-type: none"> <li>≥ 32 dB / 1.05</li> <li>≥ 25 dB / 1.12</li> </ul>						
Intermodulation	Better - 155 dBc (2 x 43 dBm)						
RF Leakage	100 MHz to 3 GHz better than - 90 dB 3 to 6 GHz better than - 80 dB						
Dielectric withstanding voltage in VRMS (interface) <ul style="list-style-type: none"> <li>At sea level, 50 Hz</li> </ul>	2500						
Working voltage in VRMS (interface) <ul style="list-style-type: none"> <li>At sea level, 50 Hz</li> </ul>	≤ 1000						
Insulation resistance	≤ 5.10 <sup>3</sup> MΩ						
Contact resistance <ul style="list-style-type: none"> <li>Initial</li> <li>After test</li> </ul>	<table border="0"> <tr> <td style="text-align: center;">Center contact</td> <td style="text-align: center;">Outer contact</td> </tr> <tr> <td style="text-align: center;">≤ 1 mΩ</td> <td style="text-align: center;">≤ 0.25 mΩ</td> </tr> <tr> <td style="text-align: center;">≤ 1.5 mΩ</td> <td style="text-align: center;">≤ 1 mΩ</td> </tr> </table>	Center contact	Outer contact	≤ 1 mΩ	≤ 0.25 mΩ	≤ 1.5 mΩ	≤ 1 mΩ
Center contact	Outer contact						
≤ 1 mΩ	≤ 0.25 mΩ						
≤ 1.5 mΩ	≤ 1 mΩ						

## MECHANICAL CHARACTERISTICS

Durability matings	≥ 100
Force to engage and disengage <ul style="list-style-type: none"> <li>Typical</li> </ul>	40 N
Retention force for interface	≥ 450 N (101.25 Lbs)
Bending moment admissible interface	≤ 10 Nm
Contact captivation <ul style="list-style-type: none"> <li>Cable connectors</li> <li>Receptacles</li> </ul>	<ul style="list-style-type: none"> <li>≥ 28 N</li> <li>≥ 18 N</li> </ul>

## ENVIRONMENTAL CHARACTERISTICS

Temperature range	- 55°C + 125°C
Climatic category	40 / 125 / 21 (IEC 60169 1 16.2)
Shock	MIL STD 202F, method 213, condition I
Rapid change of temperature	IEC 60169-1 16.4 (-40°C + 125°C)
Corrosion salt spray	Test acc. to MIL STD 202F, method 101D, condition B
Vibration	IEC 1169-1 paragraph 9.3.3 (10-500 Hz; 5g)
Moisture resistance	MIL STD 202 F, method 106F
Water resistance	IP 68

## MATERIALS AND PLATING

	Material	Plating
Body	Brass	BBR over Silver
Center contact	Brass / Beryllium copper	Silver passivated over copper
Outer contact	Beryllium copper	BBR over Silver
Insulator	PTFE	
Others parts	Brass	BBR

All dimensions are given in mm.

Characteristics

POWER RANGE

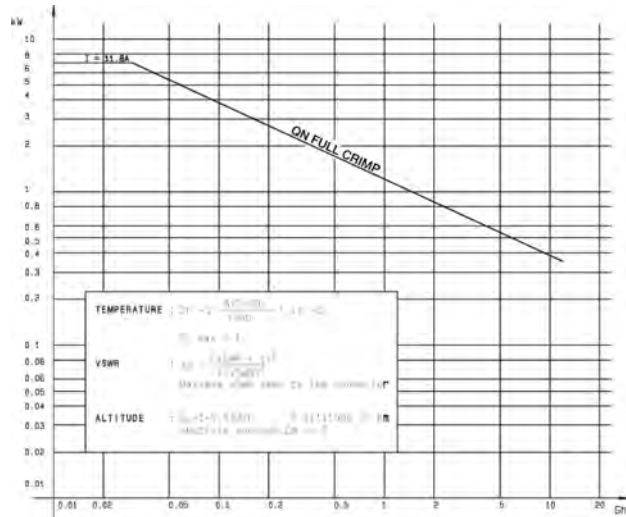

Plugs

STRAIGHT PLUGS, FULL CRIMP TYPE, FOR FLEXIBLE CABLES

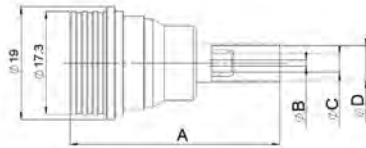

Fig. 1

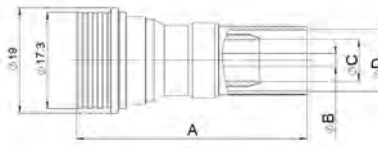
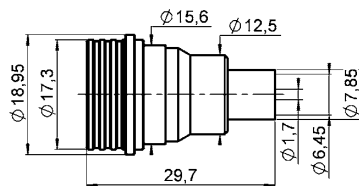

Fig. 2

Cable group	Cable group dia.	Part number	Fig.	Dimensions (mm)				Captive center contact	Packaging
				A	B	C	D		
RG58 / RG141	5/50/S	R164 075 000	1	35.2	1.05	3.1	5.4	No	50 pieces
RG142 / RG223 / RG400	5/50/D	R164 076 000					5.8		
RG213	10/50/S	R164 080 000	2	41.5	2.45	7.5	11.05	Yes	Unit
AEP-240FR	LMR® 240	R164 075 010	1	35.2	1.5	4.05	6.6		50
AEP-400FR	LMR® 400	R164 080 020						2	41.5
AEP-600FR	LMR® 600	R164 080 030	2	44.5	4.7	11.96	15.875	No	Unit

STRAIGHT PLUGS, SOLDER TYPE, FOR SEMI-RIGID CABLES



Cable group	Cable group dia.	Part number	Captive center contact	Packaging
RG401	.250"	R164 054 002	No	50 pieces

Plugs and Jacks

RIGHT ANGLE PLUGS

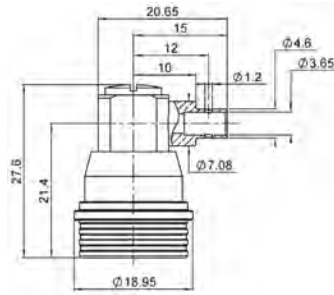
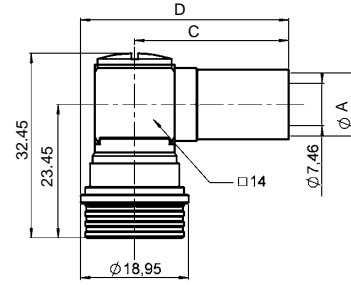
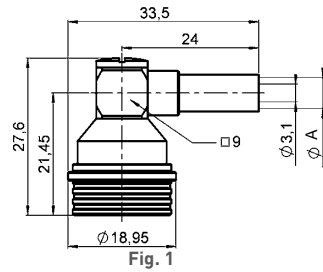

Fig. 3

Cable group	Cable group dia.	Part number	Fig.	Dimensions (mm)			Captive center contact	Packaging	Note
				A	C	D			
RG402	.141"	R164 152 100	3						Solder type
RG58 / RG141	5/50/S	R164 175 000	1	5.41	-	-	Yes	50 pieces	Crimp type
RG142 / RG223 / RG400	5/50/D	R164 176 000		5.8	-	-			
RG213	10/50/S	R164 184 000	2	11.05	27	36.5			
AEP-240FR	LMR® 240	R164 185 007							

STRAIGHT JACKS

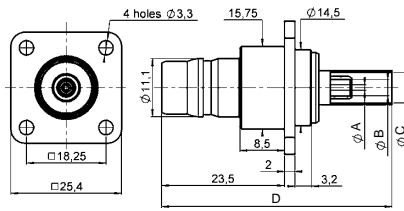

Fig. 1

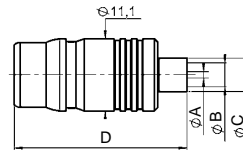

Fig. 2



Cable group	Cable group dia.	Part number	Fig.	Dimensions (mm)				Captive center contact	Packaging	Note
				A	B	C	D			
RG213	10/50/S	R164 286 000	1	2.45	7.46	11.05	46.1	No	50 pieces	25.4 mm square flange crimp type
RG402	.141"	R164 336 000	2	0.97	3.68	5.18	26.6	Yes		Solder type

Jacks and Receptacles

**BULKHEAD STRAIGHT JACKS (panel seal)**

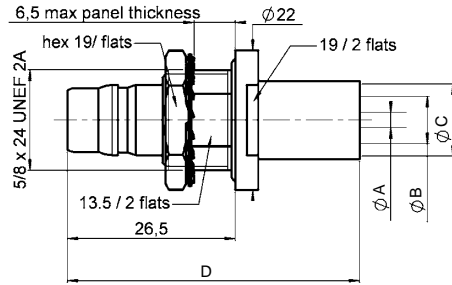

Fig. 1

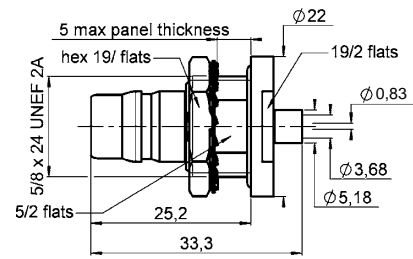
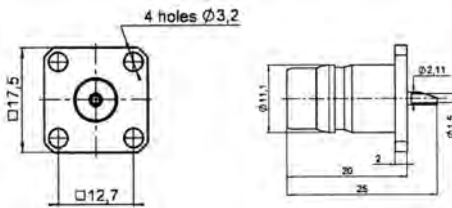

Fig. 2

Cable group	Cable group dia.	Part number	Fig.	Dimensions (mm)				Captive center contact	Panel drilling	Packaging	Note
				A	B	C	D				
RG142 / RG223 / RG400	5/50/D	R164 329 200	1	1.05	3.11	5.8	44.1	No	P03	50 pieces	Rear mount Full crimp type
RG402	.141"	R164 635 002	2	-	-	-	-	Yes			Rear mount Solder type
AEP-400FR	LMR® 400	R164 241 020	3	46.1	2.82	7.46	11.05	Yes	-		Crimp type

**SQUARE FLANGE, STRAIGHT FEMALE RECEPTACLE**



Part number	Captive center contact	Panel drilling	Packaging	Note
R164 418 000	Yes	P01	50 pieces	Solder pot 17.5 square flange

**RECEPTACLES**

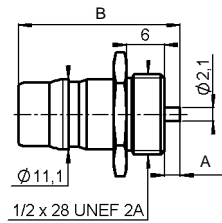

Fig. 1

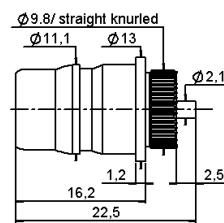
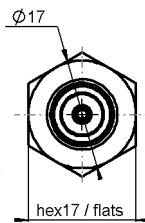

Fig. 2

Part number	Fig.	Dimensions (mm)		Captive center contact	Panel drilling	Packaging	Note
		A	B				
R164 571 027	1	2.5	25.5	Yes	-	50 pieces	Screw-on front mounting
R164 540 027	2	-	-		P02		Press-in

Receptacles and Adapters

**WATERPROOF RECEPTACLES**

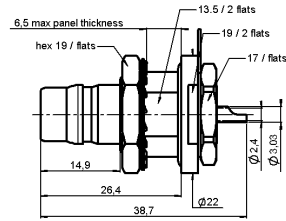

Fig. 1

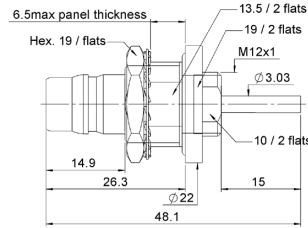

Fig. 2

Part number	Fig.	Captive center contact	Panel drilling	Packaging	Note
R164 606 000	1	Yes	P03	50 pieces	IP68
R164 606 020	2				

**IN SERIES ADAPTERS**

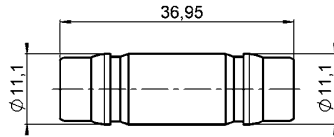

Fig. 1

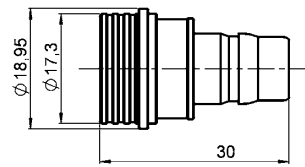

Fig. 2

Part number	Fig.	Captive center contact	Packaging	Note
R164 705 000	1	Yes	50 pieces	QN female - QN female
R164 708 000	2			QN male - QN female

**BETWEEN SERIES ADAPTERS QN/N**

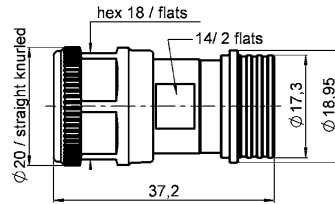

Fig. 1

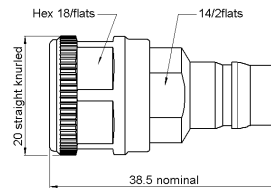

Fig. 2

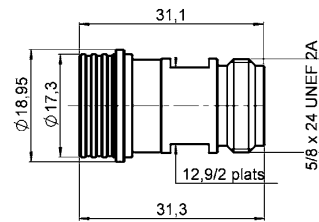

Fig. 3

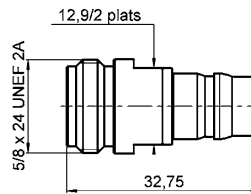
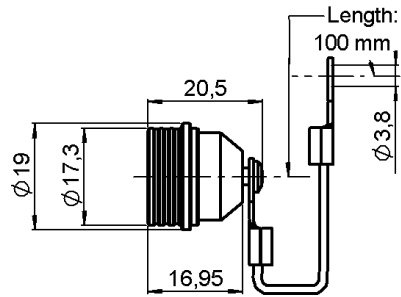

Fig. 4

Part number	Fig.	Captive center contact	Packaging	Note
R191 757 000	1	Yes	Unit	QN male - N male
R191 758 000	2			QN female - N male
R191 759 000	3			QN male - N female
R191 760 000	4			QN female - N female

Protective CAP

PROTECTIVE CAP



Part number	Designation
R164 804 000	Male

Panel Drilling

P01

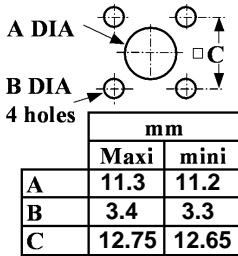

P02

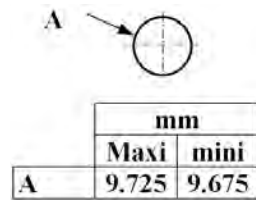

P03

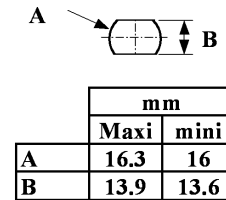

## Introduction

QRE™ is a Quick Lock Ruggedized connector. QRE™ was developed to provide the same advantages as QMA over SMA and designed more for aerospace and defense applications.

QRE™ is made of high grade stainless steel 316L, with Teflon coated fluoro-silicone sealing o-rings which make the QRE™ interface waterproof and ultra resistant to chemical aggression and corrosion. The outer slotted spring contact inspired from the QMA design was reinforced to provide reliable electrical contact during vibration and shock conditions. All QRE™ material were chosen and optimized to operate within the extended temperature range typical in Mil-Aerospace applications. Its superior latching mechanism provides the advantage of a snap-on connector while ensuring a very robust and secure connection. The retention force of the interface is 3 times higher than the QMA. With similar dimensions, QRE™ offers high density integration capabilities like QMA. In addition, a specific tool has been designed to easily disconnect QRE™ plugs on high density applications such as active array radar modules or panels.

A limited range of straight and right angle connectors and receptacles is available for semi-rigid and SHF high frequency flexible cable. New connectors can be quickly developed to fit your own ruggedized coaxial cable. QRE™ cable assemblies can be delivered using our SHF airframe, lightweight or outdoor cables, with or without antiabrasion jacket. Adapters are available for test and measurement in QRE™ to SMA and QRE™ to SMA 3.5 configurations.

## Characteristics

Test / Characteristics	Values / Remarks
<b>ELECTRICAL CHARACTERISTICS</b>	
Impedance	50Ω
Frequency range	DC - 12.4 GHz
V.S.W.R. typical	
• DC - 3 GHz	1.06
• 3 GHz - 6 GHz	1.11
• 6 GHz - 12.4 GHz	1.17
Max insertion loss	0.25
Insulation resistance	5000 MΩ min
Voltage rating	335 Veff max
Dielectric withstanding voltage	1000 Veff min
Admissible power (CW)	450 W @ 1 GHz - 100 W @ 18 GHz
RF leakage	-95 dB min @ 3 GHz -80 dB min @ 12.4 GHz

## MECHANICAL CHARACTERISTICS

Durability	100 matings (500 matings option is available)
Engagement and disengagement forces	65 N typ
Retention force for interface	150 N min
Minimum connector pitch	12.4 mm (distance between center conductors)
Vibration	MIL STD 202 method 204 condition D
Shock	MIL STD 202 method 213 condition I

## ENVIRONMENTAL CHARACTERISTICS

Temperature range	-55/+165°C
IP rating (when mated)	IP 68
Hermeticity (when mated)	10 <sup>-6</sup> atm.cm <sup>3</sup> /s (CEI 68-2-17 Method Qk)

## MATERIALS AND PLATING

	Material	Plating
Connector bodies	Stainless steel 316L	Passivated
Center contacts	Beryllium copper	Gold over Nickel
Outer contact	Beryllium copper	NPGR
Insulators	PTFE	-
O-rings	Fluorosilicone	-

All dimensions are given in mm.

Plugs, Jacks and Receptacle

STRAIGHT AND RIGHT ANGLE PLUGS, SOLDER TYPE

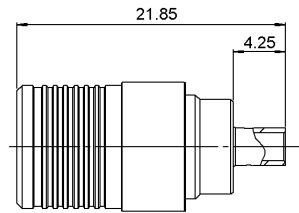

Fig. 1

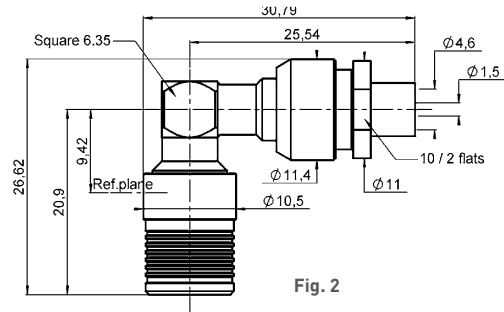

Fig. 2

Cable group	Cable group dia.	Part number	Fig.	Captive center contact	Finish
RG 405	.085"	R324 054 L01	1	No	Passivated
RG 402	.141"	R324 055 L00			
SHF5MAF	Special	R324 195 L02	2		

Note:

For other semi-rigid or flexible cables, please contact us.

STRAIGHT FLANGE JACK SOLDER TYPE FOR SEMI-RIGID CABLE

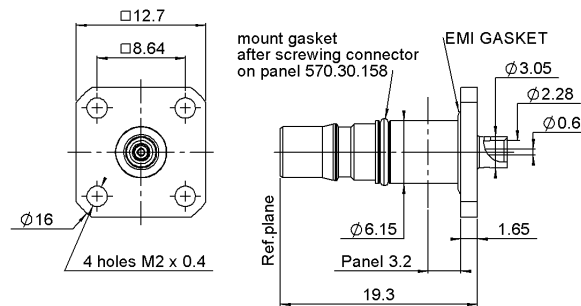

Cable group	Cable group dia.	Part number	Captive center contact	Panel drilling	Finish
RG 405	.085"	R324 256 L01	Yes	P01	Passivated

STRAIGHT FLANGE FEMALE RECEPTACLE

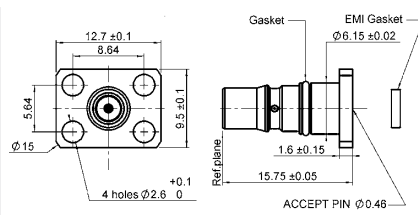

Fig. 1

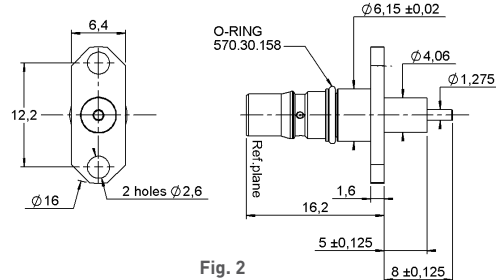

Fig. 2

Part number	Fig.	Captive center contact	Panel drilling	Finish	Note
R324 434 L01	1	Yes	P02	Passivated	EMI Gasket
R324 474 L00	2		P03		-

NOTE:

Replacement O-rings and EMI gaskets available to order, please contact us.



Adapters and Extraction Tool

HERMETIC SCREW-IN FEMALE RECEPTACLE

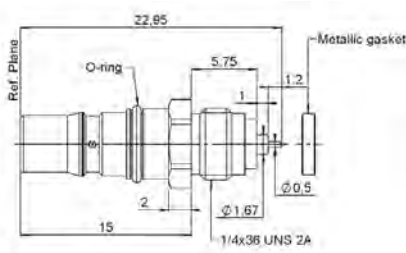

Part number	Captive center contact	Panel drilling	Finish	Note
R324 555 L01	Yes	P04	Passivated	Metallic gasket

BETWEEN SERIES ADAPTERS QRE/SMA

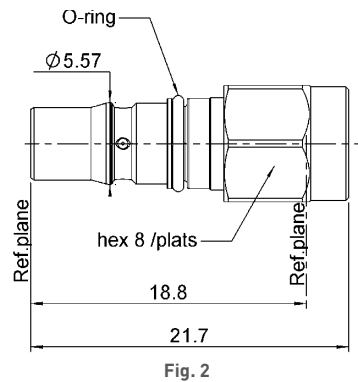
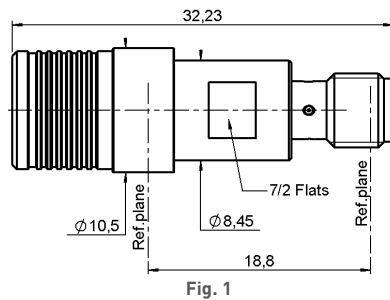

Part number	Fig.	Captive center contact	Finish	Note
R191 926 L01	1	Yes	Passivated	QRE™ male – SMA female
R191 927 L01	2			QRE™ female – SMA male

Note:  
For QRE™ to SMA 3.5 adapters, please contact us.

QRE™ EXTRACTION TOOL

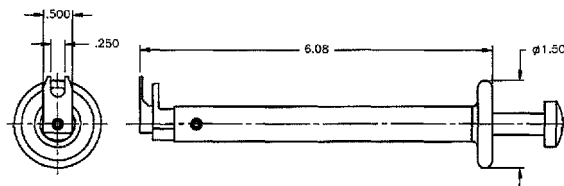

Part number
TA-0457

This tool can be used with either straight or right angle connectors.

Panel Drilling

P01

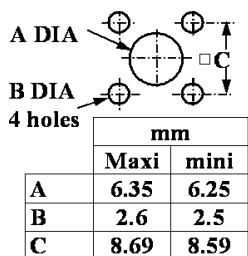

P02

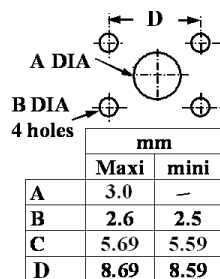

P03

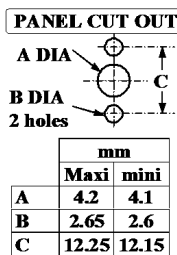

P04



# NOTE





## BNC/BNC 75 HDTV

R141/R142/R266

**Contents**

**BNC**

Introduction ..... 9-4 to 9-5  
Interfaces ..... 9-6 to 9-7  
Characteristics ..... 9-8 to 9-11  
Panel drilling ..... 9-31 to 9-32

**BNC 75 HDTV**

Plugs ..... 9-13  
Jacks ..... 9-14  
Receptacles ..... 9-14  
Adapters ..... 9-15

**BNC 50Ω**

Plugs ..... 9-16 to 9-17  
Jacks ..... 9-18 to 9-19  
Receptacles ..... 9-20 to 9-22  
Adapters ..... 9-23 to 9-24  
Caps ..... 9-24

**BNC 75Ω**

Plugs ..... 9-25 to 9-26  
Jacks ..... 9-26 to 9-27  
Receptacles ..... 9-28  
Adapters ..... 9-29

## Introduction



50Ω	DC - 4 GHz
	DC - 1.5 GHz (commercial)
	DC - 1.0 GHz (Eco)
	DC - 10 GHz (TRIAxIAL)
75Ω	DC - 1.5 GHz
	DC - 6 GHz (HDTV)
	DC - 1.0 GHz (Eco)

**GENERAL**

- Worldwide standardized coaxial connectors
- Bayonet coupling
- Proven strength and reliability
- Good RF performance

**APPLICABLE STANDARDS**

- MIL-C-39012 / MIL STD 348-A/301
- IEC 169-8
- CECC 22120
- NF-C-93564 KBN series
- UTE-C-93564

**APPLICATIONS**

- Civil and military radio-telecommunication equipment
- Test and measurement
- Video communication
- Broadcast
- Industrial network
- General electronics

The BNC connector is the most popular coaxial connector series in the world, featuring a two-pin bayonet coupling system for quick and reliable engagement and disengagement.

- **Wide range:**

Radiall's BNC connectors are available with two characteristic impedances: 50Ω and 75Ω. They are completely intermateable. RADIALL also offers low-cost BNC range, and a triaxial BNC TRX series.

- **Convenient three piece design:**

Straight and right angle crimp type cable connectors feature a three piece design: single piece body + center contact + outer ferrule.



## Interface BNC 75 HDTV

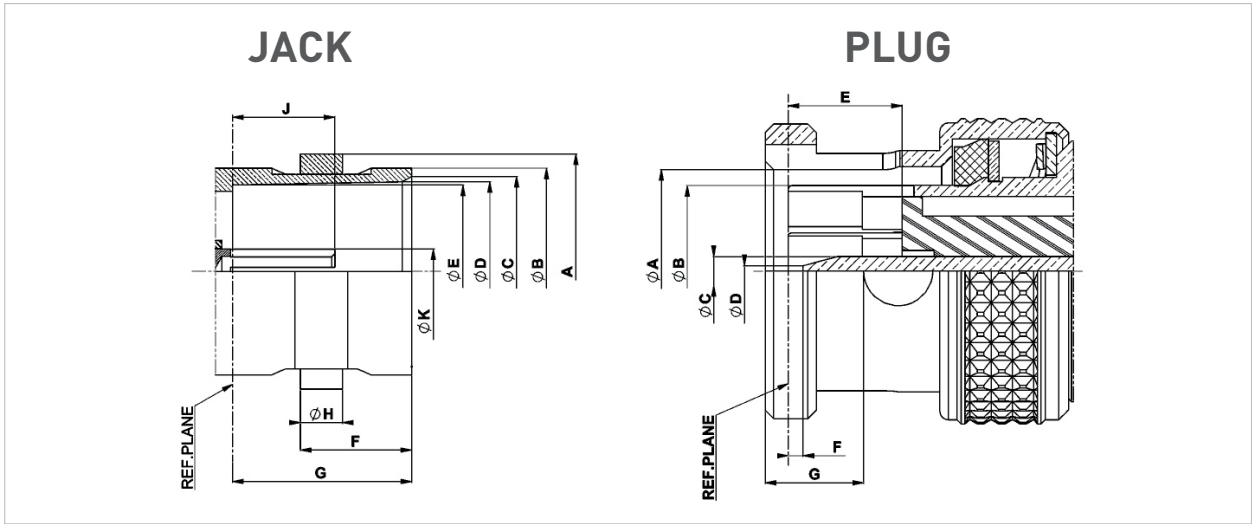

Letter	mm		inch	
	min.	max.	min.	max.
A	10.97	11.07	.432	.436
B	9.60	9.67	.378	.381
C	8.80	9.00	.346	.354
D	8.32	8.46	.328	.333
E	8.10	8.15	.319	.321
F	5.18	5.28	.204	.208
G	8.30	8.50	.327	.335
H	1.90	2.06	.075	.081
J	4.72	5.22	.186	.206
K	2.10	2.14	.083	.084

Letter	mm		inch	
	min.	max.	min.	max.
A	9.80	9.90	.386	.390
B	8.30	8.40	.327	.331
C	1.32	1.37	.052	.054
D	0.35	0.65	.014	.026
E	5.30	5.50	.209	.217
F	0.10	0.90	.004	.035
G	4.57	4.67	.180	.184

## Interface BNC 50Ω

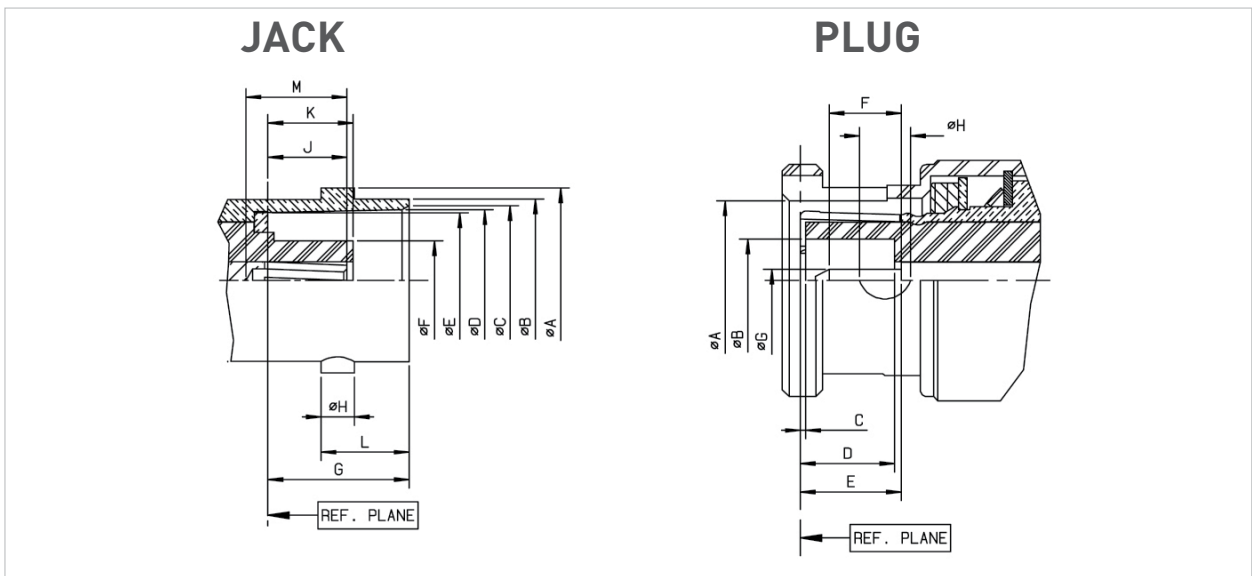

Interface BNC 50Ω

Letter	mm		inch	
	min.	max.	min.	max.
A DIA	10.97	11.07	.432	.436
B DIA	9.60	9.70	.378	.382
C DIA	8.79	9.04	.346	.356
D DIA	8.31	8.46	.327	.333
E DIA	8.10	8.15	.319	.321
F DIA	-	4.72	-	.186
G	8.31	8.51	.327	.335
H	1.91	2.06	.075	.081
J	4.72	5.23	.186	.206
K	4.78	5.28	.188	.208
L	5.18	5.28	.204	.208
M	4.95	-	.195	-

Letter	mm		inch	
	min.	max.	min.	max.
A DIA	9.78	9.91	.385	.390
B DIA	4.83	-	.190	-
C	0.15	-	.006	-
D	5.28	5.79	.208	.228
E	5.33	5.84	.210	.230
F	1.98	-	.078	-
G DIA	1.32	1.37	.052	.054
H DIA	2.31	2.46	.091	.097

Interface BNC 75Ω

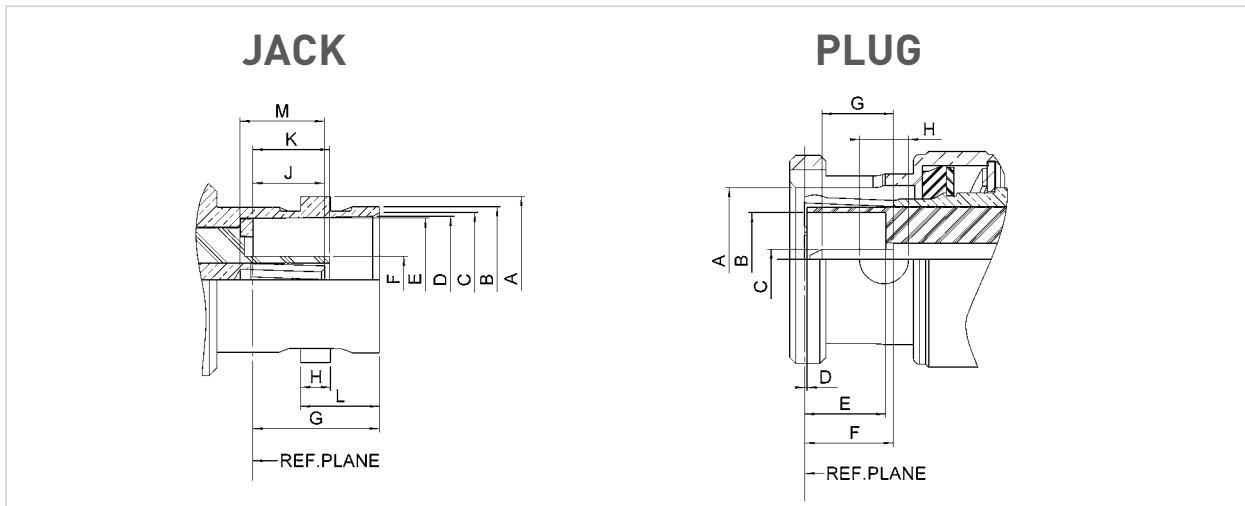

Letter	mm		inch	
	min.	max.	min.	max.
A DIA	10.97	11.07	.432	.436
B DIA	9.60	9.67	.378	.381
C DIA	8.80	9.00	.347	.354
D DIA	8.32	8.46	.328	.333
E DIA	8.10	8.15	.319	.321
F DIA	4.62	4.72	.182	.186
G	8.30	8.50	.326	.334
H	1.90	2.06	.074	.081
J	4.72	5.22	.186	.205
K	4.98	5.23	.196	.206
L	5.18	5.28	.204	.208
M	5.30	5.90	.209	.232

Letter	mm		inch	
	min.	max.	min.	max.
A DIA	9.80	9.90	.386	.389
B DIA	6.10	6.30	.240	.248
C DIA	1.32	1.37	.052	.054
D	0.05	-	.002	-
E	5.42	5.78	.213	.227
F	5.35	5.87	.211	.231
G	3.00	3.40	.118	.134
H DIA	3.15	3.35	.124	.132

## Characteristics

### ELECTRICAL CHARACTERISTICS

Frequency range	DC - 6 GHz (optimized at 3 GHz)		
Impedance	75Ω		
V.S.W.R. (max) • Interface (plug + jack) • Mated pair • In series adapters	DC - 1.5 GHz	1.5 - 3 GHz	3 - 6 GHz
	1.02	1.05	1.08
	1.05	1.12	1.25
	1.04	1.07	1.12
Working voltage	500 Vrms		
Dielectric withstanding voltage	1500 Vrms		
RF Leakage @ 1 GHz	75 dB		
RF Leakage @ 3 GHz	60 dB		
RF Leakage @ 6 GHz	50 dB		

### MECHANICAL CHARACTERISTICS

Mating	Intermateable with 50Ω and 75Ω standard BNC connectors
Long life duration (mating endurance)	1000 cycles
Engagement force	13.6 N
Mating torque (bayonet)	28.6 N.cm
Coupling nut retention force	Axial force: 450 N Bending stress: 1000 N.cm
Center contact insertion force	10 N max
Vibration	MIL STD 202 Meth.204 cond B

### ENVIRONMENTAL CHARACTERISTICS

Temperature range	-65°C + 165°C
Moisture resistance	MIL STD 202, Meth. 106 CECC 22000 paragraph 4.6.6
Corrosion resistance	MIL STD 202, Meth. 101 cond B (48 hours salt spray)

### MATERIALS AND PLATING

Components	Material	Plating
Body	Brass	NPGR / BBR / Nickel
Center contact	Brass or Beryllium copper	NPGR
Outer contact	Brass	NPGR
Insulator	PTFE	-
Gasket	Silicone Rubber	-

## Composite Version

### CHARACTERISTICS

Frequency range	DC up to 6GHz
Impedance	75 Ω
VSWR	1.05 @ 3GHz (Return loss -32dB)
Mating Cycles	1000
Temperature Range	-40 °C ~ + 85 °C

### MATERIAL AND PLATING

Parts	Material	Plating
Coupling Nut	Composite	-
Body	Brass	Gold
Outer contact	Brass	Gold
Center Contact	Brass	Gold
Insulator	PTFE	-



## Characteristics

Test / Characteristics	Standard reference	Values / Remarks
------------------------	--------------------	------------------

**ELECTRICAL CHARACTERISTICS**

Test / Characteristics	Standard reference	Values / Remarks
Impedance		50Ω
Frequency range		DC - 4 GHz
Typical V.S.W.R. • Straight models cable groupe: 2/50, 2.6/50, 5/50, 10 + 11/50, .141" • Right angle models: 2/50, 2.6/50, 5/50	1 GHz 1.12 1.13	2.5 GHz 1.18 1.30 max 1.20 4 GHz 1.22 1.22
Insertion loss • Straight connector • Right-angle connector	0.05 0.08	0.07 0.16 0.13 0.20
RF leakage		-55 dB min from 2 to 3 GHz
Insulation resistance		5000 MΩ min
Contact resistance • Center contact • Outer contact	MIL	1.5 mΩ 0.2 mΩ
Working voltage in VRMS • At sea level (at 21 000m)		500 125
Dielectric withstanding voltage in VRMS • At sea level (at 21 000m)		1500 375
RF testing voltage in VRMS Sea level (5 MHz)		1000

**MECHANICAL CHARACTERISTICS**

Test / Characteristics	Standard reference	Values / Remarks
Durability		500 matings
Force to engage and disengage • Axial • Torque		13.6 N max 28.6 Ncm
Coupling nut retention force		445 N
Cable retention force • Cable 2/50, 2.6/50 • Cable 5/50, 10 + 11/50 • Cable .141"	MIL	227 N
Center contact retention force		27.2 N

**ENVIRONMENTAL CHARACTERISTICS**

Test / Characteristics	Standard reference	Values / Remarks
Temperature range • Flexible cables • Semi-rigid cables		-65°C + 165°C -65°C + 105°C
Thermo cycling test		MIL STD 202, method 107, condition B
Thermal shock		MIL STD 202, method 107, condition B
High temperature endurance		MIL STD 202, method 108
Corrosion salt spray		MIL STD 202, method 101, condition B
Vibration		MIL STD 202, method 204, condition B
Shock		MIL STD 202, method 213, condition G
Moisture resistance		MIL STD 202, method 106
Hermetic test		MIL STD 202, method 112, condition C vacuum 10 <sup>-6</sup> Hgmm (Torr) leakage rate < 10 <sup>-6</sup> atm/cm <sup>3</sup> /s
Barometric pressure		Pressure test: 3.5 bars; duration: 2 mn; temperature: 15°C to 25°C

**MATERIALS AND PLATING**

	Material	Plating
Bodies	Brass	Nickel / BBR
Center contact • Male • Female	Brass Bronze or heat treated beryllium following QQ-C-530	Gold
Nut	Brass	-
Insulator	PTFE	-
Gasket	Silicon Rubber	-

All dimensions are given in mm.

## Characteristics

Test / Characteristics	Standard reference	Values / Remarks
------------------------	--------------------	------------------

## ELECTRICAL CHARACTERISTICS

Impedance	-	75Ω
Frequency range	-	DC - 1.5 GHz
V.S.W.R. max	-	1.30
<ul style="list-style-type: none"> <li>Straight models cable group: 2.6/75, 5/75, 6/75, 8/75, 10 + 11/75</li> <li>Right angle models: 2.6/75, 6/75</li> </ul>		1.35
Insertion loss		0.2 dB max at 1 GHz 0.3 dB max at 1 GHz
<ul style="list-style-type: none"> <li>Straight connector</li> <li>Right-angle connector</li> </ul>		
RF leakage		-55 dB min from 2 to 3 GHz
Insulation resistance		5000 MΩ min
Contact resistance	MIL	1.5 mΩ 0.2 mΩ
<ul style="list-style-type: none"> <li>Center contact</li> <li>Outer contact</li> </ul>		
Working voltage in VRMS		500 125
<ul style="list-style-type: none"> <li>At sea level</li> <li>(at 21 000m)</li> </ul>		
Dielectric withstanding voltage in VRMS		1500 375
<ul style="list-style-type: none"> <li>At sea level</li> <li>(at 21 000m)</li> </ul>		
RF testing voltage in VRMS	Sea level (5 MHz)	1000

## MECHANICAL CHARACTERISTICS

Durability		500 matings
Force to engage and disengage		13.6 N max 28.6 Ncm
<ul style="list-style-type: none"> <li>Axial</li> <li>Torque</li> </ul>	MIL	
Coupling nut retention force		445 N
Cable retention force	Cable 2.6/75, 5/75 6/75, 8/75, 10 + 11/75	340 N
Center contact retention force		27 N

## ENVIRONMENTAL CHARACTERISTICS

Temperature range	flexible cables	-65°C + 165°C
Thermo cycling test		MIL STD 202, method 107, condition B
High temperature endurance		MIL STD 202, method 108
Corrosion salt spray		MIL STD 202, method 101, condition B
Vibration		MIL STD 202, method 204, condition B
Shock		MIL STD 202, method 213, condition G
Moisture resistance		MIL STD 202, method 106
Barometric pressure		Pressure test: 3.5 bars; duration: 2 mn; temperature: 15°C to 25°C

## MATERIALS AND PLATING

	Material	Plating
Bodies	Brass	Nickel
Center contact	Brass	Gold
<ul style="list-style-type: none"> <li>Male</li> <li>Female</li> </ul>	Bronze or heat treated beryllium following QQ-C-530	
Nut	Brass	-
Insulator	PTFE	-
Gasket	Silicone Rubber	-

Standard packaging = 100 pieces

Go online for data sheets &amp; assembly instructions.

Visit [www.radiall.com](http://www.radiall.com) and enter the part number.

## Characteristics

### Commercial version R141 XXX 161 and R142 XXX161

#### ELECTRICAL CHARACTERISTICS

	R141 XXX 161	R142 XXX 161
Impedance	50Ω	75Ω
Operating frequency	DC to 1.5 GHz	
Typical V.S.W.R. (1.5 GHz)		
• Straight models	∅ 2.6	1.21
	∅ 5	1.14
	∅ 6	1.05
• Right angle models	∅ 5 & ∅ 6	1.17
Testing voltage (VRMS)	1500	
Operating voltage (VRMS)	500	
Insulation resistance (MΩ)	5000	
Contact resistance (mΩ)	10	

#### MECHANICAL CHARACTERISTICS

Durability	100 matings
------------	-------------

#### ENVIRONMENTAL CHARACTERISTICS

Temperature range	-40°C + 85°C
-------------------	--------------

#### MATERIALS AND PLATING

	Materials	Platings
Male and female bodies	Brass	Nickel
Coupling nut	Die cast zinc	
Outer contact	Brass	
Insulators	Polypropylene	
Male and female center contacts	Brass	Gold

### ECO version R141A XXX XXX and R142A XXX XXX

#### ELECTRICAL CHARACTERISTICS

	R141A XXX XXX	R142A XXX XXX
Impedance	50Ω	75Ω
Frequency range	DC - 1 GHz	
Typical V.S.W.R. (straight models)	1.3 at 1 GHz	
Temperature range	-40°C / +85°C	
Durability	100 mating cycles	

#### MATERIALS AND PLATING

	Material	Plating
Connector body	Brass / Die cast zinc	Nickel
Insulators	PTFE / Polypropylene	-
Female center contacts	Phosphor bronze	Gold 0.1μm typical (Center contact)

#### PACKAGING

Packaging	100 pieces bulk Unit packaging
-----------	-----------------------------------

Standard packaging = 100 pieces

All dimensions are given in mm.

Plugs

STRAIGHT PLUGS CRIMP TYPE FOR FLEXIBLE CABLES

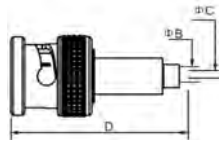

Fig. 1

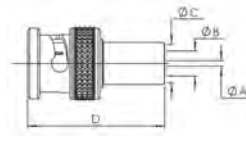
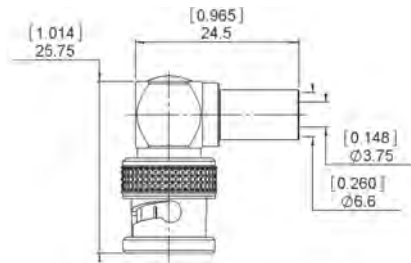

Fig. 2

Cable group	Cable group dia.	Part number	Fig.	Dimensions mm (inch)				Packaging	Note	
				A	B	C	D			
RD179 BELDEN179DT, DRAKA0.31/1.45 AF, CAE HD 03140	0.3/1.4	R142 077 742	1	-	1.55	0.4	29.7	100	-	
Mini RG59 Belden 1855A, Draka 0.6/2.8 AF, CAE HD 0628	0.6/2.8	R142 077 702	2	0.85 (.03)	2.85 (.11)	5.42 (.21)	27.68 (1.09)	100	-	
Mini RG59 Argosy Image 360	0.6/2.95	R142 077 712			3.00 (.12)				-	
RG59 Belden 1505A, Draka 0.8/3.7 AF, CAE HD 08370, Argosy Image 720	0.8/3.7	R142 077 722			3.75 (.15)				6.60 (.26)	26.68 (1.05)
		R142 085 702			0.90	3.95	6.60		28.68	Hexagonal crimp tool 1.73/6.48
RG6 Belden 1694A, Draka 1.0/4.8 AF, CAE HD 10460, Argosy Image 1000	1.0/4.8	R142 077 732			1.05 (.04)	4.85 (.19)	7.50 (.30)		26.68 (1.05)	-
RG11 Belden 7731, Draka 1.6/7.3 AF, CAE HD16720, Argosy Image 2000	1.6/7.3	R142 077 747			1.70	7.45	11.05		32	-

RIGHT ANGLE PLUG CRIMP TYPE FOR FLEXIBLE CABLE



Cable group	Cable group dia.	Part number	Packaging
RG59 Belden 1505A, Draka 0.8/3.7 AF, CAE HD 08370, Argosy Image 720	0.8/3.7	R142 187 720	100

Jacks and Receptacles

**STRAIGHT BULKHEAD JACK CRIMP TYPE FOR FLEXIBLE CABLE**

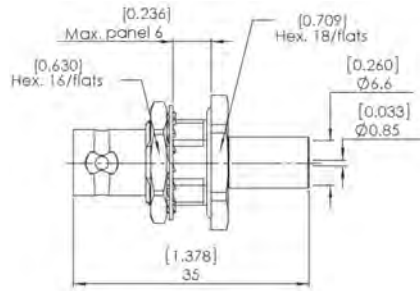

Cable group	Cable group dia.	Part number	Panel drilling	Packaging
RG59 Belden 1505A, Draka 0.8/3.7 AF, CAE HD 08370, Argosy Image 720	0.8/3.7	R142 334 700	P16	100

**PCB FEMALE RECEPTACLES**

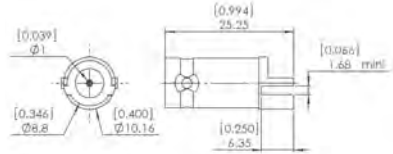

Fig. 1

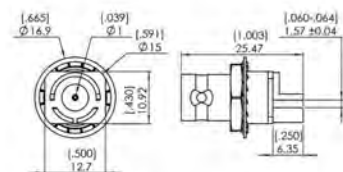

Fig. 2

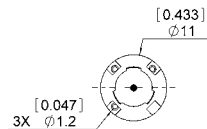
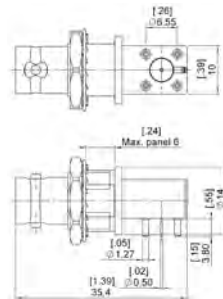

Fig. 3

Part number	Fig.	Captive center contact	Panel drilling	Packaging	Note
R142 568 703	1	Yes	-	100	Edge mount PCB
R142 567 703	2		-		Bulkhead Edge mount PCB
R142 500 740	3		P20	60	Straight PCB, Zamak

**RIGHT ANGLE PCB FEMALE RECEPTACLES**



Part number	Captive center contact	Note
R142 676 700	Yes	Bulkhead

Adapters

IN SERIES ADAPTERS

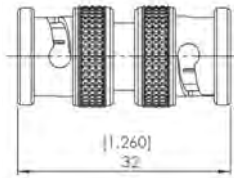

Fig. 1

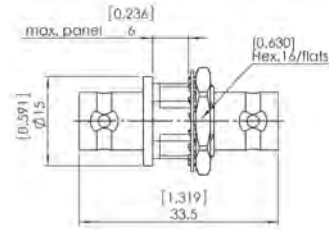

Fig. 2

Part number	Fig.	Captive center contact	Panel drilling	Note	Packaging
R142 703 703	1	Yes	-	Male - Male	100
R142 720 700	2		P16	Female - Female	

BETWEEN SERIES ADAPTERS

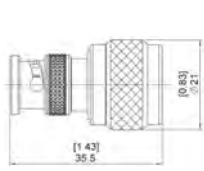

Fig. 1

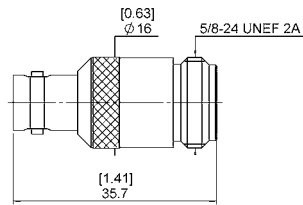
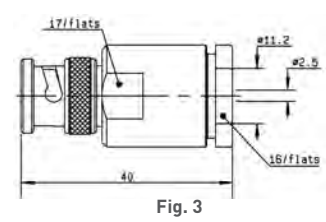
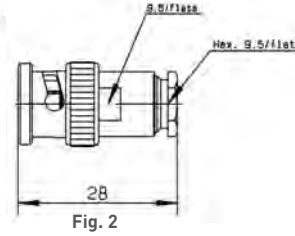
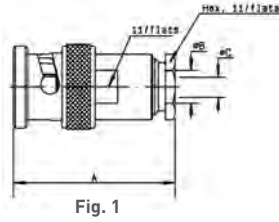

Fig. 2

Part number	Fig.	Captive center contact	Note
R192 417 010	1	Yes	BNC HD male - N male
R192 418 010	2		BNC HD female - N female

Straight Plugs

STRAIGHT PLUGS CLAMP TYPE



Cable group	Cable group dia.	Part number	Fig.	Dimensions (mm)			Captive center contact	Note	
				A	B	C			
RG178 / RG196	2/50/S + D	R141 003 000	1	27	2.2	0.6	Yes	-	
RG174 / RG316 / RD316 / RG179	2.6/50+75/S+D	R141 004 000			3.1			-	
PPD Cable	3.5/50	R141 005 000	2	28	3.7	1.2	No	-	
RG58 / RG141	5/50/S	R141 007 000 R141 007 161						-	-
RG58 / RG141 / RG142 / RG223 / RG400	5/50/S + D	R141 008 000	1	28	5.6	1.2	No	-	
		R141 009 000						1.2	-
		R141 010 000						1.05	Yes
RG59 / RG62	6/75+93	R141 012 000		27.5	6.6	1.05	No	-	
RG213 / RG393 / RG214 / RG216	10 + 11/50/S + D	R141 018 000	3	-	-	-	Yes	-	
RG402	.141"	R141 052 000	1	29	3.65	1.2	No	Semi-rigid cable	

STRAIGHT PLUGS FULL CRIMP TYPE FOR FLEXIBLE CABLES

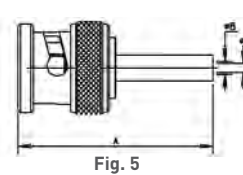
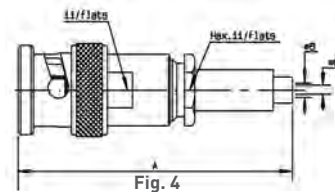
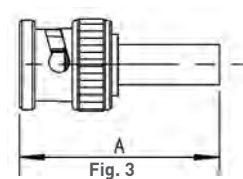
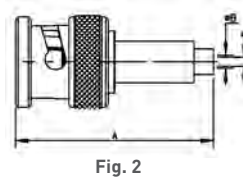
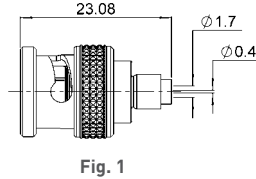

Cable group	Cable group dia.	Part number	Fig.	Dimensions (mm)			Captive center contact	Note		
				A	B	C				
RG178 / RG196	2/50/S	R141 070 520	1	23	1.7	0.4	Yes	Reverse crimp		
RG174 / RG316	2.6/50/S	R141 075 000	2	30.3	1.8	0.6		-		
		R141 075 161						Commercial version		
		R141A 075 161	3	26	1.7	0.6		Single piece body ECO version		
-	3.8/93/S	R141 077 000	2	28	2.7	0.4		-		
RG58 / RG14	5/50/S	R141 072 000	4	39	3.1	-	-			
		R141 082 000	5	28			Single piece body Commercial version			
		R141 082 161	3					30	3.1	1
		R141A 082 161								
RG142 / RG223 / RG400	5/50/D	R141 083 000	5	28	3	1.05	Single piece body			

Right Angle Plugs and Straight Jacks

RIGHT ANGLE PLUGS CLAMP TYPE FOR FLEXIBLE CABLES

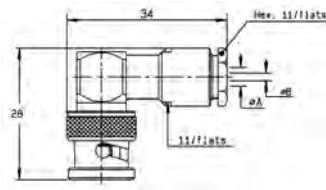

Fig. 1

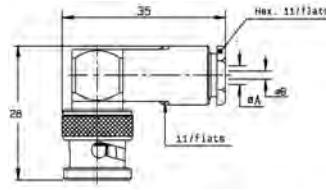

Fig. 2

Cable group	Cable group dia.	Part number	Fig.	Dimensions (mm)		Captive center contact	Note
				A	B		
RG178 / RG196	2/50	R141 153 000	1	2.2	0.6	Yes	100 pieces
RG174 / RG316 / RD316 / RG179	2.6/50+75/S+D	R141 154 000		3.1			
RG58 / RG141 / RG142 / RG223 / RG400	5/50/S + D	R141 156 000	2	5.6	1.05		Unit packaging

RIGHT ANGLE PLUGS FULL CRIMP TYPE FOR FLEXIBLE CABLES

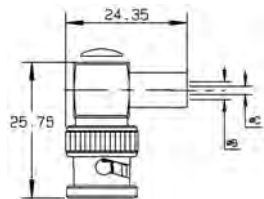

Fig. 1

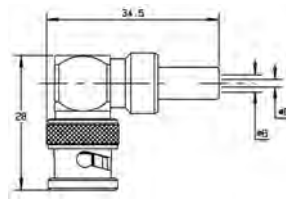

Fig. 2

Cable group	Cable group dia.	Part number	Fig.	Dimensions (mm)		Captive center contact	Note
				B	C		
RG174 / RG316	2.6/50/S	R141 181 161	1	3.25	1.7	Yes	Commercial version
		R141 182 000	2	5.5	1.05		Single piece body
RG58 / RG141	5/50/S	R141 182 161	1	5.5	3.15	Yes	Commercial version
		R141 182 177	2	5.55	3.2		Non magnetic
RG142 / RG223 / RG400	5/50/D	R141 183 000			5.8	1.05	

STRAIGHT JACKS FOR FLEXIBLE CABLES

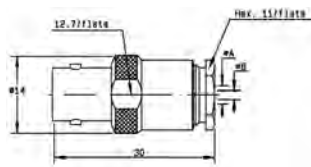

Fig. 1

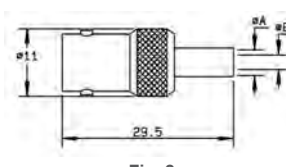

Fig. 2

Cable group	Cable group dia.	Part number	Fig.	Dimensions (mm)		Captive center contact	Note
				A	B		
RG58 / RG141 / RG142 / RG223 / RG400	5/50/S + D	R141 207 000	1	5.6	1.05	No	Clamp type
		R141 208 000					
RG174 / RG316	2.6/50/S	R141 217 000	2	-	0.57	Yes	Full crimp type
RG58 / RG141	5/50/S	R141 237 000		5.5	1.05		Single piece body, full crimp type
		R141 237 161	Commercial version, full crimp type				
RG142 / RG223 / RG400	5/50/D	R141 220 000					Single piece body, full crimp type



Square Flange Jacks

STRAIGHT SQUARE FLANGE JACKS CLAMP TYPE FOR FLEXIBLE CABLES

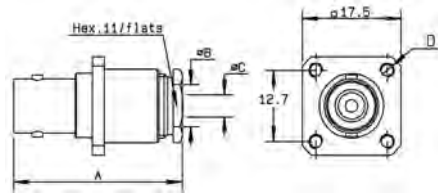

Fig. 1

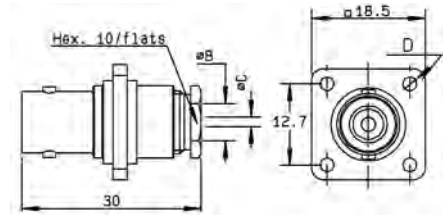

Fig. 2

Cable group	Cable group dia.	Part number	Fig.	Dimensions (mm)				Captive center contact	Panel drilling	Note	
				A	B	C	D				
RG178 / RG196	2/50/S + D	R141 253 000	1	29.5	2.2	0.6	3-56-UNF-2B	Yes	P01	-	
RG174 / RG316 / RD316 / RG179	2.6/50+75/S+D	R141 254 000			3.1					-	
		R141 278 000			2.7					-	
		R141 277 000								2	3
RG58 / RG141	5/50/S	R141 257 000	1	30	5.6	1.05	2.5	No	P01	-	
		R141 256 000	2	-	5.6	1.05	2.6		P02	Insulated flange	
RG58 / RG141 / RG142 / RG223 / RG400	5/50/S + D	R141 258 000	1	30	5.6	1.05	3-56-UNF-2B		No	P01	Unit packaging
RG59	6/75	R141 261 000								30	6.5

STRAIGHT SQUARE FLANGE JACKS FULL CRIMP TYPE FOR FLEXIBLE CABLES

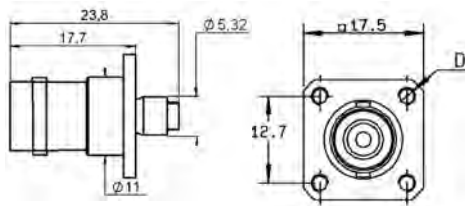

Fig. 1

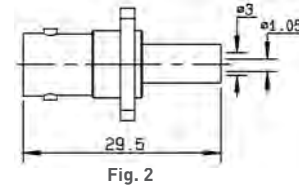

Fig. 2

Cable group	Cable group dia.	Part number	Fig.	Dimensions D (mm)	Captive center contact	Panel drilling	Note
RG174 / RG316	2.6/50	R141 290 200	1	M3 x 0.5	Yes	P04	Reverse crimping, Unit packaging
RG58 / RG141	5/50/S	R141 292 000	2	3 x 56 UNEF 2B		P17	Single piece body

Bulkhead Jacks

STRAIGHT BULKHEAD JACKS CLAMP TYPE

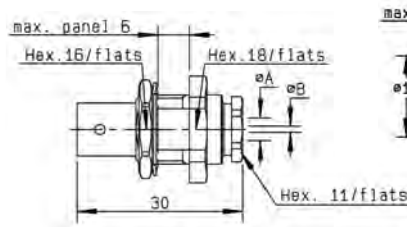

Fig. 1

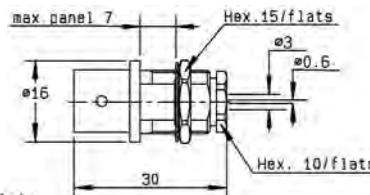

Fig. 2

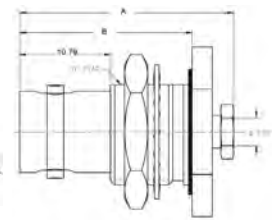

Fig. 3

Cable group	Cable group dia.	Part number	Fig.	Dimensions (mm)		Captive center contact	Panel drilling	Note
				A	B			
RG178 / RG196	2/50/S	R141 323 000	1	2.2	0.6	Yes	P11	Panel sealed
RG174 / RG316 / RD316 / RG179	2.6/50+75/S+D	R141 304 000	2	3.1	0.6			Panel sealed
		R141 324 000	1	3.1	0.6			Totally sealed
RG174 / RG316 / RD316	2.6/50/S + D	R141 324 200	1	5.6	1.05	No		Panel sealed
RG401	.141"	R141 338 007	1	3.68	1.27	Yes		Panel sealed, non magnetic
		R141 338 000		3.65	1.05	No		
RG174 / RG316 / RG179	2.6/50+75S	6501-6571-103	3	27.42	20.98	Yes	P11	Panel sealed
RD316	2.6/50D	6501-7551-219		25.4	20.47			

STRAIGHT BULKHEAD JACKS CRIMP TYPE FOR FLEXIBLE CABLES

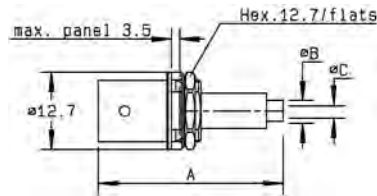

Fig. 1

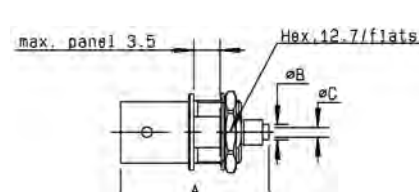

Fig. 2

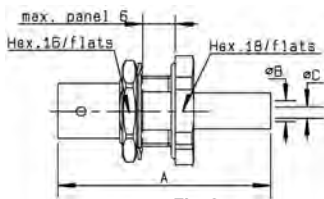

Fig. 3

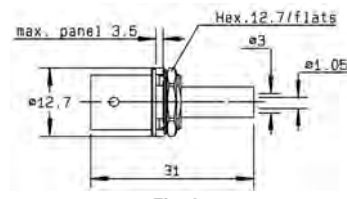

Fig. 4

Cable group	Cable group dia.	Part number	Fig.	Dimensions (mm)			Captive center contact	Panel drilling	Note
				A	B	C			
RG178	2/50S	R141 303 503	2	26.4	2	0.4	Yes	P14	Reverse crimping / commercial version
RD178	2/50D	R141 301 000	1	33.35	1.09	0.6			Reverse crimping / commercial version
RG174 / RG316	2.6/50/S	R141 306 000	1	34	1.7	0.6	No	P11 or P16	Panel sealed
		R141 306 503	2	26	2.95				ECO version
		R141 331 500	3	38.5	1.7	Yes	P11 or P16	Single piece body	
		R141A 306 000	1	31	1.7			Panel sealed single piece body	
RG58 / RG141	5/50/S	R141 308 000	4	-	-	-	Yes	P11 or P16	Panel sealed single piece body
		R141 332 500	3	35.5	3.1	1.05			

Flange Receptacles

FLANGE RECEPTACLES

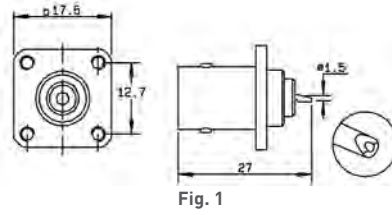

Fig. 1

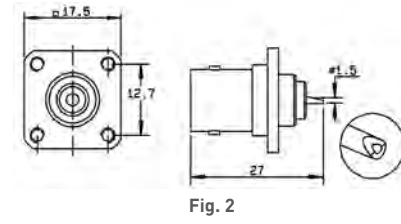

Fig. 2

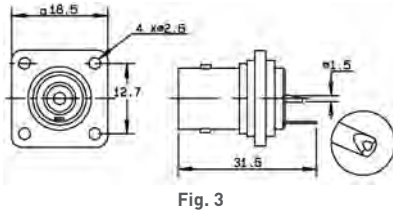

Fig. 3

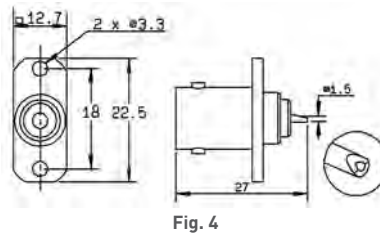

Fig. 4

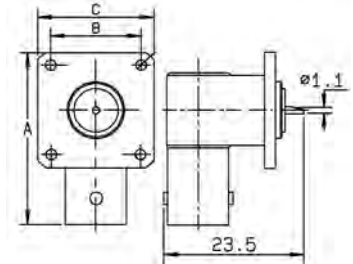
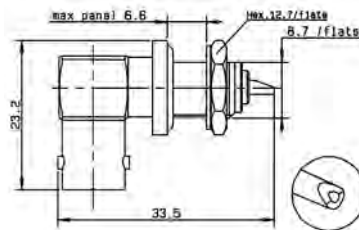

Fig. 5

Part number	Fig.	Dimensions (mm)			Captive center contact	Panel drilling	Flange holes	Note
		A	B	C				
R141 403 000	1	-	-	-	Yes	P07	4 x M2.5	-
R141 404 000	2	-	-	-		P06		-
R141 406 000	1	-	-	-		P07	4 x M2.6	-
R141 407 000	2	-	-	-		P06		-
R141 410 000	3	-	-	-		P02	-	Insulated flange / Solder tag
R141 453 000	4	-	-	-		P18	-	2 hole flange
R141 654 000	5	26.9	12.7	17.5		P05	4 x M2.6	Right angle receptacle

Bulkhead Receptacles

RIGHT ANGLE BULKHEAD RECEPTACLE WITH SOLDER POT



Part number	Captive center contact	Panel drilling
R141 680 000	Yes	P14

Bulkhead Receptacles

BNC 50Ω

STRAIGHT BULKHEAD RECEPTACLES WITH SOLDER POT

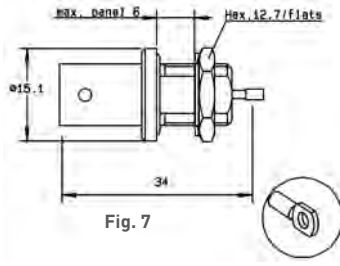
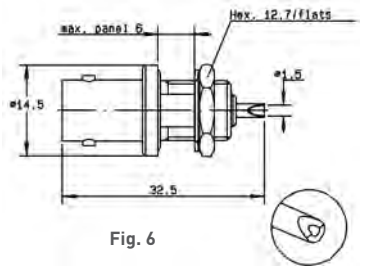
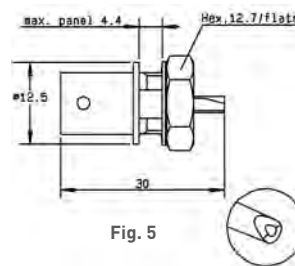
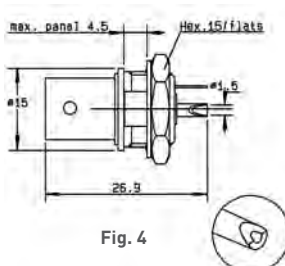
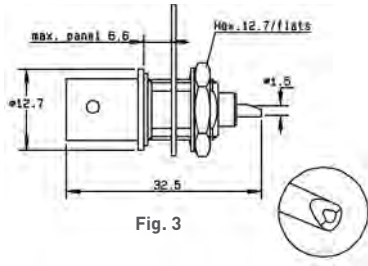
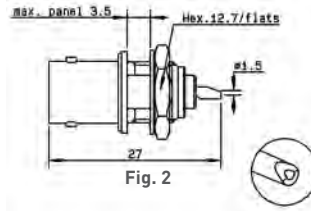
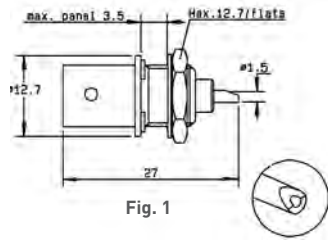

Part number	Fig.	A (Length)	Captive center contact	Panel drilling	Note
R141 554 000	1	-	Yes	P12	-
R141 557 000	2	-		-	
R141 559 000	3	-		P14	Solder tag
R141 563 161	2	-		P14	Silver plated center contact / Commercial version
R141 572 000	4	-		P11	Insulated receptacle + Solder tag
R141 574 000	5	-		P14	Commercial version / Insulated
R141 574 161				P15	Fully sealed / Q200-5 insulator
R141 603 000	6	-		P15	Fully sealed
R141 605 000				P21	Not sealed / ECO version
R141A 605 000	3	28		P14	Hermetically sealed
R141 625 000	7	-		P14	Hermetically sealed

## Receptacles

### RECEPTACLES

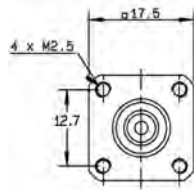

Fig. 1

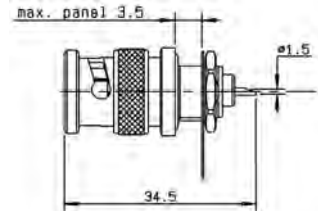
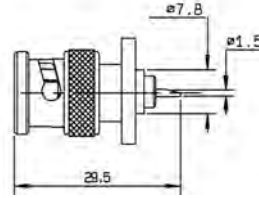

Fig. 2

Part number	Fig.	Captive center contact	Panel drilling	Note
R141 440 000	1	Yes	P03	Male square flange
R141 580 000	2		P14	Male bulkhead / Panel sealed / Solder tag

### STRAIGHT PCB FEMALE RECEPTACLES

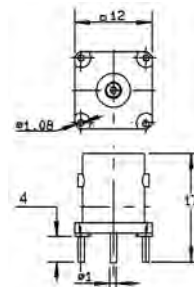

Fig. 1

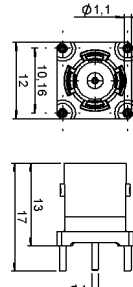

Fig. 2

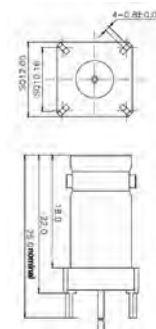

Fig. 3

Part number	Fig.	Captive center contact	Panel drilling	Note
R141 426 000	1	Yes	P08	-
R141 426 161	2			Die cast body / Commercial version
R141 426 168	3	-	-	-

### RIGHT ANGLE PCB FEMALE RECEPTACLES

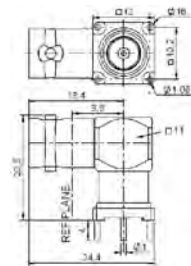

Fig. 1

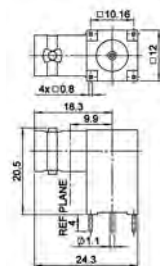
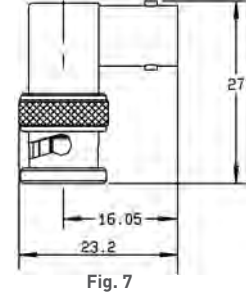
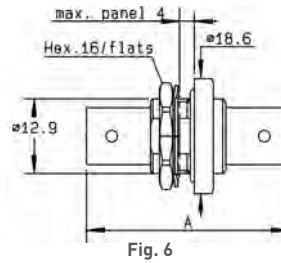
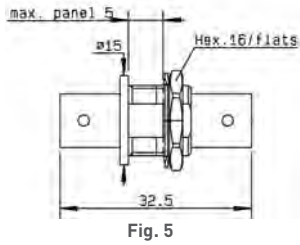
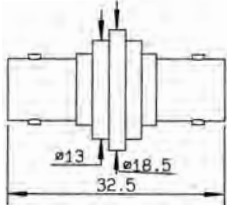
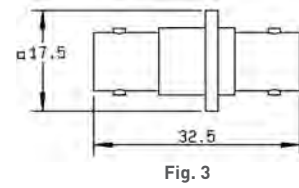
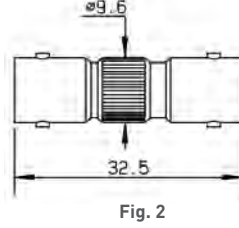
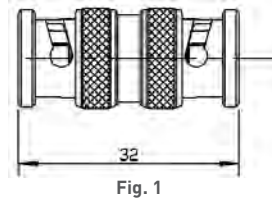

Fig. 2

Part number	Fig.	Captive center contact	Panel drilling	Finish	Note
R141 665 000	1	Yes	P19	Nickel	-
R141 665 200	2		P08		-

Adapters

IN SERIES ADAPTERS



Part number	Fig.	Captive center contact	Dimension A (mm)	Flange holes	Panel drilling	Note
R141 703 000	1	Yes	-	-	-	Male - Male
R141 704 000	2		-	-	-	Female - Female
R141 710 000	3		-	4 x M2.5	P10	Female - Female square flange
R141 717 000	4		-	4 x 2.6	P02	Female - Female square insulated flange
R141 720 000	5		-	-	P13	Female - Female bulkhead
R141A 720 000			-	-		Female - Female bulkhead / ECO version
R141 723 000			-	-	P13 or P16	Female - Female insulated bulkhead
R141 723 161			-	-		Female - Female insulated bulkhead / Commercial version
R141 730 000	6		-	35.7	P13	Female - Female panel sealed bulkhead
R141 753 000			-	35.3		Female - Female hermetically sealed bulkhead
R141 770 000	7	-	-	-	-	Male - Female right angle

Adapters and Caps

CROSS AND TEE IN SERIES ADAPTERS

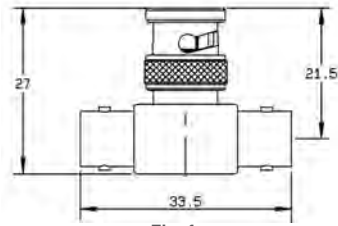

Fig. 1

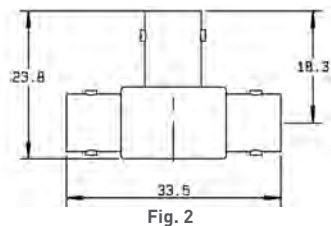

Fig. 2

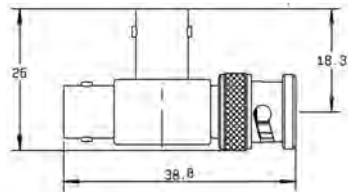

Fig. 3

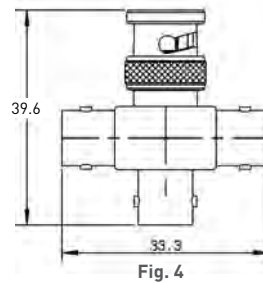

Fig. 4

Part number	Fig.	Captive center contact	Note
R141 780 000	1	Yes	Male / Female - Female tee
R141 782 000	2		Female / Female - Female tee
R141 789 000	3		Female / Female - Male tee
R141 799 000	4		Male / Female - Female - Female cross / Unit packaging

MALE AND FEMALE CAPS

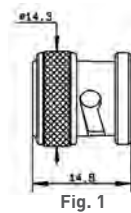

Fig. 1



Fig. 2

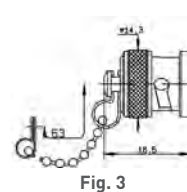

Fig. 3

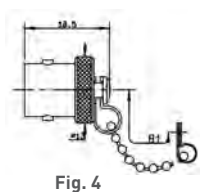

Fig. 4



Part number	Fig.	Note
R141 802 000	1	Male
R141 805 000	2	Male with cord
R141 812 000	3	Male with chain
R141 842 000	4	Female with chain
R141 862 000	3	Male short circuit / With chain



Straight Plugs

STRAIGHT PLUGS CLAMP TYPE FOR FLEXIBLE CABLES

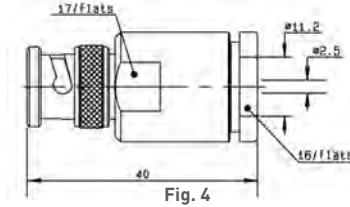
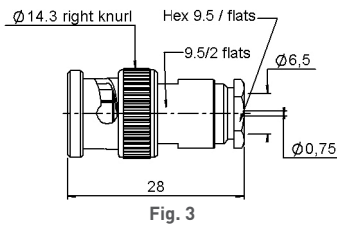
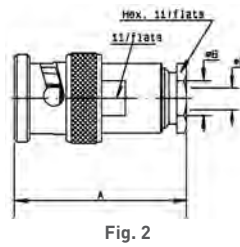
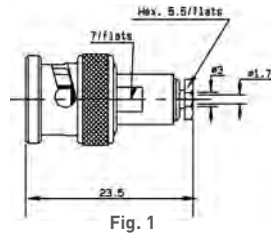

Cable group	Cable group dia.	Part number	Fig.	Dimensions (mm)			Captive center contact	Note
				A	B	C		
RG179	2.6/75/S	R142 004 000	1	-	-	-	Yes	-
RG59 / RG62	6/75/S	R142 016 000	2	28	6.6	0.75		-
		R142 016 161	3	-	-	-	Commercial version	
RG6A / U	8/75/S + D	R142 017 000	2	45.5	9.1	1.5	Yes	Unit packaging
RG216 / RG11 / RG12 / RG144	10 + 11/75/S + D	R142 018 000	4	-	-	-		-
RG6A / U	GORE cable	6500-7071-046	2	23.87	4.31	2.79		-

STRAIGHT PLUGS FULL CRIMP TYPE FOR FLEXIBLE CABLES

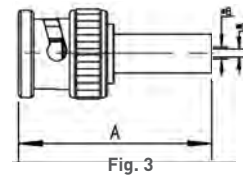
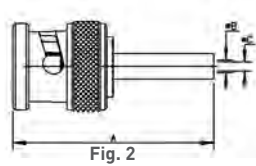
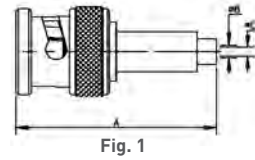

Cable group	Cable group dia.	Part number	Fig.	Dimensions (mm)			Captive center contact	Note
				A	B	C		
RG179	2.6/75/S	R142 076 000	1	31	1.8	0.4	Yes	-
		R142 076 161	3					Commercial version
		R142A 076 161						No
BT3002	3.6/75/D	R142 081 120	2	29	2.1	0.34	-	Single piece body
		R142 081 130		29	2.1	0.34		Single piece body / Unit packaging
		R142A 081 130		29	2.1	0.34		Single piece body / ECO version
ST212	-	R142 091 161	3	30	2.1	0.6	Yes	-
BT2002	5/75/D	R142 083 000	2	27.3	5.5	0.75	-	Single piece body
RG59 / RG62	6/75/S	R142 085 000		28	6.6			No
		R142 085 161	28	3.9	Single piece body / ECO version			
		R142A 085 161	29	4	0.8	Single piece body / Commercial version		
-	7/75/S	R142 086 161	2	30.8	5.15	1.35	Yes	Single piece body / Commercial version
-	7.5/75/D	R142 090 000		28	5.25	0.85		Single piece body
RG11 / RG12 / RG144	10/75/S	R142 095 000	2	28	11.05	1.35	-	Single piece body



## Right Angle Plugs and Jacks

### RIGHT ANGLE PLUGS CLAMP TYPE FOR FLEXIBLE CABLES

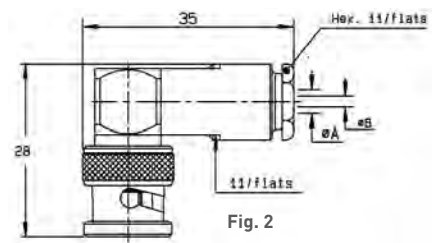
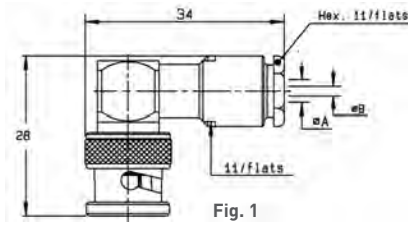

Cable group	Cable group dia.	Part number	Fig.	Dimensions (mm)		Captive center contact
				A	B	
RG179	2.6/75/S	R142 154 000	1	3.1	0.6	Yes
RG59 / RG62	6/75/S	R142 157 000	2	6.6	0.75	

### RIGHT ANGLE PLUGS FULL CRIMP TYPE FOR FLEXIBLE CABLES

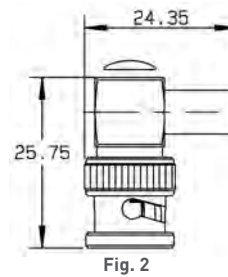
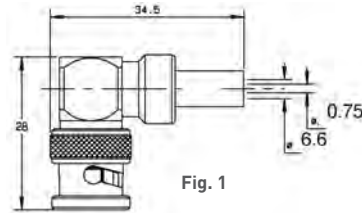

Cable group	Cable group dia.	Part number	Fig.	Captive center contact	Note
RG59 / RG62	6/75/S	R142 184 000	1	Yes	-
		R142 184 161	2		Commercial version

### STRAIGHT JACKS FULL CRIMP TYPE FOR FLEXIBLE CABLES

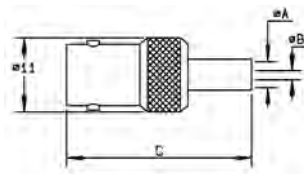

Cable group	Cable group dia.	Part number	Dimensions (mm)			Captive center contact	Note
			A	B	C		
RG179	2.6/75/S	R142 217 000	1.75	0.4	32.5	Yes	-
RG59 / RG62	6/75/S	R142 242 000	6.6	0.75	29.5		Single piece body
		R142 242 161			29		Single piece body / commercial version

Jacks and Bulkhead Jacks

**STRAIGHT SQUARE FLANGE JACKS CLAMP TYPE FOR FLEXIBLE CABLES**

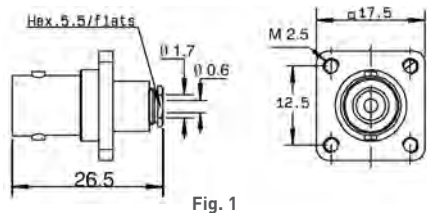

Fig. 1

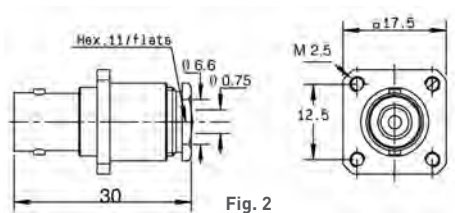
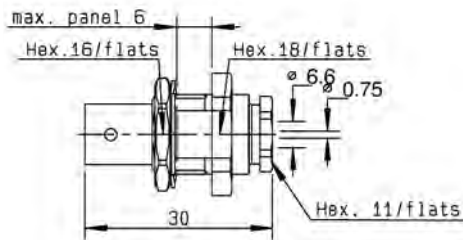

Fig. 2

Cable group	Cable group dia.	Part number	Fig.	Captive center contact	Panel drilling	Note
RG179	2.6/75/S	R142 202 000	1	Yes	P01	Unit packaging
RG59 / RG62	6/75/S	R142 268 000	2			

**STRAIGHT BULKHEAD JACK CLAMP TYPE FOR FLEXIBLE CABLES**



Cable group	Cable group dia.	Part number	Captive center contact	Panel drilling	Note
RG59 / RG62	6/75/S	R142 329 000	Yes	P11	Panel sealed

**STRAIGHT BULKHEAD JACKS CRIMP TYPE FOR FLEXIBLE CABLES**

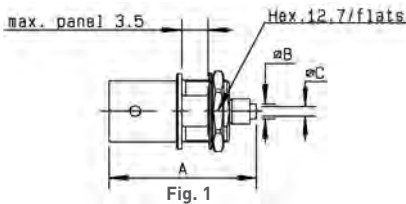

Fig. 1

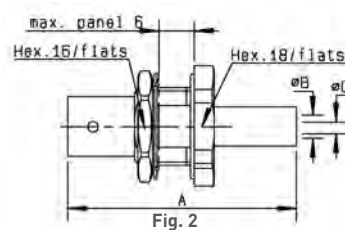

Fig. 2

Cable group	Cable group dia.	Part number	Fig.	Dimensions (mm)			Captive center contact	Panel drilling	Note			
				A	B	C						
RG179	2.6/75/S	R142 306 500	1	26	2.95	0.4	Yes	P14	Reverse crimping / Commercial version			
		R142A 306 500					No		Reverse crimping / ECO version			
		R142 306 503					Yes		Reverse crimping			
		R142 331 011										
BT3002	3.6/75/D	R142A 325 106	2	36	2.1	0.5	No	P11 or P16	Panel sealed / Silver plated			
RG59 / RG62	6/75/S	R142 334 161					Yes		35	6.6	0.75	Panel sealed / Commercial version
		R142A 334 161					Yes		35	3.8	0.7	Panel sealed / ECO version

Receptacles

RECEPTACLES WITH SOLDER POT

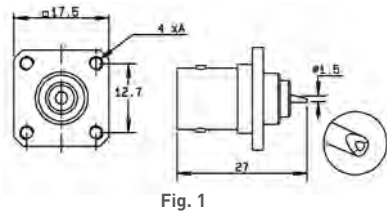
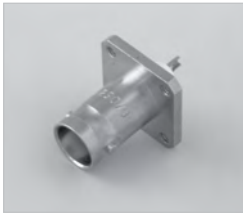

Fig. 1

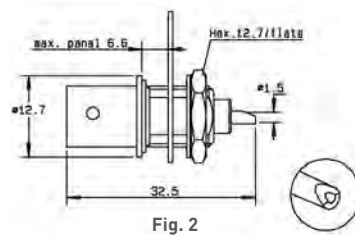
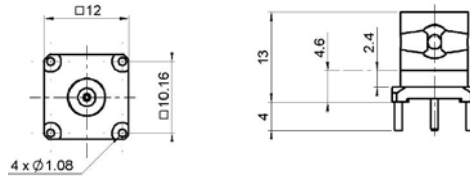

Fig. 2



Part number	Fig.	Captive center contact	Panel drilling	Flange holes A	Note
R142 412 000	1	Yes	P06	4 x M2.5	Square flange + Unit packaging
R142 562 000	2		P14	-	Bulkhead female receptacle Unit packaging

STRAIGHT PCB FEMALE RECEPTACLES



Part number	Captive center contact	Panel drilling
R142 426 000	Yes	P08

RIGHT ANGLE PCB FEMALE RECEPTACLE

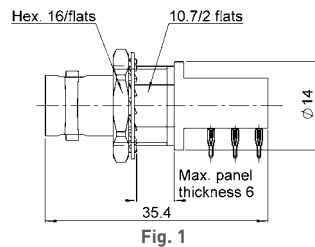

Fig. 1

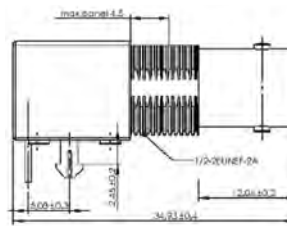

Fig. 2

Part number	Fig.	Captive center contact	Panel drilling	Note
R142 684 130	1	Yes	P09 and P16	Press-fit pins
R142 676 430	2		Yes	Harpoon legs

Adapters

IN SERIES ADAPTERS

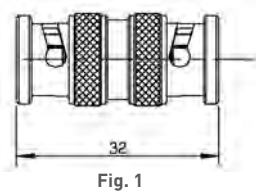

Fig. 1

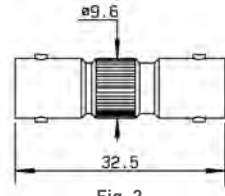

Fig. 2

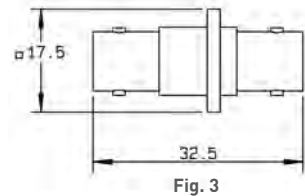

Fig. 3

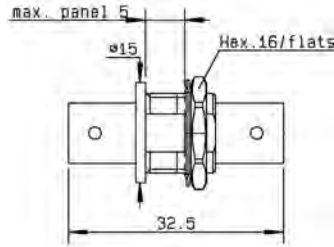

Fig. 4

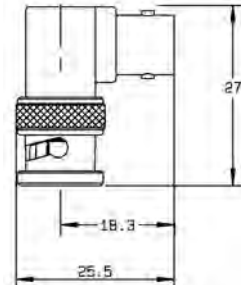

Fig. 5

Part number	Fig.	Captive center contact	Panel drilling	Note
R142 703 000	1	Yes	-	Male - Male
R142 704 000	2		-	Female - Female
R142 710 000	3		P01	Female - Female square flange
R142 720 000	4		P11	Female - Female bulkhead
R142 723 000	4		P11 or P16	Female - Female insulated bulkhead
R142 770 000	5		-	Male - Female right angle

TEE IN SERIES ADAPTERS

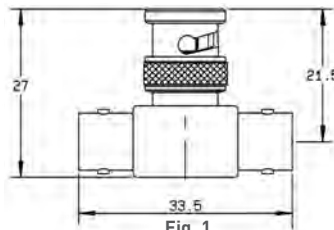

Fig. 1

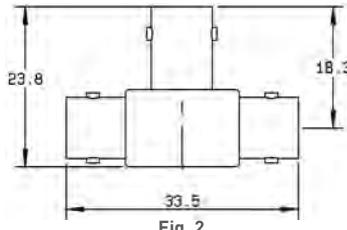

Fig. 2

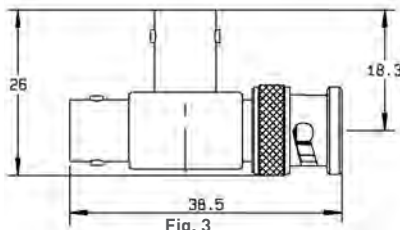
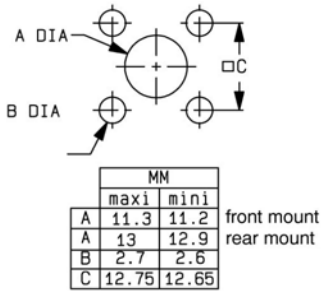

Fig. 3

Part number	Fig.	Captive center contact	Note
R142 780 000	1	Yes	Male / Female - Female tee
R142 782 000	2		Female / Female - Female tee
R142 789 000	3		Female / Female - Male tee

Panel Drilling

P01



P02

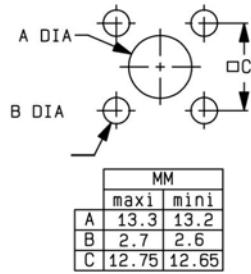

P03

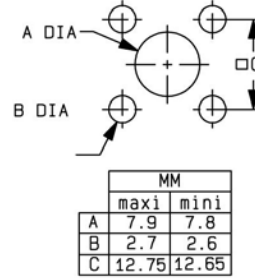

P04

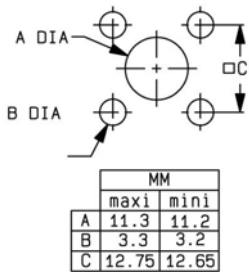

P05

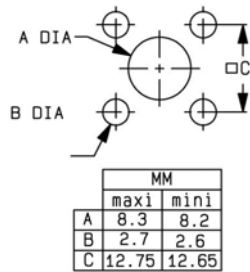

P06

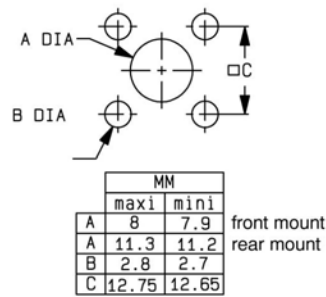

P07

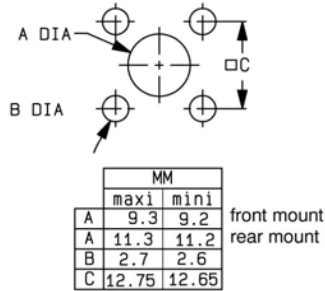

P08

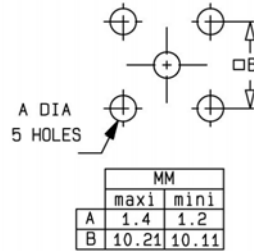

P09

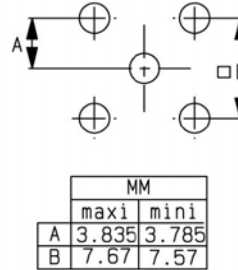

P10

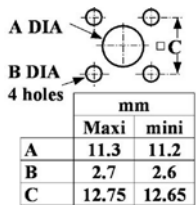

P11

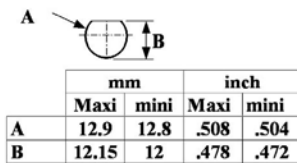

P12

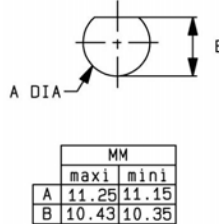

## Panel Drilling

**P13**

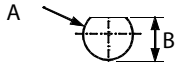

mm		
	Maxi	mini
A	12.9	12.8
B	12.04	11.94

**P14**

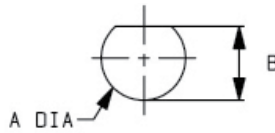

MM		
	maxi	mini
A	9.7	9.6
B	8.9	8.8

**P15**

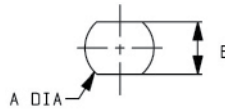

MM		
	maxi	mini
A	9.75	9.65
B	8.65	8.55

**P16**

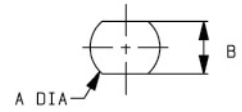

MM		
	maxi	mini
A	12.8	12.7
B	10.9	10.8

**P17**

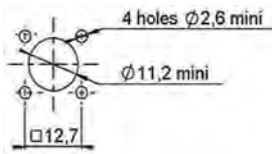

**P18**

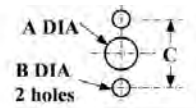

mm		
	Maxi	mini
A (F. Mount)	9	8.9
A (R. Mount)	11.3	11.2
B	3.4	3.3
C	18.1	18

**P19**

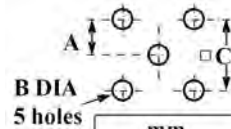

mm		
	Maxi	mini
A	5.105	5.055
B	1.4	1.2
C	10.21	10.11

**P20**

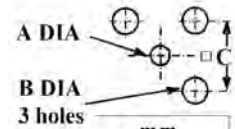

mm		
	Maxi	mini
A	1.15	1.05
B	2.26	2.16
C	6.96	6.76

**P21**

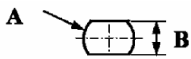

mm		
	Maxi	mini
A	10.2	10.0
B	9.3	9.2



## HIGH FREQUENCY CONNECTORS: N 18 GHZ TNC 18 GHZ/SMA 2.9/2.4 MM

*R163/R143/R127/R327*

**Contents****N 18 GHz**

Introduction.....	10-4 to 10-5
Interface .....	10-6
Characteristics .....	10-7
Plugs and jacks.....	10-8
Adapters .....	10-8

**TNC 18 GHz**

Interface .....	10-9
Characteristics .....	10-10
Plugs .....	10-11
Jacks .....	10-11 to 10-12
Receptacles.....	10-12
Adapters .....	10-13
Caps .....	10-13

**SMA 2.9**

Introduction.....	10-14
Interface .....	10-15
Characteristics and plugs .....	10-16
Jacks and receptacles .....	10-17
Glass bead .....	10-18
In series adapters .....	10-18
Between series adapters .....	10-19
Panel drilling .....	10-19

**2.4 MM**

Interface .....	10-20
Characteristics .....	10-21
Plugs, jacks and receptacles .....	10-22 to 10-23
Glass bead .....	10-23
In series adapters .....	10-24
Panel drilling .....	10-24



**Introduction**

N 18 connectors are 50 ohm precision N Type connectors designed to perform through 18 GHz. N connectors are a popular medium sized option commonly used in microwave and RF applications that require high power handling and good electrical performance. Radiall Type N connector interfaces utilizes a PTFE (Teflon) dielectric. The male connectors are provided with a 19 mm (3/4 in.) hex coupling nut so they can be properly torqued. Connector bodies are made from stainless steel, and contacts are made from gold plated and heat treated beryllium copper contacts to insure long life and reliability.

Radiall offers N connectors for semi-rigid and low loss flexible cables, receptacles and precision adapters.

Connectors for low loss flexible cables and TestPro cables are not detailed in this section. They are available in our cable assembly offer.

**TYPE N 18 DESIGN FEATURES:**

- Excellent performance up to 18 GHz
- Low VSWR and insertion loss
- Highly robust construction for reliability
- Superior interface environmental seal
- High power capability

Interface

N 18 GHz

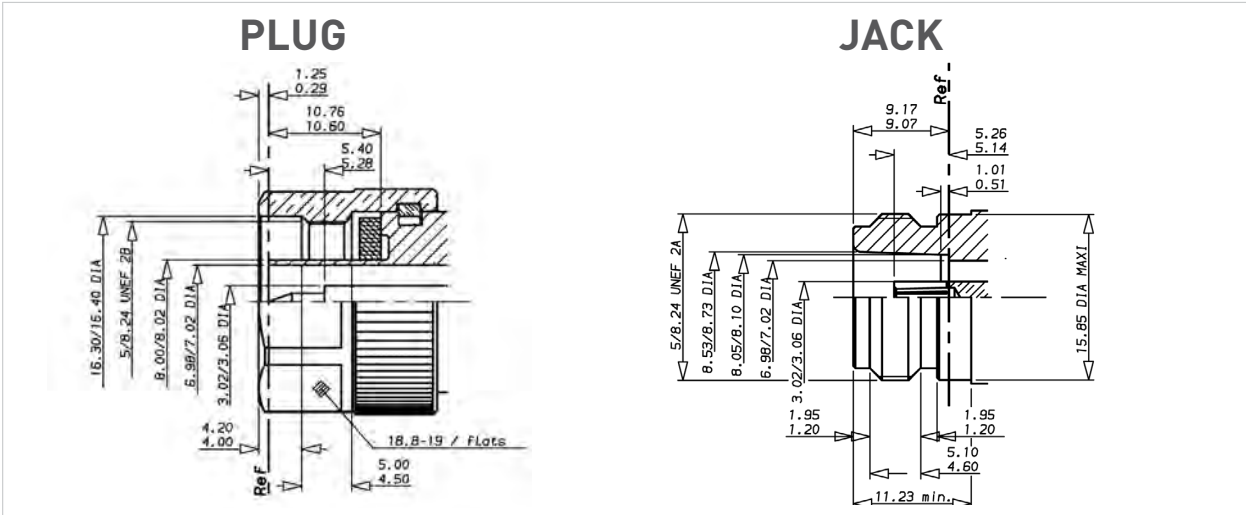

**IMPORTANT:** the **50Ω** and the **75Ω** connectors are **NOT INTERMATEABLE**, results in the **interface destruction**.

mm	inch
0.29	.0114
1.25	.049
3.02	.1189
3.06	.1204
4.00	.157
4.20	.165
4.50	.177
5.00	.197
5.28	.208
5.40	.2126
6.98	.2748
7.02	.2764
8.00	.315
8.02	.316
10.60	.417
10.76	.423
16.30	.642
16.40	.646
18.80	.740
19.00	.748

mm	inch
0.51	.020
1.01	.0397
1.20	.0472
1.95	.0767
3.02	.1189
3.06	.1204
4.60	.1811
5.10	.201
5.14	.202
5.26	.207
6.98	.2748
7.02	.2764
8.05	.317
8.10	.319
8.53	.336
8.73	.3437
9.07	.357
9.17	.361
11.23	.442
15.85	.624

Mating dimensions are MIL-C-39012 nominal with tighter tolerances and solid outer contact.

## Characteristics

Test/Characteristics	Values/Remarks
----------------------	----------------

## ELECTRICAL CHARACTERISTICS

Impedance	50Ω	
Frequency range	DC - 18 GHz	
Typical V.S.W.R. • Straight connector • Right angle connector	With SHF cables 1.10 at 18 GHz 1.15 at 18 GHz	
Insertion loss	< 0.1 √F [GHz] dB	
RF Leakage	- 90 dB (2 to 3 GHz)	
Insulation resistance	5000 MΩ min	
Contact resistance • Outer contact • Inner contact	After environment test 2 mΩ max N.A.	Initial 1.5 mΩ max 2 mΩ max
Peak power (at sea level)	5000 W	
Average power (at sea level, 25°C)	2000 W at 0.1 GHz 600 W at 1 GHz 150 W at 10 GHz	
	.085" semi-rigid cable	.141" semi-rigid cable
Dielectric withstanding voltage • At sea level • At 70 000 feet	1000 Vrms 250 Vrms	1500 Vrms 375 Vrms
Voltage rating • At sea level • At 70 000 feet	335 Vrms 85 Vrms	500 Vrms 125 Vrms
RF high potential withstanding voltage	670 Vrms	1000 Vrms
Corona level	250 Vrms	375 Vrms

## MECHANICAL CHARACTERISTICS

Durability	500 matings	
Cable retention force	136 N (31 lbf)	272 N (61 lbf)
Recommended coupling torque	160 Ncm (14 lbf.in)	
Contact captivation	27 Ncm (6 lbf) min	

## ENVIRONMENTAL CHARACTERISTICS

Temperature range	Standard connectors - 65°C + 165°C	Connectors for semi-rigid cable - 40°C + 125°C
Vibration	MIL-STD-1344 Method 2005 Condition 4	
Shock	MIL-STD-1344 Method 2004 Condition G	
Thermal shock	MIL-STD-1344 Method 1003 Condition A	
Corrosion (salt mist)	MIL-STD-1344 Method 1001 Condition B	
High temperature test	CECC 22000/4.7.2	
Damp heat	CECC 22000/4.6.6	
Low pressure immersion	EN2591 AECMA TestC14	
Resistance to fluids contamination	EN2591 AECMA TestC15	

## MATERIALS

Body	Stainless steel
Center contact	Beryllium copper and brass
Coupling nut	Brass
Insulator	PTFE or polyetherimid resin
Gasket	Fluorosilicon or fluorocarbon

## PLATING

Body	Passivated
Center contact	Gold
Coupling nut	Nickel

Plugs, Jacks and Adapters

**STRAIGHT PLUGS FOR SEMI-RIGID CABLES**

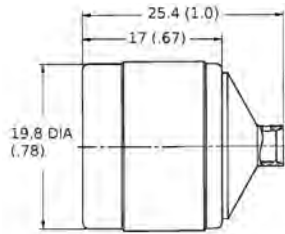

Cable group	Cable group dia.	Part number	Captive center contact	Material	Note
RG402	.141"	4000-1563-009	Yes	Stainless steel	Direct solder
RG405	.085"	4000-1563-010			

**Note:**  
N18 GHz plugs for SHF high frequency flexible cable are available as cable assemblies only. Consult us for standard N18 GHz cable assembly part numbers.

**BULKHEAD STRAIGHT JACKS, FOR SEMI-RIGID CABLES (panel sealed)**

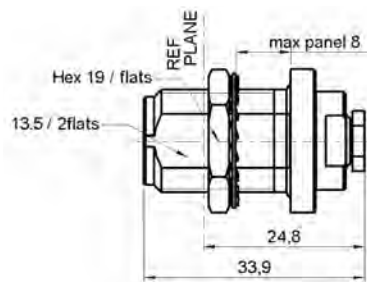

Cable group	Cable group dia.	Part number	Captive center contact	Panel drilling	Material	Note
RG405	.085"	4501-9543-010	Yes	P14	Stainless steel	Solder clamp / Rear mount
RG402	.141"	4501-9543-009				
		R163 337 001				

**IN SERIES ADAPTERS**



Fig. 1

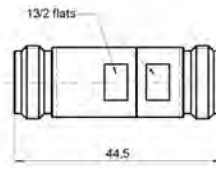

Fig. 2

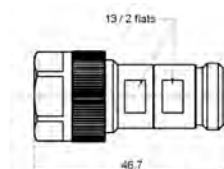

Fig. 3

Part number	Fig.	Dimension (mm)	Note
R163 703 001	1	53.5 (2.106)	Male - Male
R163 705 001	2	44.5 (1.752)	Female - Female
R163 708 001	3	46.7 (1.838)	Male - Female

**Note:**  
7mm air line adapters also available upon request.

## Introduction

TNC 18 connectors are 50 ohm precision TNC Type connectors designed to perform through 18 GHz. TNC connectors are a popular medium sized option commonly used in microwave and RF applications that require average power handling and good electrical performance. Radial TNC connector interfaces utilizes a PTFE (Teflon) dielectric. The male connectors are provided with a 14 mm (9/16 in.) hex coupling nut so they can be properly torqued. Connector bodies are made from stainless steel, and contacts are made from gold plated and heat treated beryllium copper contacts to insure long life and reliability.

Radial offers TNC connectors for semi-rigid and low loss flexible cables, receptacles and precision adapters.

Connectors for low loss flexible cables and TestPro cables are not detailed in this section. They are available in our cable assembly offer.

## TNC 18 DESIGN FEATURES

- Excellent performance up to 18 GHz
- Low VSWR and insertion loss
- Rugged construction for reliability
- Superior interface environmental seal
- Medium power capability

## Interface

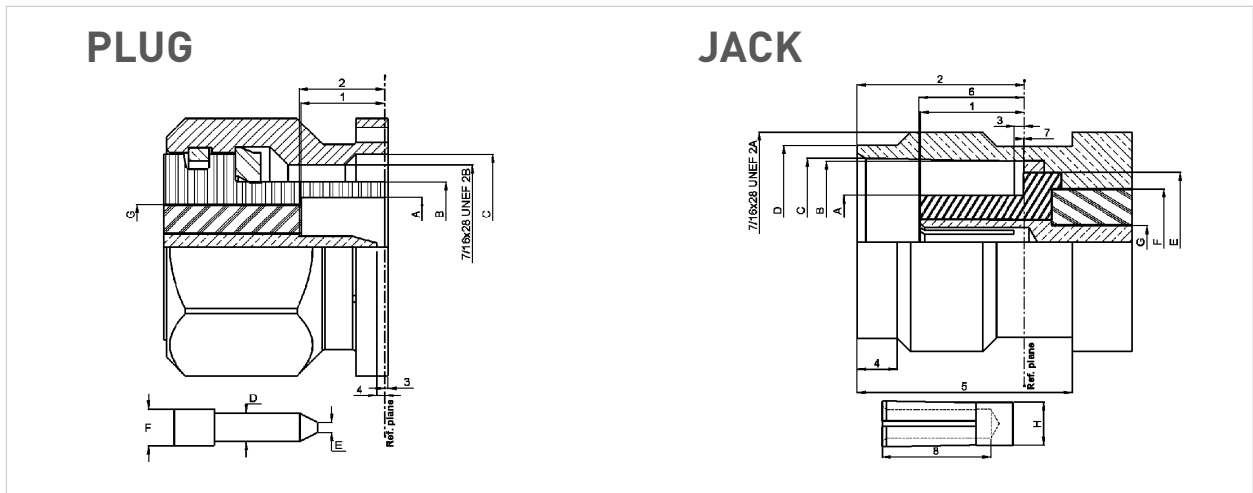

Letter	mm		inch	
	min.	max.	min.	max.
A	6.18	6.22	0.243	0.245
B	8.03	8.09	0.316	0.319
C	11.40	11.60	0.449	0.457
D	1.34	1.36	0.053	0.054
E	0.35	0.65	0.014	0.026
F	1.62	1.66	0.064	0.065
G	5.28	5.32	0.208	0.210
1	5.28	5.38	0.208	0.212
2	5.35	5.50	0.211	0.217
3	-0.30	0.55	-0.012	0.022
4	0.35	0.90	0.014	0.065

Letter	mm		inch	
	min.	max.	min.	max.
A	4.68	4.72	0.184	0.186
B	8.10	8.15	0.319	0.321
C	8.32	8.46	0.328	0.333
D	9.61	9.68	0.379	0.381
E	6.93	6.98	0.273	0.275
F	5.28	5.32	0.208	0.210
G	1.62	1.66	0.064	0.065
H	2.14	2.18	0.084	0.086
1	4.98	5.23	0.196	0.206
2	8.36	8.46	0.329	0.333
3	0.48	1.02	0.019	0.040
4	1.80	2.20	0.071	0.087
5	10.60	11.00	0.417	0.432
6	5.18	5.28	0.204	0.208
7	-0.10	0.05	0.004	0.002
8	5.20	5.70	0.204	0.224

## Characteristics

Test / Characteristics	MIL-C-39012 A	Values / Remarks
------------------------	---------------	------------------

## ELECTRICAL CHARACTERISTICS

Impedance	-	50Ω
Frequency range	-	DC - 18 GHz
V.S.W.R.	3-14	Semi-rigid cable: 1.17 max Flexible cable: 1.35 at 12.4 GHz   In series adapter: 1.35 max
Insertion loss	3-27	0.18 dB max at 9 GHz
RF leakage	3-26	-60 dB min from 2 to 3 GHz
Insulation resistance	3-11	5000 MΩ min
Contact resistance	3-16	Initial 1.5 0.2
• Center contact (mΩ)	-	After proof 2 -
• Outer contact (mΩ)	-	
Working voltage		At sea level: 500 V rms   at 70000 ft (21000 m): 125 V rms
Dielectric withstanding voltage	3-17	At sea level: 1500 V rms   at 70000 ft (21000 m): 375 V rms
RF withstanding voltage	3-23	At sea level: 1000 V rms [5 MHz sine wave]

## MECHANICAL CHARACTERISTICS

Durability	3-15	500 matings
Mating / unmating	-	axial force: not applicable torque: 1.96 inch pounds (22.6 N.cm)
Recommended mating torque	-	22.98 inch pounds (265 N.cm)
Proof torque	-	29.40 inch pounds (339 N.cm)
Coupling mechanism retention force	3-25	100 Lbf (44.5 daN)
Cabling retention force	3-24	51 Lbf (227 N min) [cable dia. .189 (4.8) to .228 (5.8)] 76.4 Lbf (340 N min) [cable dia. .250 (6.35) and above]
Center contact retention	-	Axial: 6.06 Lbf (27 N)

## ENVIRONMENTAL CHARACTERISTICS

Temperature range	-	-65°C / + 165°C
• Standard models	-	-65°C / +100°C
• Hermetic sealed models	-	-65°C / +105°C
• Models for semi-rigid cables	-	
Combined climate tests		
Thermal shock	3-20	MIL-STD-202, method 107, condition B
High temperature endurance	-	MIL-STD-202, method 108
Corrosion (salt spray)	3-13	MIL-STD-202, method 101, condition B
Vibrations	3-18	MIL-STD-202, method 204, condition B
Shocks	3-19	MIL-STD-202, method 213, condition G
Moisture resistance	3-21	MIL-STD-202, method 106
Low pressure	3-22	Not applicable
Hermetic seal	-	Applied vacuum 10 <sup>-6</sup> mm of Hg (Torr) Leakage rate < 10 <sup>-6</sup> atm/cm <sup>2</sup> /s
Leakage	-	Pressure 3.5 bars; duration 2 mn; temperature 15°C to 25°C

## MATERIALS

Body	-	Stainless steel
Center socket contact	-	Brass Bronze
• Male		
• Female		
Ferrules	-	Brass
Insulators	-	PTFE teflon
Gaskets	-	Silicone elastomer

## PLATING

Body	-	Passivated
Center contacts	-	Gold plated

## Plugs and Jacks

### STRAIGHT PLUGS CRIMP TYPE FOR FLEXIBLE CABLE

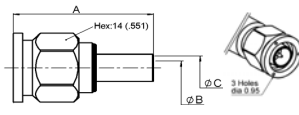

Fig. 1

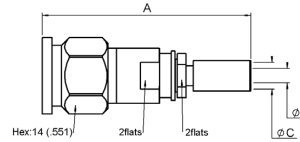
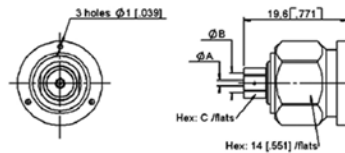

Fig. 2

Cable group	Cable group dia.	Part number	Fig.	Dimensions mm (inch)			Note
				A	B	C	
RG142 / RG223 / RG400	5/50/D	R143 082 700	1	30 [1.181]	3.2 [1.26]	5.5 [2.18]	Incl. heatshrink tube
		R143 097 700		43.5 [1.713]	3 [1.18]	5.5 [2.18]	
-	3.85/50/S	R143 088 101	2	47 [1.85]	3 [1.18]	4.2 [1.65]	
-	4.13/50	R143 093 700		43.5 [1.71]	2.7 [1.06]	4.5 [1.77]	
-	8.07/50/S	R143 092 790		49.7 [1.957]	6.3 [2.48]	8.4 [3.31]	
RG214 / RG225	11/50/D	R143 089 700	1	35 [1.38]	7.5 [2.95]	11 [4.33]	-

### STRAIGHT PLUGS SOLDER TYPE FOR SEMI-RIGID CABLE



Cable group	Cable group dia.	Part number	Dimensions mm (inch)		
			A	B	C
RG402	.141"	R143 051 700	1 [.039]	3.65 [1.44]	5 [1.97]
RG401	.250"	R143 054 700	1.7 [1.067]	6.45 [2.54]	8 [3.15]

### RIGHT ANGLE PLUGS CRIMP TYPE FOR FLEXIBLE CABLE

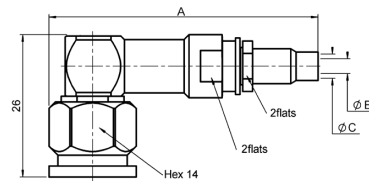

Cable group	Cable group dia.	Part number	Dimensions mm (inch)			Note
			A	B	C	
-	3.85/50/S	R143 188 101	54.2 [2.13]	3 [1.18]	4.2 [1.65]	Incl. heatshrink tube
-	4.13/50	R143 191 700	50 [1.97]	2.7 [1.06]	4.5 [1.77]	

Standard packaging = unit

All dimensions are given in mm (inch)

Plugs and Jacks

STRAIGHT JACK SOLDER TYPE FOR SEMI-RIGID CABLE

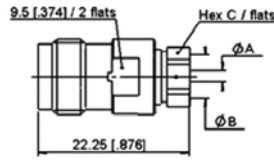

Cable group	Cable group dia.	Part number	Dimensions mm (inch)		
			A	B	C
RG402	.141"	R143 227 700	1 (.039)	3.65 (.143)	5 (.197)

STRAIGHT SQUARE FLANGE JACK CRIMP TYPE FOR FLEXIBLE CABLE

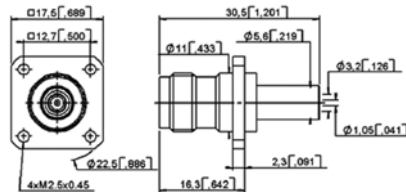

Fig. 1

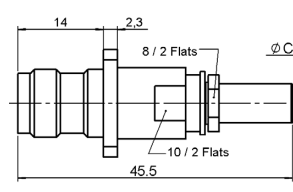
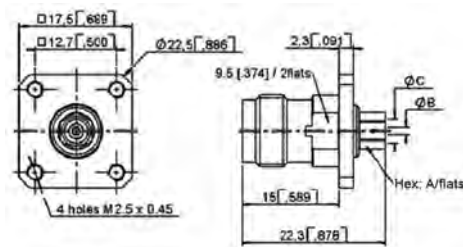

Fig. 2

Cable group	Cable group dia.	Part number	Fig.	C	Panel drilling	Note
-	4.13/50	R143 295 700	2	4.4 (.173)	P01	Ind. heatshrink tube
RG142 / RG223 / RG400	5/50/D	R143 292 700	1	5.6 (.219)		
		R143 297 700	2			

STRAIGHT SQUARE FLANGE JACKS SOLDER TYPE FOR SEMI-RIGID CABLE



Cable group	Cable group dia.	Part number	Dimensions mm (inch)			Panel drilling
			A	B	C	
RG405	.085"	R143 272 700	4 (.157)	0.6 (.024)	2.25 (.089)	P12
RG402	.141"	R143 273 700	5 (.197)	1 (.039)	3.65 (.144)	
RG401	.250"	R143 274 700	8 (.315)	-	6.45 (.254)	



Jacks and Receptacles

STRAIGHT BULKHEAD JACK PANEL SEALED

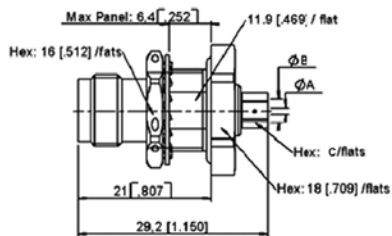

Fig. 1

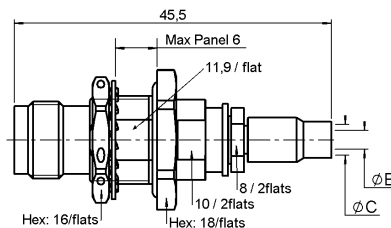
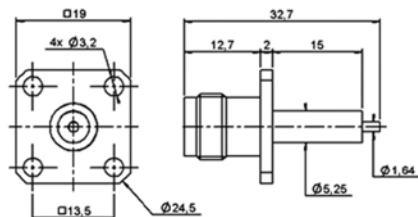

Fig. 2

Cable group	Cable group dia.	Part number	Fig.	Dimensions mm (inch)		Panel drilling	Type
				B	C		
RG402	.141"	R143 321 700	1	3.65 (.144)	5 (.197)	P09	Solder
RG401	.250"	R143 322 700		6.45	8		Crimp
	4.13/50	R143 340 700	2	2.7	4.5		

SQUARE FLANGE STRAIGHT FEMALE RECEPTACLE (extended dielectric)



Part number	Captive center contact	Panel drilling
R143 412 700	Yes	P13

Adapters and Caps

IN SERIES ADAPTERS

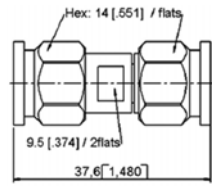

Fig. 1

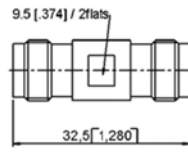

Fig. 2

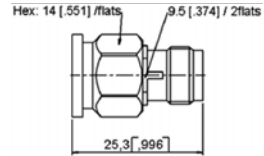

Fig. 3

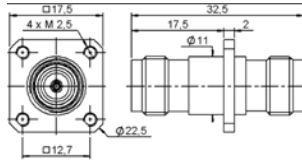

Fig. 4

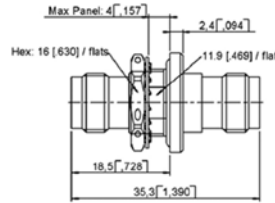
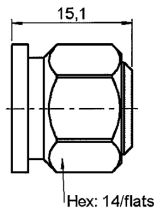

Fig. 5

Part number	Fig.	Captive center contact	Panel drilling	Note
R143 703 700	1	Yes	-	Male - Male
R143 704 700	2		-	Female - Female
R143 705 700	3		-	Male - Female
R143 710 700	4		P16	Square flange female - Female
R143 730 700	5		P09	Bulkhead panel sealed female - Female

CAPS



Part number	Note
R143 850 700	Male short circuit

**Introduction**

SMA 2.9 series is compatible with K<sup>®</sup> series, 2.92 mm, SMA and SMA 3.5 series, and has a shortened male center contact, ensuring a non destructive mating. Radiall offers four product variations for SMA 2.9 to meet all your needs with two different designs. The standard design is using our "ULTEM" insulator technology and is qualified up to 40 GHz. The high frequency design is using our "KAPTON" insulator technology and is qualified up to 46 GHz. All versions feature the same electrical high performance and are available in a variety of configurations.

**SMA 2.9 FOR GENERAL USE, "ULTEM" TECHNOLOGY, DC-40 GHz**

This robust design is suitable for most applications. The ULTEM insulator provides a high ingress protection level against chemicals, fluids or dust and is well suited for high frequency aerospace and military equipment.

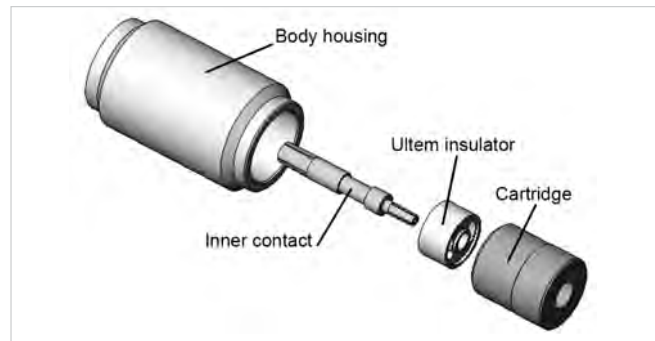

3D view of SMA 2.9 "ULTEM" design

**SMA 2.9 FOR TEST LABORATORY USE, "KAPTON" TECHNOLOGY, DC-46 GHz**

The KAPTON insulator design is excellent for high frequency measurements in test laboratories. KAPTON is also very stable with temperature. Radiall SMA 2.9 adapters using KAPTON are specified DC-46 GHz and operate within a large temperature range - 65°C/+200°C.

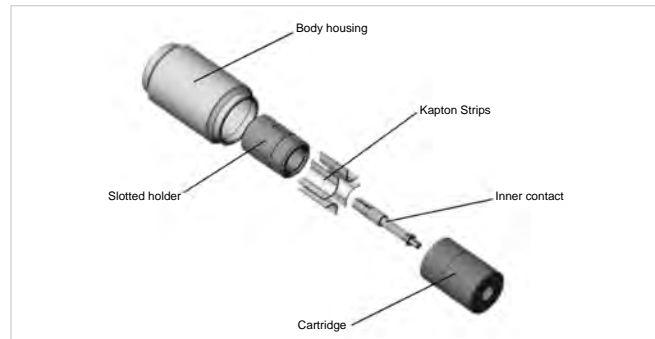

3D view of SMA 2.9 "KAPTON" design

**SMA 2.9 FOR SPACE APPLICATIONS**

Radiall is a certified manufacturer of connectors for space applications according to ESA specifications. A range of space qualified SMA 2.9 connectors using the ULTEM insulator technology is available. Please consult us.

**SMA 2.9 FOR HARSH ENVIRONMENTS**

Radiall also offers a range of cable assemblies equipped with specific connectors for applications in harsh environment. The connectors are made of high grade stainless steel 316L ultra resistant to corrosion and wear. Please consult us.

Interface

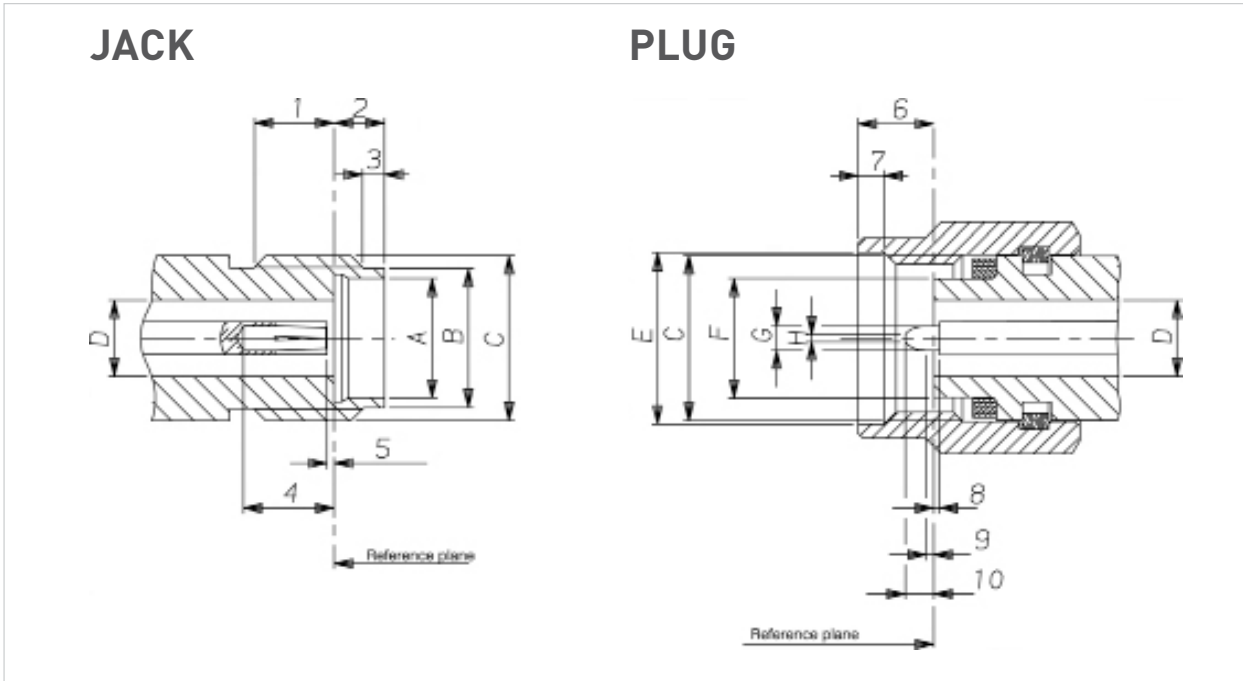

Letter or Figure	mm		inch	
	min.	max.	min.	max.
1	2.87	3.27	.113	.129
2	1.88	1.98	.074	.078
3	0.65	0.95	.026	.037
4	2.40	2.68	.094	.105
5		0.08	-	.003
A	4.60	4.63	.181	.182
B	5.30	5.35	.209	.211
C	1/4 - 36 UNS 2A			
D	2.90	2.94	.114	.116

Letter or Figure	mm		inch	
	min.	max.	min.	max.
6	2.63	3.25	.103	.128
7	0.90	1.10	.035	.043
8		0.08	-	.003
9	0.49	0.78	.019	.031
10	1.22	1.40	.048	.055
C	1/4 - 36 UNS 2B			
D	2.90	2.94	.114	.116
E	6.60	6.70	.260	.264
F	4.55	4.58	.179	.180
G	0.92	0.94	.036	.037
H	0.20	0.34	.008	.013

## Characteristics

Test / Characteristics	Values / Remarks	
	ULTEM technology	KAPTON technology

### ELECTRICAL CHARACTERISTICS

Impedance	50Ω	
Frequency range	DC - 40 GHz	DC - 46 GHz
V.S.W.R.	< 1.05 + 0.005 F (GHz)	
Insertion loss	0.03 √ F (GHz)	
RF leakage	- 90 dB max	
Insulation resistance	≥ 5000 MΩ	
Contact resistance	≤ 2 mΩ	
• Outer conductor	straight ≤ 3 mΩ	
• Inner conductor	hermetic ≤ 7 mΩ	
Voltage rating	350 V(RMS)	
Dielectric withstanding voltage	750 V(RMS)	

### MECHANICAL CHARACTERISTICS

Mechanical endurance	500 matings	
Force to engage and disengage	≤ 23 N cm [2 in/lbs]	
Mating torque	80 to 115 N cm [7 to 10 in/lbs]	
Coupling nut retention force	≤ 272 N [61 lbf]	
Cable retention force		
• .085"	135 N (30 lbf)	
• .141"	270 N (60 lbf)	
Contact captivation	28N (6.3 lbf)	

### ENVIRONMENTAL CHARACTERISTICS

Temperature range	-65°C / + 165°C	-65°C / +200°C
Thermal shock	MIL STD 202, method 107, condition B	
High temperature test	MIL STD 202, method 108	
Corrosion (salt spray)	MIL STD 202, method 101, condition B, 5 %	
Vibration	MIL STD 202, method 204, condition D, 20g	
Shock	MIL STD 202, method 213, condition I, 100g	
Moisture resistance	MIL STD 202, method 106	

### MATERIALS AND PLATING

	Material	Plating
Bodies	Stainless steel	Passivated
Center contacts	Beryllium copper	Gold plated
Gaskets	Silicone rubber	-
Insulators	Ultem (Ultem technology) Kapton (Kapton technology)	-

Packaging: unit

All dimensions are given in mm (inch).

## Plugs

### STRAIGHT PLUGS, SOLDER TYPE FOR MICROPOROUS SEMI-RIGID CABLES

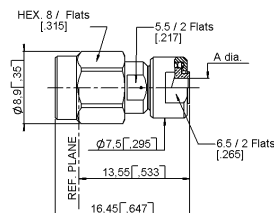

Cable group	Cable group dia.	Part number	Insulator	Dimension A (mm)	Captive center contact	Frequency range
RG405	.085" microporous	R127 800 001	ULTEM	2.25	Yes	DC - 40 GHz
RG402	.141" microporous	R127 800 101		3.66		
RG405	.085" microporous	R127 052 001	KAPTON	2.2		DC - 46 GHz
-	.116" microporous	R127 055 001		3.0		

Jacks and Receptacles

STRAIGHT JACK SOLDER TYPE FOR MICROPOROUS SEMI-RIGID CABLES

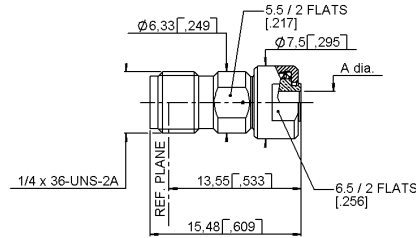

Cable group	Cable group dia.	Part number	Insulator	Dimension A (mm)	Captive center contact	Frequency range
RG405	.085" microporous	R127 820 001	ULTEM	2.25	Yes	DC - 40 GHz

UNIVERSAL SCREW-ON FEMALE RECEPTACLES

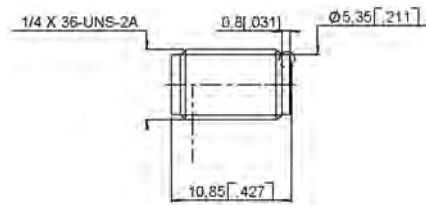

Part number	Insulator	Frequency range	Used with glass bead	For pin diameter
R127 841 001	ULTEM	DC - 40 GHz	R280 760 040	0.3 [.012]
R127 601 001	KAPTON	DC - 46 GHz	R280 760 000 included	
R127 601 421				

FLANGE FEMALE RECEPTACLES

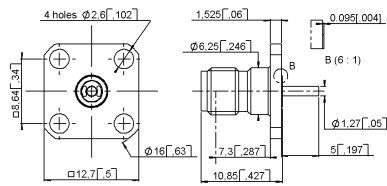

Fig. 1

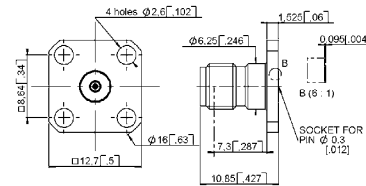

Fig. 2

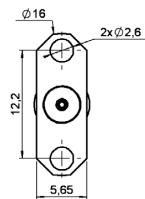

Fig. 3

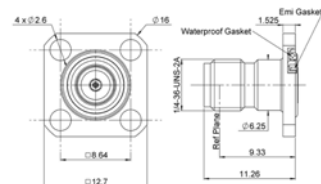
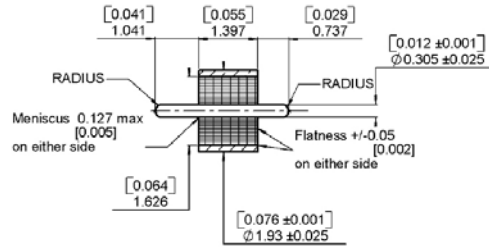
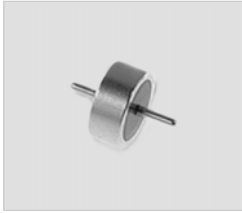

Fig. 4

Part number	Fig.	Insulator	Captive center contact	Panel drilling	Used with glass bead	Note
R127 840 021	1	ULTEM	Yes	P02	N/A	With cylindrical center contact
R127 842 001	2			P01	R280 760 040	Accept pin dia 0.3 [.012]
R127 631 001	3	KAPTON		-		
R127 632 001						
R127 842 101	4	PEEK		P01	-	Accept pin dia 0.3 [.012] Panel leakage IP67

## Glass Bead and In Series Adapters

### GLASS BEAD



Part number	Packaging
R280 760 040	100

### IN SERIES ADAPTERS

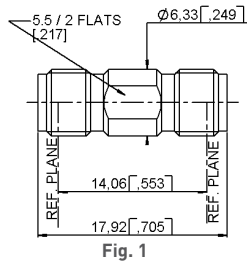

Fig. 1

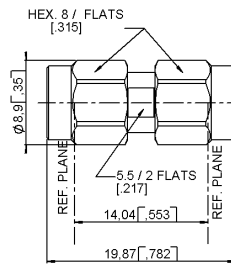

Fig. 2

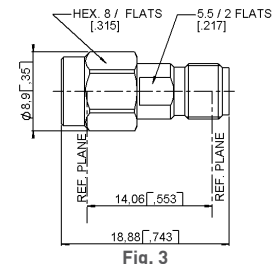

Fig. 3

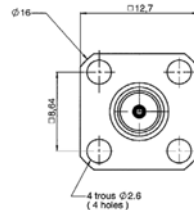

Fig. 4

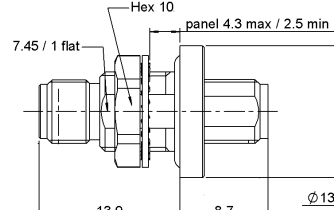

Fig. 5

Part number	Fig.	Insulator	Note	Frequency range
R127 703 001	2	KAPTON	Male - Male	DC - 46 GHz
R127 704 001	3		Female - Male	
R127 705 001	1		Female - Female	
R127 712 001	4		Female - Female - 4 hole flange	
R127 732 100	5		Female - fFemale - Bulkhead panel sealed	
R127 753 000	5		Female - Female - Bulkhead hermetic	
R127 870 001	1	ULTEM	Female - Female	DC - 40 GHz
R127 872 001	3		Female - Male	
R127 871 001	2		Male - Male	

Between Series Adapters

BETWEEN SERIES ADAPTERS

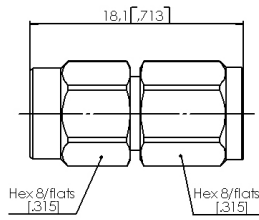

Fig. 1

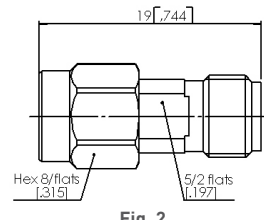

Fig. 2

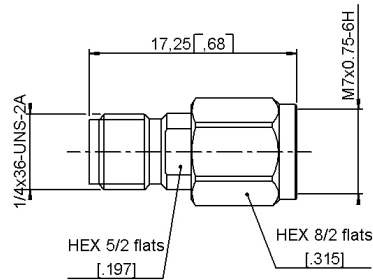

Fig. 3

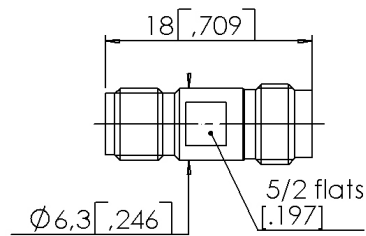

Fig. 4

Part number	Fig.	Insulator	Note	Frequency range
R191 970 061	1	KAPTON	SMA 2.9 male - SMA 2.4 male	DC - 46 GHz
R191 970 071	2		SMA 2.9 male - SMA 2.4 female	
R191 970 081	3		SMA 2.9 female - SMA 2.4 male	
R191 970 091	4		SMA 2.9 female - SMA 2.4 female	

**Remark:**

These adapters are still using the previous technology (4 kapton strips) allowing to reach 46 GHz within a temperature range of - 65 °C/+ 200 °C.

Panel Drilling

P01

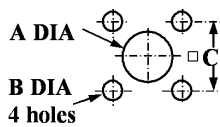

letter	mm		inch	
	maxi	mini	maxi	mini
A	1.63	1.60	.064	.063
B	2.70	2.60	.106	.102
C	8.69	8.59	.342	.338

P02

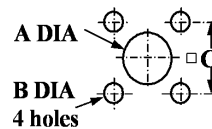

letter	mm		inch	
	maxi	mini	maxi	mini
A	2.95	2.91	.116	.115
B	2.7	2.6	.106	.102
C	8.69	8.59	.342	.338



**Introduction**

2.4 mm connectors are 50 ohm precision connectors designed for use to 50 GHz. The design eliminates the fragility of the SMA and 2.92 mm connectors by increasing the outer wall thickness and strengthening the female fingers. The outer conductor measures 2.4 mm and the robust wall of the connector body is designed to engage before the center conductor, assuring a rugged, repeatable mating interface. The male connectors are provided with a 8 mm [5/16 in.] hex coupling nut so they can be properly torqued.

2.4 mm connectors are mechanically compatible with 1.85 mm connectors. They cannot mate with SMA, 3.5-mm and 2.92-mm without the use of precision adapters.

Radiall offers 2.4 mm connectors for semi-rigid and low loss flexible cables, receptacles, and precision adapters.

Connectors for low loss flexible cables and TestPro cables are not detailed in this section. They are available in our cable assembly offer.

**2.4 mm DESIGN FEATURES**

- Excellent performance up to 50 GHz
- Low VSWR and insertion loss
- Rugged construction for reliability
- Mechanically compatible with 1.85 mm connector series

**Interface**

**JACK**

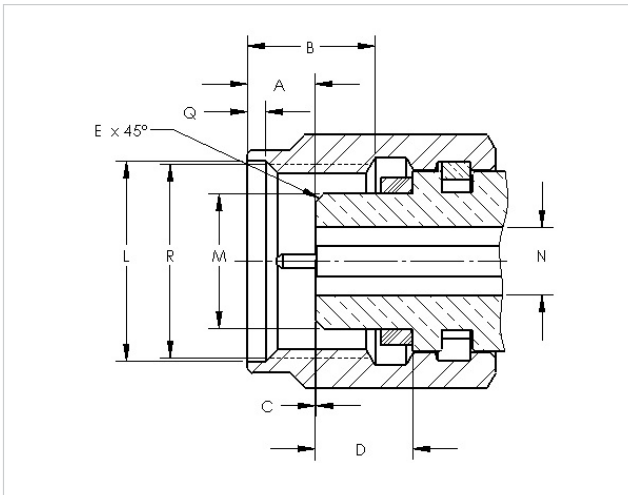

Letter	mm		inch
	min.	max.	min.
A	1.8500	2.4500	0.0728
B	4.3400	4.6600	0.1709
C	0.0000	0.0760	0.0000
D	3.3800	3.4800	0.1331
L	7.0100	7.1100	0.2760
M	4.7250	4.7500	0.1860
N	2.3875	2.4125	0.0940
Q	0.5100	0.7700	0.0201
R	M7x0.75-6H		

**PLUG**

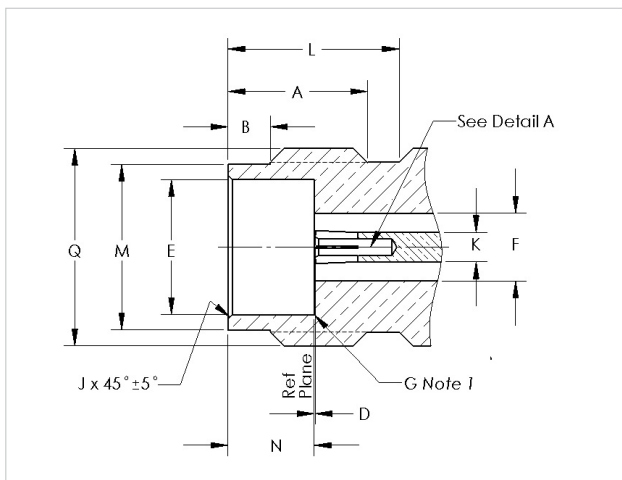

Letter	mm		inch
	min.	max.	min.
A	4.8000	5.0600	0.1890
B	1.3700	1.6300	0.0539
D	0.0000	0.0760	0.0000
E	4.7700	4.7950	0.1878
F	2.3875	2.4125	0.0940
K	1.0290	1.0540	0.0405
L	6.0000	-	0.2362
M	5.7900	5.8900	0.2280
N	3.0000	3.1000	0.1181
Q	M7x0.75-6g		

## Characteristics

Test / Characteristics	Values / Remarks
------------------------	------------------

**ELECTRICAL CHARACTERISTICS**

Impedance	50Ω
Frequency range	DC - 50 GHz
V.S.W.R.	< 1.05 + 0.003 F (GHz)
Insertion loss	0.04 √ F (GHz)
RF leakage	- 100 dB max
Insulation resistance	<= 1400Veff
- contact resistance	≥ 5000 mΩ
Contact resistance	
• Outer conductor	≤ 0.8 mΩ
• inner conductor	≤ 4 mΩ
Voltage rating	250 V(RMS)
Dielectric withstanding voltage	500 V(RMS)

**MECHANICAL CHARACTERISTICS**

Mechanical endurance	500 matings
Force to engage and disengage	≤ 23 N cm
Mating torque	90 N cm
Coupling nut retention force	≤ 272 N
Cable retention force	
• Outer conductor	130 N
• inner conductor	
Contact captivation	27N

**ENVIRONMENTAL CHARACTERISTICS**

Temperature range	-65°C / + 165°C
Thermal shock	MIL STD 202, method 107, condition B, -65°C / + 165°C
High temperature test	MIL STD 202, method 108, condition D, 1000 H at 150°C
Corrosion (salt spray)	MIL STD 202, method 101, condition B, 48 H / 35°C / 5 %
Vibration	MIL STD 202, method 204, condition H, 30g RMS
Shock	MIL STD 202, method 213, condition I, 100g
Moisture resistance	MIL STD 202, method 106, 80% / 100% 25°C / 65°C 10 cycles

**MATERIALS AND PLATING**

	Material	Plating
Bodies	Beryllium copper	Cu2.5 Au0.8
Outer contact (body insert)	Brass	Cu2.5 Au0.8
Center contacts	Beryllium copper	Ni2 Au1.3
Coupling nut	Stainless steel	Passivated
Gaskets	Silicone rubber	-
Insulators	PEEK	-

Plugs, Jacks and Receptacles

**STRAIGHT PLUGS, SOLDER TYPE FOR SEMI-RIGID CABLES**

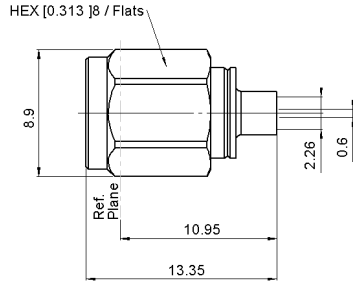

Cable group	Cable group dia.	Part number	Captive center contact
RG405	.085"	R327 052 000	Yes
RG405	.085" microporous	R327 052 202	

**STRAIGHT JACKS, SOLDER TYPE FOR SEMI-RIGID CABLES**

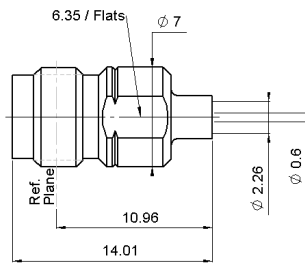

Fig. 1

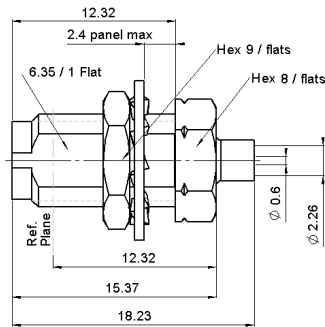
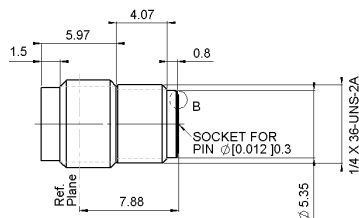

Fig. 2

Cable group	Cable group dia.	Fig.	Part number	Captive center contact
RG405	.085"	1	R327 222 000	Yes
	.085" microporous		R327 222 200	
	.085"	2	R327 316 000	
	.085" microporous		R327 316 010	

**UNIVERSAL SCREW-ON FEMALE RECEPTACLES**



Part number	Using with glass bead	For pin diameter
R327 556 000	R280 760 040	0.3 [0.12]

Receptacles and Glass Bead

FLANGE RECEPTACLES

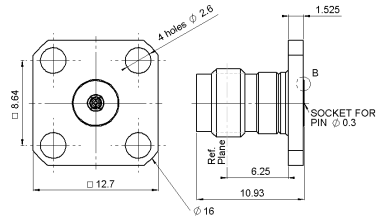

Fig. 1

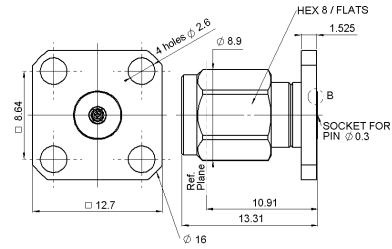

Fig. 2

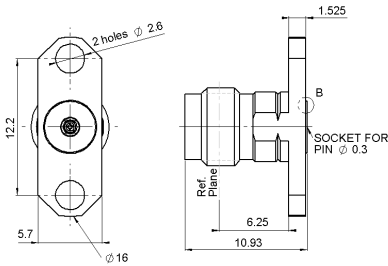
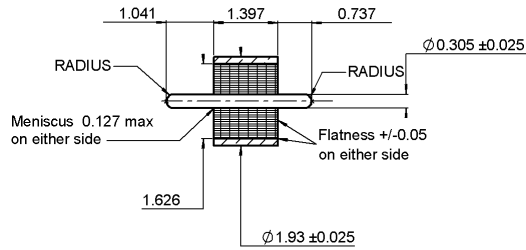

Fig. 3

Part number	Fig.	Captive center contact	Panel drilling	Use with glass bead	For pin diameter
R327 430 000	1	Yes	P01	R280 760 040	0.3 (0.12)
R327 411 000	2		P02		
R327 465 000	3				

GLASS BEAD



Part number	Packaging
R280 760 040	100

In Series Adapters and Panel Drilling

IN SERIES ADAPTERS

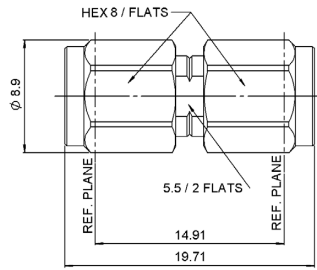

Fig. 1

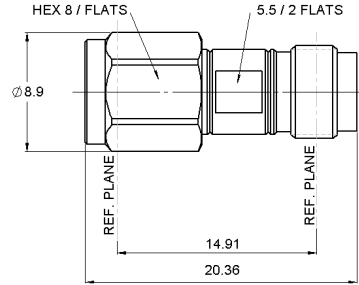

Fig. 2

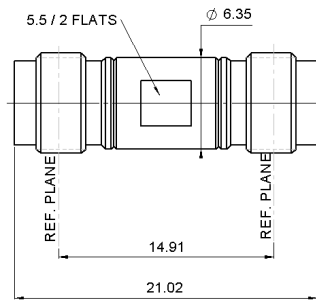

Fig. 3

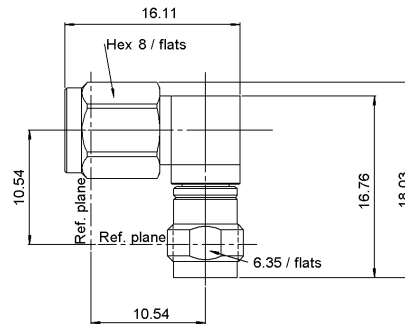
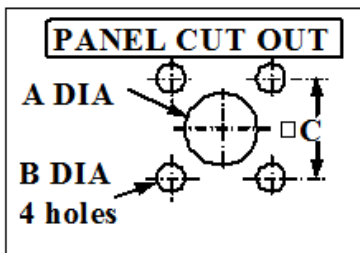

Fig. 4

Part number	Fig.	Note
R327 703 000	1	Male / Male
R327 704 000	2	Male / Female
R327 705 000	3	Female / Female
R327 771 000	4	Male / Female right angle

Panel Drilling

P01



P02

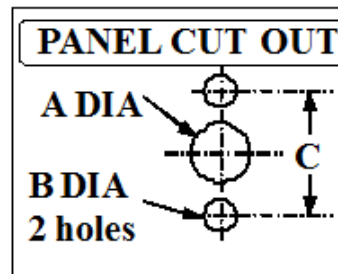

Letter	mm		inch	
	min.	max.	min.	max.
A	1.63	1.60	0.064	0.063
B	2.70	2.60	0.106	0.102
C	8.69	8.59	0.342	0.338



## N/TNC/C

R161/R162/R143/R144/R166

**Contents****TYPE N**

Introduction .....	11-4 to 11-5
Panel drilling .....	11-23

**N 50Ω and COMPOSITE N**

Interface .....	11-6
Characteristics .....	11-8 to 11-9
Plugs .....	11-11 to 11-13
Jacks .....	11-13 to 11-16
Receptacles .....	11-16 to 11-19
Composite N receptacle .....	11-18
Adapters .....	11-19
Caps .....	11-20
Accessories .....	11-20

**N 75Ω**

Interface .....	11-7
Characteristics .....	11-10
Plugs .....	11-21
Jacks .....	11-21
Receptacles .....	11-22
Adapters .....	11-22

**TNC**

Introduction .....	11-24
Interface .....	11-25
Characteristics .....	11-26
Panel drilling .....	11-34

**TNC 50Ω**

Plugs .....	11-27 to 11-28
Jacks .....	11-28 to 11-30
Receptacles .....	11-30 to 11-31
Caps .....	11-31
Adapters .....	11-32

**TNC 75Ω**

Plugs .....	11-33
Jacks .....	11-33

**C CONNECTORS**

Introduction .....	11-35
Interface .....	11-35
Characteristics .....	11-36
Plugs, jacks and receptacles .....	11-37 to 11-38
In series adapters .....	11-38
Panel drilling .....	11-38

## Introduction



50Ω

DC - 11 GHz (standard N)  
DC - 18 GHz (N 18 GHz)**GENERAL**

- Standard coaxial connectors
- Screw-on coupling
- High durability and proven strength
- High power rating
- Excellent RF performance

**APPLICATIONS**

- Wireless communications
- Civil and military radio-telecommunication equipment
- Countermeasure
- Navy equipment
- Industrial applications

**APPLICABLE STANDARDS**

- MIL-C-39012 / MIL STD 348-304
- CEI 169-16
- CECC 22210
- NF-C-93566
- DS 8811

**COMPOSITE AND SWITCHING CONNECTORS****FULL CRIMP MODELS**

This reliable attachment system can be easily installed in a field environment, with easy-to-use tooling (including models for 2 and 2.6 mm dia cables). All our full crimp connectors are single piece body.

**18 GHz PRECISION CONNECTORS**

These connectors are suitable for medium to high power applications and precision microwave test equipment. They have long life duration and enhanced electrical performance in severe environmental conditions. N18 series mate with all 50 ohms N connectors.

**LOW INTERMODULATION CONNECTORS**

Radiall extensive knowledge in this field led to the development of N series connectors that are specially designed for base stations of applications where the elimination of intermodulation products is of the utmost importance. Features:

- Optimized for 900 - 1800 MHz bands (and able to work up to 11 GHz like the standard models)
- IMP<sub>3</sub> performance = -110 dBm (-153 dBc)
- New models for corrugated and low loss flexible cables
- High performance non magnetic materials and platings (silver and BBR)
- New 6 flats coupling nut (18 mm), allowing high coupling torque (170 Ncm) thanks to torque wrench
- Non slotted outer contact





## Introduction

Radiall offers a wide range with a standard plating finish: **BBR (Bright Bronze Radiall)** a high performance non-magnetic alloy.

### VERY LOW INTERMODULATION CABLE ASSEMBLIES

For severe intermodulation conditions, we propose a range of low intermodulation cable assemblies  $IMP3 \leq 125$  dBm.

For further details, reference:

- Intermodulation application guide **(D1 032 DE)**
- BBR plating application guide **(D1 030 DE)**

**IMPORTANT:** The 50 $\Omega$  and the 75 $\Omega$  connectors are NOT INTERMATEABLE and results in the destruction of the interface.

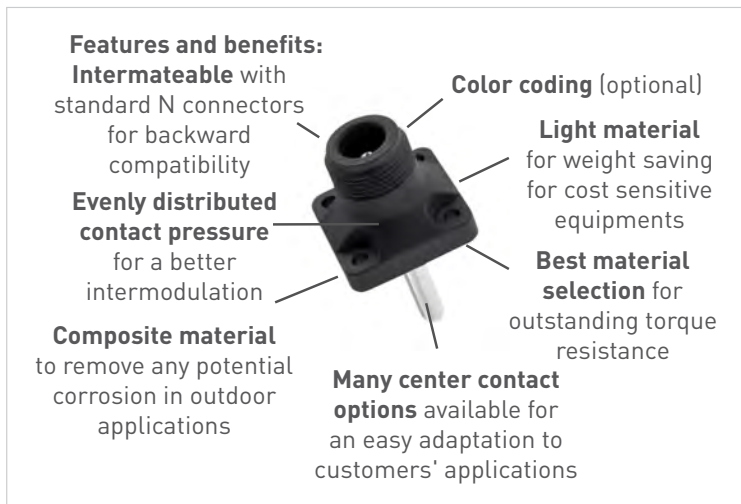

### COMPOSITE RECEPTACLES

Radiall introduces its new composite N receptacles. Composite N connectors offer outstanding electrical performance and are the best compromise in terms of weight, cost and mechanical characteristics to replace existing brass technology.

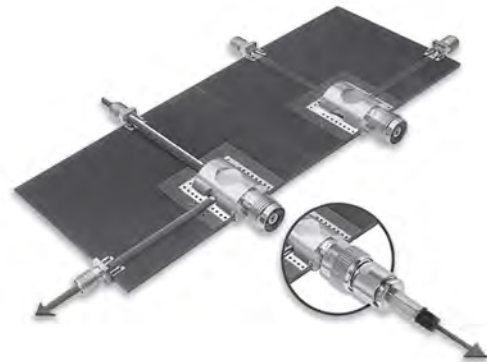

### POWER SWITCHING CONNECTORS

This "two-in-one" solution replaces the existing standard RF switches by integrating the switch function into a receptacle connector. This solution provides a unique means of switching between two RF signal paths. As user friendly as a standard connector, the switch is mechanically activated by mating and unmating the connector.

#### Advantages

- Reliable
- Increases the density
- Excellent electrical and mechanical performance
- Reduction of the cost of ownership
- Betty RF adaptation
- Good isolation
- Available in right or left versions

#### Applications

- Telecom applications
- RF power amplifiers

### PLATING

Radiall offers a wide range with a standard plating finish: **BBR (Bright Bronze Radiall)** a high performance non-magnetic alloy.

Interface N 50 Ω

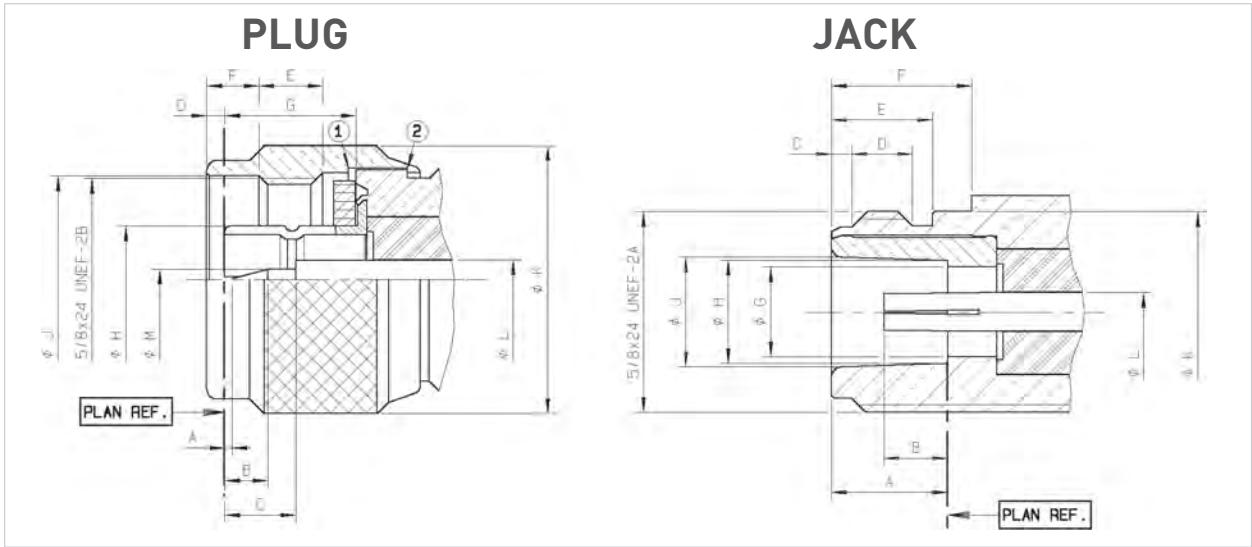

LETTER	mm		inch	
	min.	max.	min.	max.
A	0.13	1.03	.005	.13
B	2.80	3.56	.110	.140
C	5.33	5.83	.210	.229
D	1	2	.016	.066
E	4.54	5.39	.179	.212
F	4.05	4.20	.159	.165
G	10.23	10.43	.403	.411
H DIA	8.27	8.37	.326	.329
J DIA	16.1	16.2	.634	.638
K DIA	20.9	21	.823	.827
L DIA	3.01	3.05	.118	.120
M DIA	1.63	1.67	.064	.066

LETTER	mm		inch	
	min.	max.	min.	max.
A	9.05	9.19	.356	.362
B	4.75	5.25	.187	.207
C	1.20	1.95	.047	.077
D	4.4	5.1	.173	.201
E	6.8	9	.268	.354
F	10.9	11.2	.429	.441
G DIA	6.98	7.02	.275	.276
H DIA	8.03	8.13	.316	.320
J DIA	8.53	8.73	.336	.344
K DIA	15.65	15.85	.616	.624
L DIA	3.01	3.05	.118	.120

Interface N75 Ω

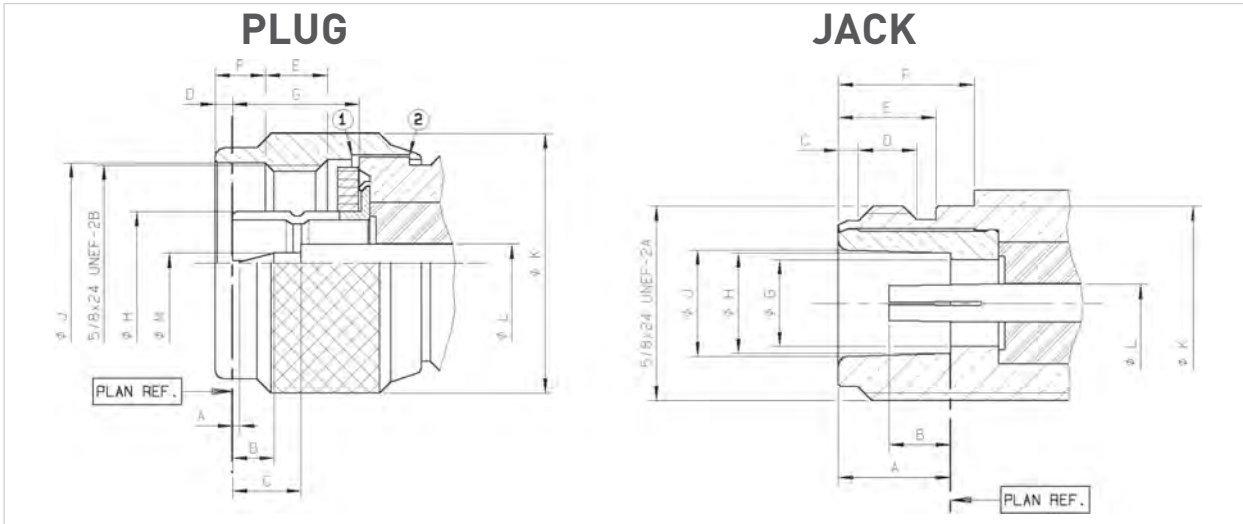

LETTER	mm		inch	
	min.	max.	min.	max.
A	0.13	1.03	.005	.13
B	2.80	3.56	.110	.140
C	5.33	5.83	.210	.230
D	1	2	.016	.066
E	4.54	5.39	.179	.212
F	4.05	4.20	.159	.165
G	10.23	10.43	.403	.411
H DIA	8.27	8.37	.326	.329
J DIA	16.1	16.2	.634	.638
K DIA	20.9	21	.823	.827
L DIA	1.96	2	.077	.079
M DIA	0.87	0.91	.034	.036

LETTER	mm		inch	
	min.	max.	min.	max.
A	9.05	9.19	.356	.362
B	4.75	5.25	.187	.207
C	1.20	1.95	.047	.077
D	4.4	5.1	.173	.201
E	6.8	9	.268	.354
F	10.9	11.2	.429	.441
G DIA	6.98	7.02	.275	.276
H DIA	8.03	8.13	.316	.320
J DIA	8.53	8.73	.336	.344
K DIA	15.65	15.85	.616	.624
L DIA	1.96	2	.077	.079

\*statistics dimensions: .0539 .0055 (.0594 max)/(1.37 0.14)(1.51 max)

- 1) Coupling nut against on datum 1
- 2) Coupling nut against on datum 2

**IMPORTANT: the 50Ω and the 75Ω connectors are NOT INTERMATEABLE, results in the interface destruction.**

## Characteristics

Test / Characteristics	Standard reference	Values / Remarks
------------------------	--------------------	------------------

## ELECTRICAL CHARACTERISTICS

Impedance	-	50Ω
Frequency range	-	DC - 11 GHz
Typical V.S.W.R.	-	1 GHz
Frequency	-	2.5 GHz
• Straight models cable group: .085"	-	5 GHz
.141"	-	11 GHz
.250"	-	
5/S+5/D	-	
10/S+11/D	-	
• Right angle models: 5/S+D	-	
10/S+11/D	-	
Intermodulation product (IMP <sub>3</sub> )	-	- 90 dBm typ. [- 133 dBc typ. / 20W]
• Standard connectors	-	- 110 dBm typ. [- 153 dBc typ. / 20W]
• Intermodulation connectors	-	- 125 dBm typ. [- 165 dBc typ. / 20W]
• Home made intermodulation cable assemblies	-	
Insertion loss	MIL	< 0.15 dB max at 10 GHz ~ < 0.05 √F (GHz) < 0.15 dB max at 10 GHz ~ < 0.1 √F (GHz)
• Straight connector		
• Right-angle connector		
RF Leakage	MIL	-90 dB min from 2 to 3 GHz (interface)
Insulation resistance	MIL	5000 MΩ min
Contact resistance	MIL	Initial 1 mΩ 0.2 mΩ
• Center contact		After tests 1.5 mΩ -
• Outer contact		
Working voltage in VRMS	CECC	Cable 5/50: 850 (250)
• At sea level		Cable .085"/.141": 350 (250)
(at 70, 000 feet)		Cable 10+11/50: 1400 (400)
		Cable LMR 400/600: 1400 (400)
		Cable .250": 1400 (400)
Dielectric withstanding voltage in VRMS	CECC	Cable 5/50: 1500 (350)
• At sea level		Cable .085"/.141": 1000 (350)
(at 70, 000 feet)		Cable 10/50: 2500 (600)
		Cable LMR 400/600: 2500 (600)
		Cable .250": 2500 (600)
RF testing voltage	CECC	1500 VRMS (5 MHz sine wave)
Sea level		

## MECHANICAL CHARACTERISTICS

Durability	CECC	500 matings
Engagement and separation torque	CECC	6.6 Ncm max (.58 Inch-pounds)
Recommended coupling nut torque	-	40 to 60 Ncm (manual) 130 Ncm (11.45 inch pounds) (with pliers R 282 202 000) 170 Ncm (14.96 inch pounds) (with torque wrench R 282 303 020)
Proof torque	CECC	170 Ncm (14.96 inch pounds)
Coupling nut retention force	CECC	450 N (101.25 Lbs)
Cable retention force	CECC	Cable 5/50/S 150N (33.75 Lbs) Cable 5/50/D 200N (48 Lbs) Cable 10/50 300N (67.5 Lbs) Cable 11/50 400N (90 Lbs) Cable .141" 270N (60.75 Lbs)
Center contact retention force	MIL	27 N (6.08 Lbs) cables < ∅ 8 mm 68 N (15.30 Lbs) cables > ∅ 8 mm
Axial		

Standard packaging = 50 pieces

## Characteristics

Test / Characteristics	Standard reference	Values / Remarks
------------------------	--------------------	------------------

### ENVIRONMENTAL CHARACTERISTICS

Temperature range • Standard models • Semi-rigid cables	CECC	- 55°C + 155°C - 55°C + 105°C
Thermo cycling test	CECC	- 55°C/+ 155°C/21 j
Thermal shock	CECC	- 40°C/+ 155°C or - 40°C/+ 85°C - 5 cycles
High temperature test	CECC	125°C/1000 H
Corrosion salt spray	CECC	48 H
Vibration	CECC	Sinus 10g/10 - 500 Hz
Shock	CECC	1/2 Sinus 50g/11 ms
Moisture resistance • Clamp type • Crimp type	IEC 529	IP 67 IP 65 (with heatshrink sleeve)
Hermetic test	CECC	10 <sup>-5</sup> bar. cm <sup>3</sup> /s
Leakage	CECC	Differential pressure 100 to 110 KPa: 1 bar cm <sup>3</sup> / H

### MATERIALS

Body / nut / center male contact / outer contact	Brass
Center female contact	Treated beryllium copper
Ferrule	Brass
Insulator	PTFE
Gasket	Silicon elastomer

### PLATING

	Standard	Intermodulation models + COAXI-KIT
Body • Crimp + clamp type • Solder type	BBR Gold	Silver + BBR Silver
Coupling nut/Design	BBR / Cross knurled	BBR / Hex.
Center contacts	Gold	Silver
Outer contacts/Design	BBR / Slotted	Silver + BBR / Non slotted

### PACKAGING

Packaging	50 pieces bulk Unit packaging
-----------	----------------------------------

Some connectors may feature different performances depending on the application they have been designed for, or according to the applicable cable.

## Characteristics

Test / Characteristics	Standard reference	Values / Remarks
------------------------	--------------------	------------------

## ELECTRICAL CHARACTERISTICS

Impedance	-	75Ω
Frequency range	-	DC - 1.5 GHz
Typical V.S.W.R.	-	
• Cable 6/75	-	1.06
• Cable 10+11/75	-	1.10
Insertion loss		
• Straight connector	MIL	< 0.15 dB
• Right-angle connector		
RF Leakage	MIL	- 90 dB min at 1 GHz
Insulation resistance	MIL	5000 MΩ min
Contact resistance		
• Center contact	MIL	Initial 1 mΩ
• Outer contact		After tests 1.5 mΩ
Working voltage in VRMS at sea level (at 70 000 feet)	CECC	Cable 10+11/75: 1400 (400) Cable 6/75: 850 (250)
Dielectric withstanding voltage in VRMS At sea level (At 70 000 feet)	CECC	Cable 10+11/75: 2500 (600) Cable 6/75: 1500 (350)
RF testing voltage Sea level	CECC	1500 VRMS (5 MHz sine wave)

## MECHANICAL CHARACTERISTICS

Durability	CECC	500 matings
Engagement and separation torque	CECC	6.6 Ncm max (.58 Inch-pounds)
Recommended coupling nut torque	CECC	40 to 60 Ncm (manual) 130 Ncm (11.45 inch pounds) (with pliers R282 202 000)
Proof torque	CECC	170 Ncm (14.96 inch pounds)
Coupling nut retention force	CECC	450 N (101.25 Lbs)
Cable retention force		
• Cable 6/75	CECC	200 N
• Cable 10+11/75		300 N
Center contact retention force Axial	MIL	27 N (6.08 Lbs)

## ENVIRONMENTAL CHARACTERISTICS

Temperature range	CECC	- 55°C + 155°C
Thermo cycling test	CECC	- 55°C / + 155°C / 21 j
Thermal shock	CECC	- 40°C / + 155°C or - 40°C / + 85°C - 5 cycles
Hight temperature test	CECC	125°C / 1000 H
Corrosion salt spray	CECC	48 H
Vibration	CECC	Sinus 10 g / 10 - 500 Hz
Shock	CECC	1/2 Sinus 50g / 11 ms
Moisture resistance		
• Clamp type	IEC 529	IP 67
• Crimp type		IP 65 (with heatshrink sleeve)
Hermetic test	CECC	10-5 bar. cm <sup>3</sup> /s
Leakage	CECC	Differential pressure 100 to 110 KPa: 1 bar cm <sup>3</sup> / H

## MATERIALS

Body (nut)/center male contact/outer contact)	Brass
Center female contact	Treated beryllium copper
Ferrule	Brass
Insulator	PTFE
Gasket	Silicon elastomer

## PLATING

Body	BBR
Coupling nut/design	BBR / Cross knurled
Center contact	Gold
Outer contact/design	BBR / Slotted

Standard packaging = 50 pieces

## Plugs

## STRAIGHT PLUGS, FULL CLAMP AND CRIMP TYPE, FOR FLEXIBLE CABLES (single piece body)

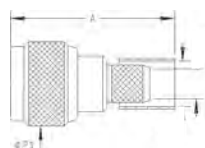

Fig. 1

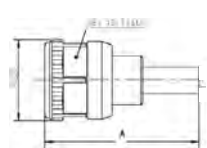

Fig. 2

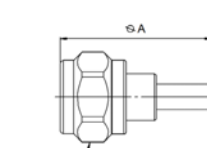

Fig. 3

Cable group	Cable group dia.	Part number	Fig.	Dimensions (mm)		Captive center contact	Note
				A			
RG174 / RG316 / RD316 / AEP-100FR	2.6/50/S+D & LMR® 100	R161 072 000	1	39.7	Yes	-	
RG58 / R141	5/50/S	R161 082 000 R161 083 000		38.5		-	
RG142 / RG223 / RG400	5/50/D	R161 083 137	2	38.5	-	For intermodulation application tool	
RG213	10/50/S	R161 075 000 R161A 075 000	1	40.2	No	-	
-	10.3/50/S	R161 075 060 R161 088 000		40.2	Yes	LMR 400 cable	
RG214	11/50/D	R161 088 137	2	40.2	-	For intermodulation application tool	
AEP-195FR	LMR® 195	R161 082 120	3	38.5	Yes	Crimp type	
AEP-200FR	LMR® 200	R161 082 200	1	38.5			
AEP-240FR	LMR® 240	R161 075 030	3	38.5			
AEP-400FR	LMR® 400	R161 088 180		40.1			
RD316	2.6/50D	4000-7071-019	1	40.41	No	Crimp type for flexible cable	

## STRAIGHT PLUGS, CLAMP TYPE, FOR FLEXIBLE CABLES

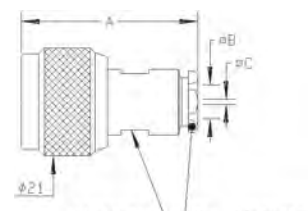

Fig. 1

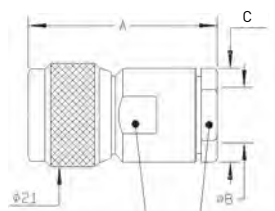

Fig. 2

Cable group	Cable group dia.	Part number	Fig.	Dimensions (mm)			Captive center contact
				A	B dia.	C dia.	
RG174 / RG316 / RD316	2.6/50/S+D	R161 004 000	1	33.9	3.1	1.7	Yes
RG58 / RG141 / RG142 / RG223 / RG400	5/50/S+D	R161 006 000 R161 010 000		34.4	5.6	-	No
RG59 / RG62 / RG71	6/75+93	R161 012 000		34.9	5.6	-	Yes
RG213 / RG393 / RG11 / RG12 / RG144 / RG214 / RG216	10+11/50+75	R161 018 000 R161 020 000 R161 022 000		34.4	6.6	-	-
RG217	14/50/D	R161 018 000	2	44	11.2	17.5	-
		R161 020 000		38.1	11.2	17.5	No
		R161 022 000		38.9	11.2	19	Yes
		R161 027 000		40.9	14.4	22.2	-

Plugs

STRAIGHT PLUGS, FOR SEMI-RIGID CABLES

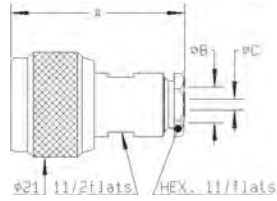

Fig. 1

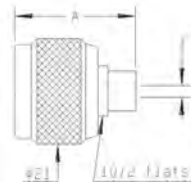

Fig. 2

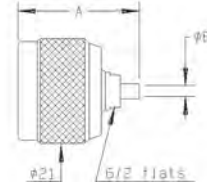

Fig. 3

Cable group	Cable group dia.	Part number	Fig.	Dimensions (mm)			Captive center contact	Note
				A	B dia.	C dia.		
RG405	.085"	R161 050 300	3	24.4	2.25	-	-	Solder type
RG402	.141"	R161 051 000			3.65	-		
RG401	.250"	R161 052 000	1	35	5.6	3.65	No	Clamp type
		R161 053 000			35.4	6.6		
		R161 054 000	2	24.4	6.45	-		Solder type

RIGHT ANGLE PLUGS, CRIMP TYPE, FOR FLEXIBLE CABLES



Fig. 1

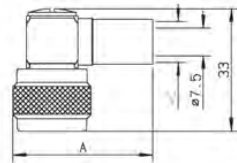

Fig. 2

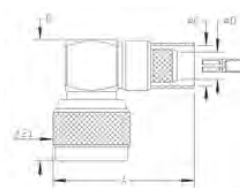

Fig. 3

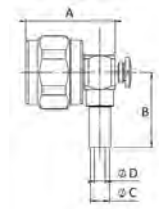

Fig. 4

Cable group	Cable group dia.	Part number	Fig.	Dimensions (mm)				Captive center contact	Note				
				A	B	C dia.	D dia.						
RG174 / RG316	2.6/50/S	R161 181 000	1	29.5	26.3	-	-	-	-				
RG58 / RG141	5/50/S	R161 182 000		34.5	28	5.41	-		-				
RG142 / RG223 / RG400	5/50/D	R161 183 000	3	42.4	33.2	11.05	7.46	Yes	-				
		R161A 183 000							28	5.8	3.1	-	
		R161 185 000	3	42.4	33.2	11.05	7.46		ECO version				
		R161 186 000	2	37.6	-	11.4	-		Full crimp				
RG214	11/50/D	R161 187 000	3	42.4	33.2	11.4	7.46		-				
AEP-200FR	LMR® 200	R161 182 080	4	26.3	22	5.55	3.25	Yes	Crimp type				
AEP-240FR	LMR® 240	R161 183 310								24	6.6	4.05	
AEP-400FR	LMR® 400	R161 184 080								27	33	11.05	7.46
AEP-600FR	LMR® 600	R161 188 200								31.7	39.1	15.88	11.96

RIGHT ANGLE PLUGS, CLAMP TYPE, FOR FLEXIBLE CABLES

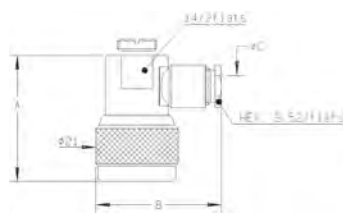

Fig. 1

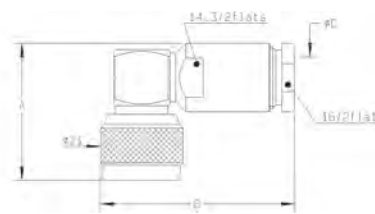

Fig. 2

Cable group	Cable group dia.	Part number	Fig.	Dimensions (mm)			Captive center contact
				A	B	C dia.	
RG223 / RG142 / RG223 / RG400	5/50/S+D	R161 157 000	1	32	32	5.6	Yes
RG213 / RG393 / RG214	10+11/50/S+D	R161 168 000	2	34.85	49.4	11.2	



Plugs and Jacks

**RIGHT ANGLE PLUG, SOLDER TYPE, FOR SEMI-RIGID CABLES**

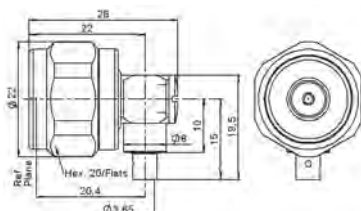

Cable group	Cable group dia.	Part number	Captive center contact
RG402	.141"	R161 152 107	Yes

**STRAIGHT JACKS, FULL CRIMP TYPE, FOR FLEXIBLE CABLES (single piece body)**

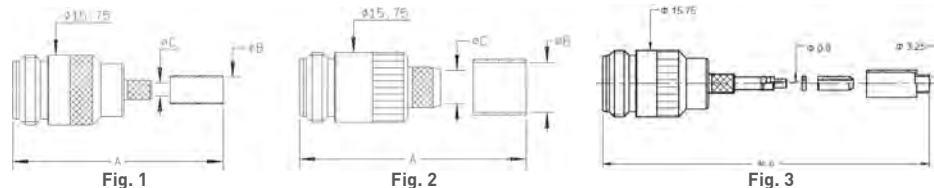

Cable group	Cable group dia.	Part number	Fig.	Dimensions (mm)			Captive center contact
				A	B dia.	C dia.	
RG58 / RG216 / RD316	2.6/50/S+D	R161 236 000	3	-	-	-	Yes
RG58 / RG141	5/50/S	R161 237 000	1	39.3	5.41	3.11	
RG142 / RG223 / RG400	5/50/D	R161 238 000			5.8		
RG223	10/50/S	R161 241 000	2	40.6	11.05	7.46	
RG214	11/50/D	R161 243 000			11.4		

**STRAIGHT JACKS, CLAMP TYPE, FOR FLEXIBLE CABLES**

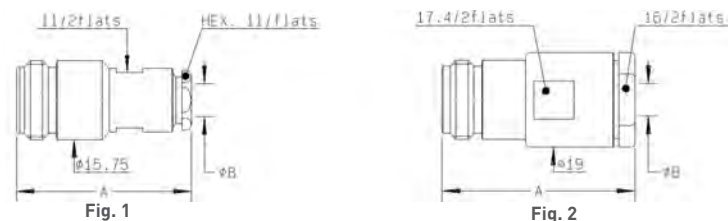

Cable group	Cable group dia.	Part number	Fig.	Dimensions (mm)		Captive center contact
				A	B dia.	
RG58 / RG142 / RG223 / RG400	5/50/S+D	R161 206 000	1	35.3	5.6	Yes
RG213 / RG393 / RG214	10+11/50/S+D	R161 220 000	2	39.3	11.2	

**STRAIGHT JACKS**

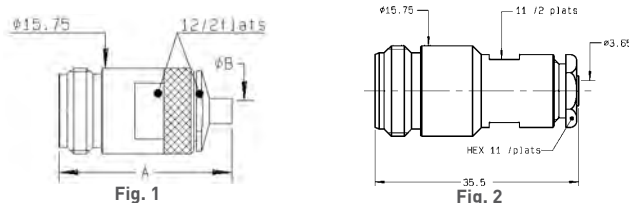

Cable group	Cable group dia.	Part number	Fig.	Dimensions (mm)		Captive center contact	Note
				A	B dia.		
RG402	.141"	R161 226 020	1	32	3.65	No	Solder type
		R161 227 000	2	-	-	-	Clamp type

Jacks

**SQUARE FLANGE, STRAIGHT JACKS, FULL CRIMP TYPE, FOR FLEXIBLE CABLES (single piece body)**

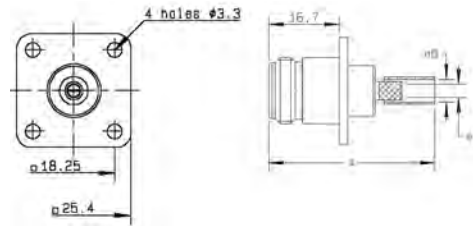

Cable group	Cable group dia.	Part number	Dimensions (mm)			Captive center contact	Panel drilling
			A	B dia.	C dia.		
RG178	2/50/S+D	R161 281 000	40.3	2.35	1	-	P01
RG174 / RG316 / RD176	2.6/50/S+D	R161 281 300	40.3	3.25	1.63	-	
RG58 / RG141	5/50/S	R161 282 000	39.3	5.41	-	-	
RG142 / RG223 / RG400 / RG213	5/50/D	R161 283 000	39.3	5.8	3.11	Yes	
RG213	10/50/S	R161 286 000	40.6	11.05	7.46	-	

**SQUARE FLANGE, STRAIGHT JACKS**

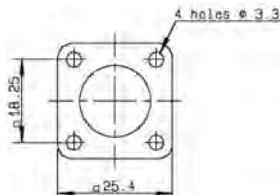

Fig. 1 and 2

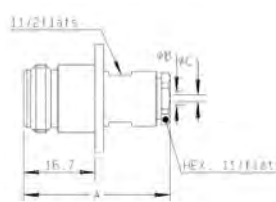

Fig. 1

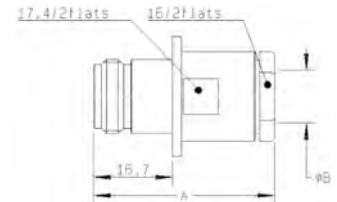

Fig. 2

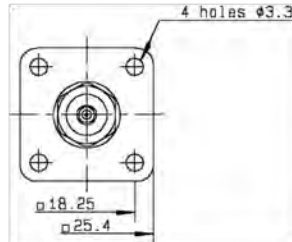
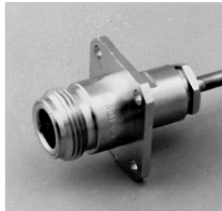

Fig. 3 and 4

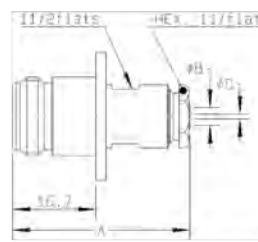

Fig. 3

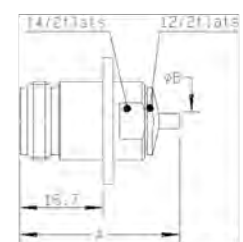

Fig. 4

Cable group	Cable group dia.	Part number	Fig.	Dimensions (mm)			Captive center contact	Panel drilling	Note
				A	B dia.	C dia.			
RG174 / RG316 / RD316	2.6/50/S + D	R161 252 000	1	34.3	3.1	1.7	Yes	P01	Clamp type
RG58 / RG141 / RG142 / RG223 / RG400	5/50/S + D	R161 256 000		35.4	5.6	-			
RG213 / RG393 / RG214	10 + 11/50/S + D	R161 270 000		39.3	11.2	-			
RG402	.141"	R161 277 000	3	35.5	5.6	3.65	No	P01	Solder type
RG401	.250"	R161 278 000	3	35.9	6.6	-			Clamp type

Bulkhead Jacks

**BULKHEAD STRAIGHT JACKS, FULL CRIMP TYPE, FOR FLEXIBLE CABLES (panel sealed) (single piece body)**

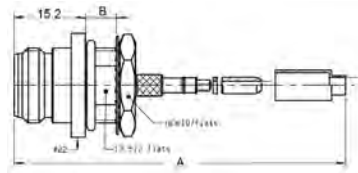

Fig. 1

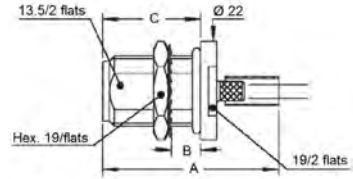

Fig. 2

Cable group	Cable group dia.	Part number	Fig.	Dimensions (mm)			Captive center contact	Panel drilling	Note
				A	B	C			
RG174 / RG316 / RD316	2.6/50/S+D	R161 311 200	1	40.4	6.5	-	Yes	P11	Front mount
		R161 311 300							Rear mount
RG58 / RG141	5/50/S	R161 329 000	2	39.8	6.5	22.2	Yes	P11	Rear mount
RG142 / RG223 / RG400	5/50/D	R161 329 200							
RG214	11/50D	R161 331 200							
AEP-200FR	LMR® 200	R161 329 130							
AEP-240FR	LMR® 240	R161 329 140							
AEP-400FR	LMR® 400	R161 331 060							
AEP-600FR	LMR® 600	R161 331 400							

**BULKHEAD STRAIGHT JACKS, CLAMP TYPE, FOR FLEXIBLE CABLES (panel sealed)**

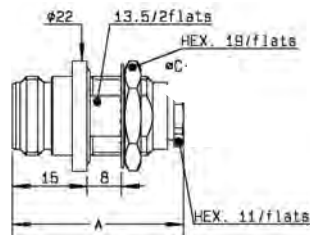

Fig. 1

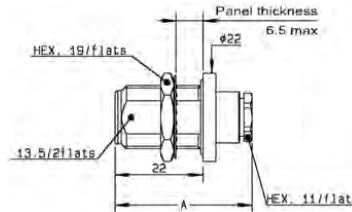

Fig. 2

Cable group	Cable group dia.	Part number	Fig.	Dimensions (mm)	Captive center contact	Panel drilling	Note
				A			
RG174 / RG316 / RD316	2.6/50/S+D	R161 321 000	1	34.3	Yes	P11	Front mount
		R161 322 000					Rear mount
RG58 / RG141 / RG142 / RG223 / RG400	5/50/S+D	R161 325 000	2	35.4	Yes	P11	Rear mount
RG213 / RG393 / RG214	10+11/50/S+D	R161 332 000					
RG174 / RG316	2.6/50S	4501-7051-003	1	26.7	No	-	Front mount
RG174 / RG316	2.6/50S	4502-7051-003					Hex. nut 16mm Body dia. 17.5mm

Bulkhead Jacks and Receptacles

**BULKHEAD STRAIGHT JACKS, FOR SEMI-RIGID CABLES (panel sealed)**

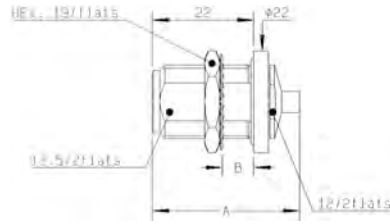

Fig. 1

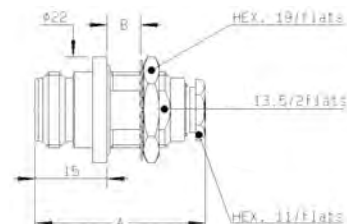

Fig. 2

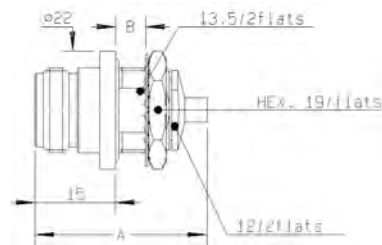

Fig. 3

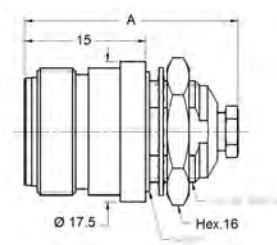
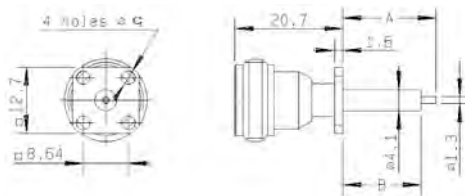

Fig. 4

Cable group	Cable group dia.	Part number	Fig.	Dimensions (mm)		Captive center contact	Panel drilling	Note
				A	B			
RG405	.085"	R161 335 200	1	32	6.5	No	P11	Solder type / Rear mount
RG402	.141"	R161 323 000	2	35.5	8			Solder type / Front mount
		R161 336 000	1	32	6.5			Solder type / Front mount
		R161 336 200	3					Solder type / Rear mount
RG401	.250"	R161 337 200	1	26.56	-			-
RG405	.085"	4502-7041-010	4			Solder clamp / Front mount		
RG402	.141"	4501-9543-009	1			33.52	-	

**LOW PROFILE SQUARE FLANGE, STRAIGHT FEMALE RECEPTACLE**



Part number	Dimensions (mm)			Captive center contact	Panel drilling	Note
	A	B	C dia			
R161 410 520	17.9	15	2.9	Yes	P08	Extended dielectric

Receptacles

FLANGE, STRAIGHT FEMALE RECEPTACLES

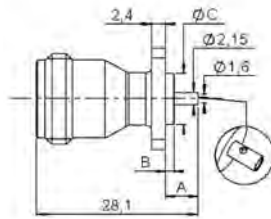

Fig. 1

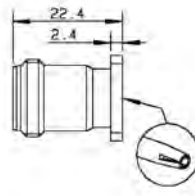

Fig. 2

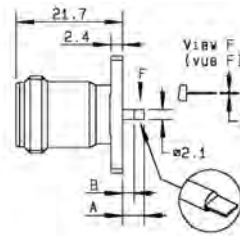

Fig. 3

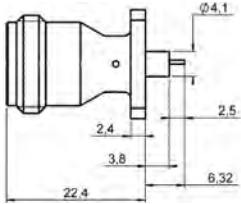

Fig. 4



Fig. A

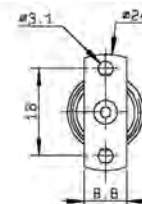

Fig. B

Part number	Fig.	Dimensions (mm)			Captive center contact	Panel drilling	Note
		A	B	C			
R161 410 000	1 + A	5.7	1.5	8.9	Yes	P03	-
R161A 410 000							ECO version
R161 410 130	4 + A	-	-	-		P13	Solder pot contact
R161 418 000	2 + A	-	-	-		P03	Universal / See contacts page 12-22
R161 461 000	3 + B	6.2	3.9	0.6		P09	2 hole flange / Flat tab contact

STRAIGHT MALE AND FEMALE RECEPTACLES

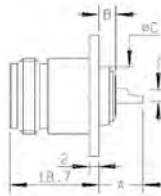

Fig. 1

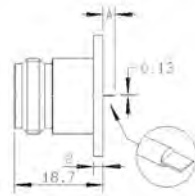

Fig. 2

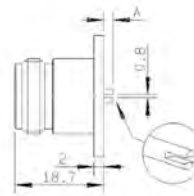

Fig. 3

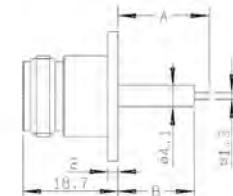

Fig. 4

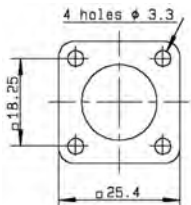

Fig. A

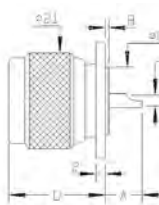

Fig. 5

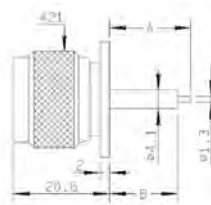

Fig. 6

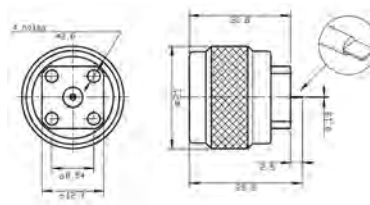
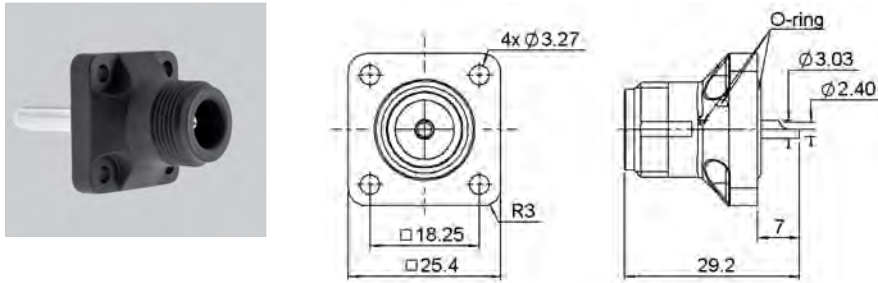

Fig. 7

Part number	Fig.	Dimensions (mm)				Captive center contact	Panel drilling	Note
		A	B	C dia	D			
R161 404 000	1 + A	9.3	0.8	14.6	-	Yes	P05	Solder pot
R161A 404 000					-			Solder pot / ECO version
R161 404 137					-			For intermodulation application / Center contact brass
R161 416 130	4 + A	17.9	15	-	P06		Extended dielectric	
R161 419 020	2 + A	2.5	-	-	P07		Flat tab contact	
R161 419 300	3 + A	2	-	-	P01	Slotted contact		
R161 441 000	5 + A	8.7	0.8	14.6	20.6	P02	Male / Solder pot	
R161 441 400	6 + A	17.9	15	-	-	P04	Male / Extended dielectric	
R161 438 200	7	-	-	-	-	P08	-	

## Receptacles

### COMPOSITE FEMALE RECEPTACLES



Part number	Captive center contact	Description	Color	Packaging
R161 404 C01	Yes	-	Black	50 pieces
R161 404 C02		Combination seal		
R161 404 C03		Panel seal		

Available upon request.  
Processed according to customer needs.

### RIGHT ANGLE FEMALE RECEPTACLES

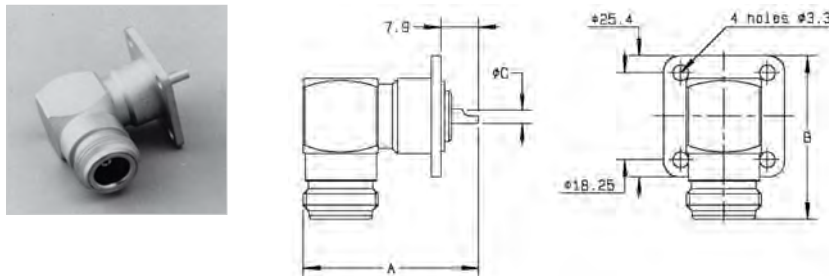

Part number	Dimensions (mm)			Captive center contact	Panel drilling	Note
	A	B	C dia			
R161 653 000	36.9	34.4	2.5	Yes	P02	Solder pot

### BULKHEAD STRAIGHT RECEPTACLES (fully sealed or panel hermetic)

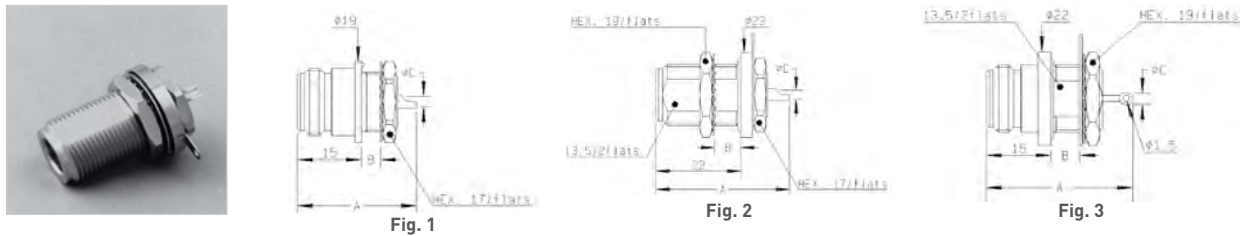

Part number	Fig.	Dimensions (mm)			Captive center contact	Panel drilling	Note
		A	B	C			
R161 570 000	1	28	4.5	2.4	Yes	P10	Front mount
R161 606 000	2	34.6	6.5	2.4		Rear mount / Fully sealed	
R161 625 000	3	34	6.5	2.5		P11	Front mount / Panel hermetic



Receptacles

N SMT SWITCH AND RECEPTACLE

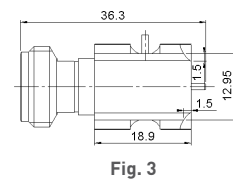
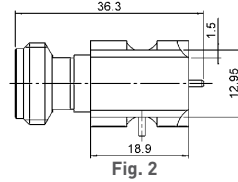
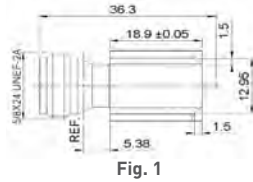

Part number	Fig.	Note
R161 427 223	1	Edge card female receptacle
R161 428 223	2	Edge card SMT left type switch
R161 428 233	3	Edge card SMT right type switch

Adapters

IN SERIES ADAPTERS

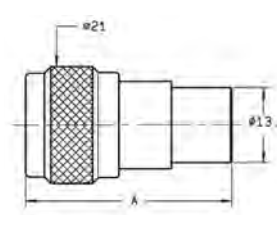
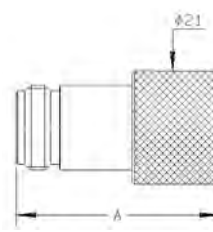
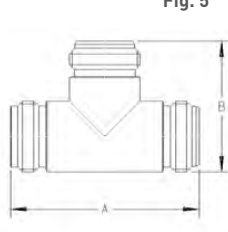
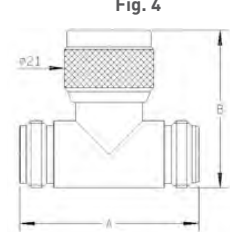
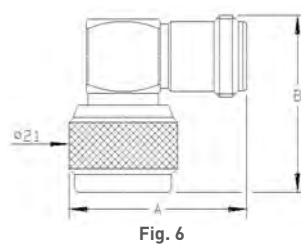
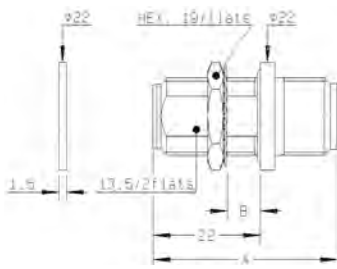
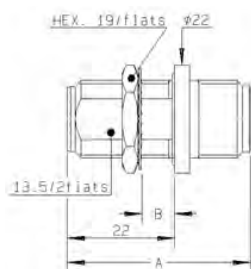
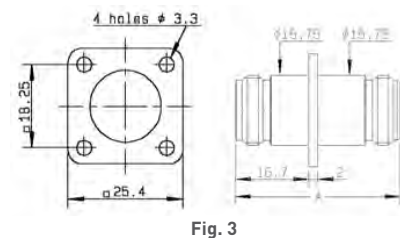
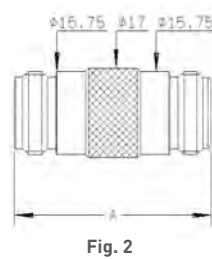
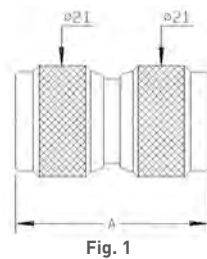

Part number	Fig.	Dimensions (mm)		Panel drilling	Note
		A	B		
R161 703 000	1	36.7	-	-	Male - Male
R161 705 000	2	-	-	-	Female - Female
R161 715 000	3	37.5	-	P01	Female - Female / Flange
R161 730 000	4	-	6.5	P11	Female - Female / Bulkhead panel sealed
R161 753 000	5	38	6.5	P11	Female - Female / Hermetic / Bulkhead
R161 771 000	6	34.4	34	-	Male - Female / Right angle
R161 780 000	7	42	36.9	-	Tee female - Female / Male
R161 782 000	8	-	29.1	-	Tee female - Female / Female
R161 791 500	9	37.37	-	-	Push-on male / Female screwing
R161 791 530	10	37.2	-	-	Push-on female / Male screwing

Caps and Accessories

PROTECTIVE CAPS

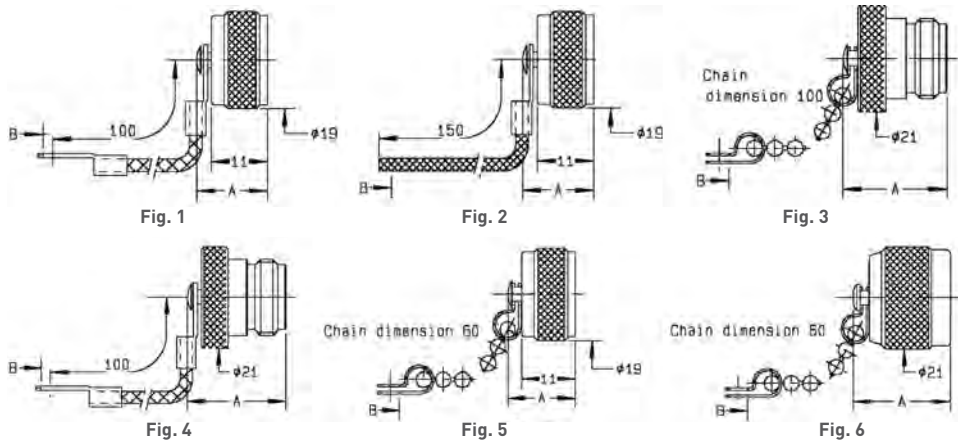

Part number	Fig.	Dimensions (mm)		Note
		A	B	
R161 804 000	1	13.9	3.8	Male with cord
R161 805 410	2	13.9	2	Male with cord
R161 841 000	3	20.4	3.9	Female with chain
R161 844 000	4	20.4	3.8	Female with cord
R161 853 000	5	13.9	3.9	Male with chain
R161 862 000	6	20.1		Male short circuit with chain

FIELD-REPLACEABLE CONTACTS (for universal receptacle)

These accessories have been specifically designed for the adjustment at the rear of hermetically sealed universal receptacles. The choice of their dimensions depends on the PCB or on the thickness of the MIC box. These contacts and insulators are also compatible with SMA UNIVERSAL RECEPTACLES.

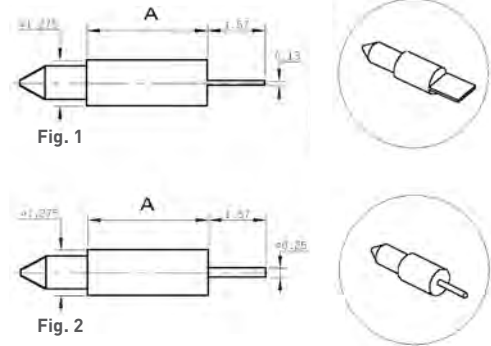
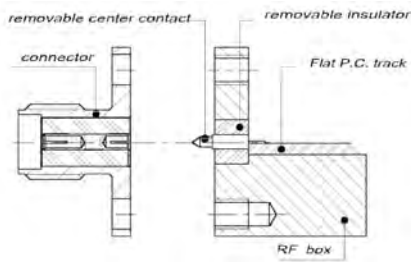

Part number	Fig.	A	Note	Associated insulator P/N
R280 461 000	1	3.37	Flat tab	R280 468 000
R280 463 000	2		Cylindrical tab	

FIELD-REPLACEABLE INSULATOR

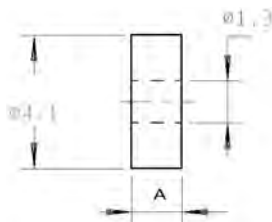

Part number	A	Packaging
R280 468 000	3.17	10



Plugs and Jacks

**STRAIGHT PLUGS, FOR FLEXIBLE CABLES**

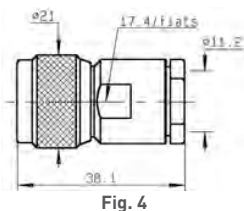
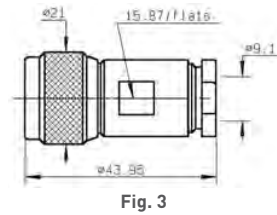
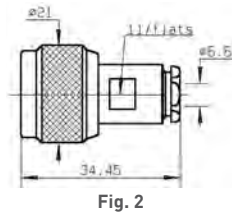
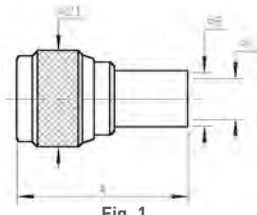

Cable group	Cable group dia.	Part number	Fig.	Dimensions (mm)			Captive center contact	Note
				A	B dia	C dia		
RG59 / RG62	6/75/S	R162 084 000	1	33.9	6.6	4	Yes	Crimp type
	6/75+93	R162 012 000	2	-	-	-	No	Clamp type
RG6	8/75/D	R162 013 000	3	-	-	-		
RG11 / RG12 / RG144 / RG216	10+11/75	R162 017 000	4	-	-	-		

**STRAIGHT JACKS, CLAMP TYPE, FOR FLEXIBLE CABLES**

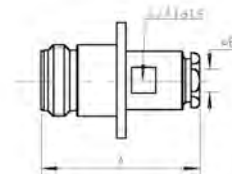
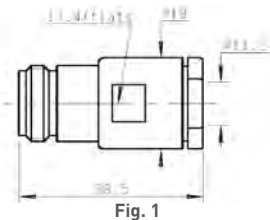

Cable group	Cable group dia.	Part number	Fig.	Dimensions (mm)			Captive center contact	Panel drilling	Note
				A	B	C			
RG11 / RG12 / RG144 / RG216	10+11/75	R162 217 000	1	-	-	-	No	-	-
RG59 / RG62	6/75+93/S	R162 262 000	2	34.9	6.6	11		P01	Square flange

**STRAIGHT BULKHEAD JACK, CLAMP TYPE, FOR FLEXIBLE CABLE (panel seal)**

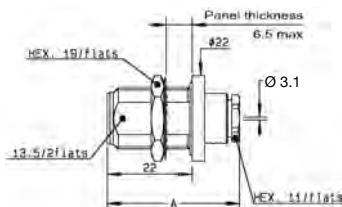

Cable group	Cable group dia.	Part number	Captive center contact	Panel drilling
RG179	2.6/75/S	R162 322 000	No	P11

Receptacles and Adapters

FEMALE RECEPTACLES

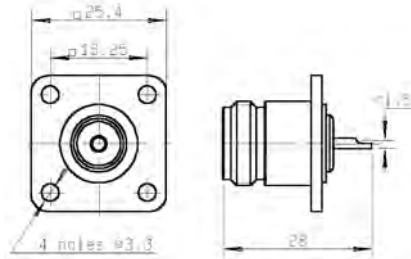

Fig. 1

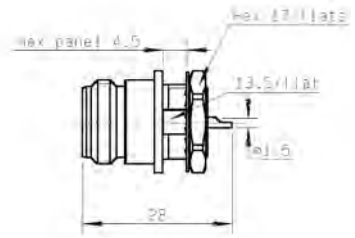

Fig. 2

Part number	Fig.	Captive center contact	Panel drilling
R162 403 000	1	Yes	P05
R162 570 000	2		P12

IN SERIES ADAPTERS

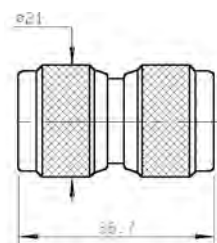

Fig. 1

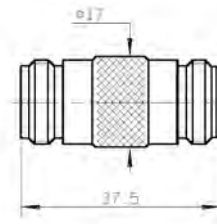
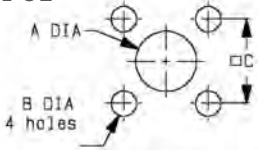

Fig. 2

Part number	Fig.	Captive center contact
R162 703 000	1	Yes
R162 705 000	2	

Panel Drilling

P01



	MM		INCH	
	maxi	mini	maxi	mini
A	16.3	16.1	0.642	0.634
B	3.30	3.20	0.13	0.126
C	18.35	18.15	0.722	0.715

P02



	MM		INCH	
	maxi	mini	maxi	mini
A	15.1	14.9	0.594	0.587
B	3.30	3.20	0.13	0.126
C	18.35	18.15	0.722	0.715

P03

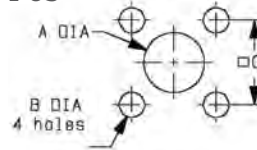

	MM		INCH	
	maxi	mini	maxi	mini
A	9.40	9.20	0.37	0.362
B	3.30	3.20	0.13	0.126
C	12.8	12.6	0.504	0.496

P04



	MM		INCH	
	maxi	mini	maxi	mini
A	4.2	4.1	0.165	0.161
B	3.3	3.2	0.13	0.126
C	18.35	18.15	0.722	0.715

P05

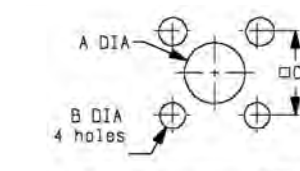

	MM		INCH	
	maxi	mini	maxi	mini
A Front	16.3	16.1	0.642	0.634
A Rear	15.1	14.9	0.594	0.587
B	3.30	3.20	0.13	0.126
C	18.35	18.15	0.722	0.715

P06

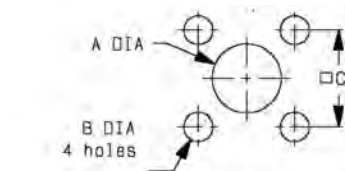

	MM		INCH	
	maxi	mini	maxi	mini
A Front	16.3	16.1	0.642	0.634
A Rear	4.2	4.1	.165	0.161
B	3.3	3.2	0.13	0.126
C	18.35	18.15	0.722	0.715

P07

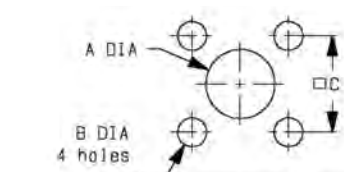

	MM		INCH	
	maxi	mini	maxi	mini
A Front	16.3	16.1	0.642	0.634
A Rear	12.5	12.3	0.492	0.484
B	3.3	3.2	0.13	0.126
C	18.35	18.15	0.722	0.715

P08

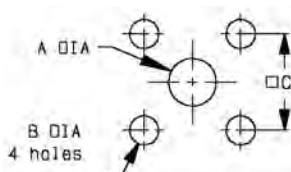

	MM		INCH	
	maxi	mini	maxi	mini
A	4.2	4.1	0.165	0.161
B	2.7	2.6	0.106	0.102
C	8.69	8.59	0.342	0.338

P09

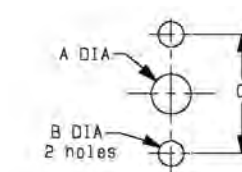

	MM		INCH	
	maxi	mini	maxi	mini
A	5	4.80	0.197	0.189
B	3.30	3.20	0.13	0.126
C	18.1	17.9	0.713	0.705

P10

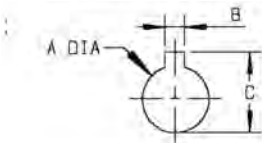

	MM		INCH	
	maxi	mini	maxi	mini
A	14.3	14.1	0.563	0.555
B	2.30	2.20	0.091	0.087
C	17	16.8	0.669	0.661

P11

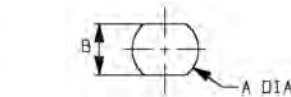

	MM		INCH	
	maxi	mini	maxi	mini
A	16.1	16	0.634	0.63
B	13.7	13.6	0.539	0.535

P12

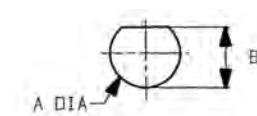

	MM		INCH	
	maxi	mini	maxi	mini
A	14.3	14.1	0.563	0.555
B	13.8	13.6	0.543	0.535

P13

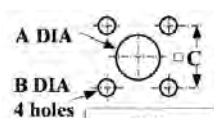

	mm	
	Maxi	mini
A	4.25	4.15
B	3.4	3.2
C	12.8	12.6

## Introduction



50Ω	DC - 11 GHz (standard and TNC Self-Lock) DC - 18 GHz (TNC 18 GHz)
75Ω	DC - 1.5 GHz DC - 1 GHz (recommended)
50 and 75Ω	DC - 1.5 GHz (commercial)

**GENERAL**

- Screw-on equivalent to BNC bayonet series
- Good RF performance
- Suitable for high power levels
- Long life and high strength
- 4 ranges:
  - Standard TNC series (50 and 75Ω fully intermateable)
  - Commercial TNC series (50 and 75Ω)
  - 18 GHz TNC series (50Ω)
  - TNC Self-Lock series 50 ohms

**APPLICABLE STANDARDS**

- MIL-C-39012 / MIL STD 348A/313
- IEC 60169-17
- CECC 22200

**APPLICATIONS**

- Avionics
- Aeronautics
- Countermeasures
- Telecommunications

**TNC Self-Lock is the latest addition to the TNC range**

TNC Self-Lock plugs are designed for civil aerospace applications. They are qualified for use in harsh and high vibration environments. Their specific anti-rotation coupling nut eliminates the need for safety lock wire, which results in significant time savings during installation on board the aircraft. They are fully compatible with all standard TNC receptacles and adapters.

Interface

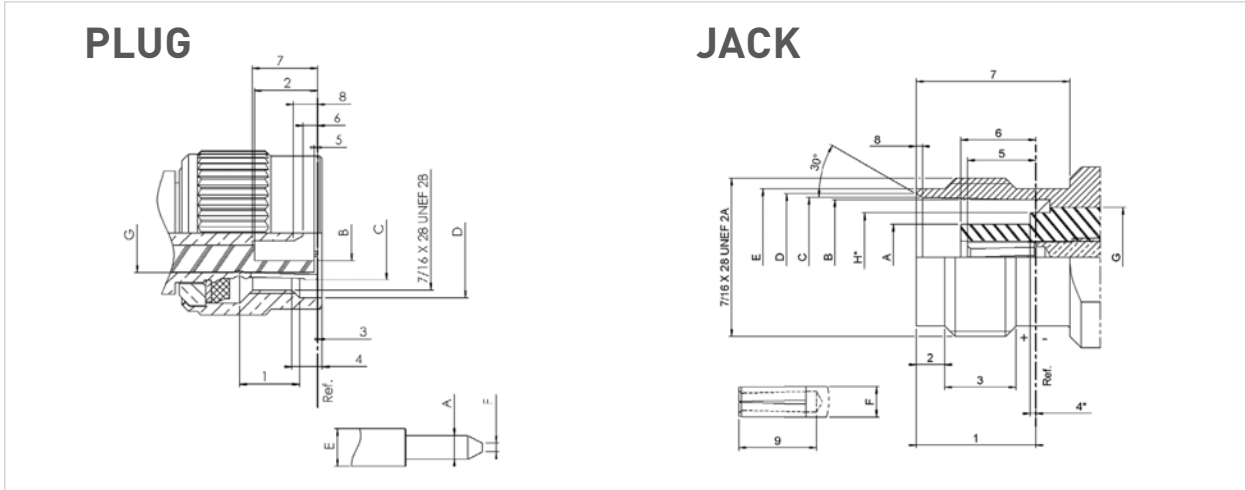

Letter	mm		inch	
	min.	max.	min.	max.
A	1.32	1.37	0.052	0.054
B	4.83	-	0.190	-
D	11.40	-	0.449	-
E	-	2.20	-	0.087
F	0.35	0.65	0.014	0.025
G	7.00	7.05	0.275	0.277
1	4.9	5.70	0.193	0.224
2	5.28	5.79	0.208	0.228
3	0.15	-	0.006	-
4	1.8	-	0.071	-
5	0.15	-	0.006	-
6	0.08	1.02	0.003	0.040
7	5.33	5.84	0.210	0.230
8	0.70	1.98	0.027	0.078

Letter	mm		inch	
	min.	max.	min.	max.
A	-	4.72	-	0.186
B	8.10	8.10	0.319	0.321
C	8.31	8.46	0.327	0.333
D	8.79	9.04	0.346	0.356
E	9.60	9.68	0.378	0.381
F	-	2.20	-	0.087
H	-	5.90	-	0.232
1	8.30	8.50	0.327	0.335
2	1.73	2.24	0.068	0.088
3	4.75	-	0.187	-
4	-	0.15	-	0.006
5	4.72	5.23	0.186	0.206
6	4.78	5.28	0.188	0.208
7	10.7	-	0.421	-
8	0.38	0.76	0.015	0.030
9	4.95	-	0.195	-

## Characteristics

Test / Characteristics	MIL-C-39012 A	Values / Remarks
------------------------	---------------	------------------

## ELECTRICAL CHARACTERISTICS

Impedance	-	50Ω	75Ω
Frequency range	-	DC - 11 GHz	DC - 1.5 GHz
V.S.W.R.	3-14	1.30 max	
Insertion loss	3-27	0.18 dB max at 9 GHz	
RF leakage	3-26	-60 dB min from 2 to 3 GHz	
Insulation resistance	3-11	5000 MΩ min	
Contact resistance	3-16	Initial	After proof
• Center contact (mΩ)	-	1.5	2
• Outer contact (mΩ)	-	0.2	-
Working voltage	-	At sea level: 500 V rms	at 70000 ft (21000 m): 125 V rms
Dielectric withstanding voltage	3-17	At sea level: 1500 V rms	at 70000 ft (21000 m): 375 V rms
RF withstanding voltage	3-23	At sea level: 1000 V rms (5 MHz sine wave)	

## MECHANICAL CHARACTERISTICS

Durability	3-15	500 matings	
Mating / unmating	-	Axial force: not applicable Torque: 1.96 inch pounds (22.6 N.cm)	
Recommended mating torque	-	3.99 to 5.98 inch pounds (46 to 69 N.cm)	
Proof torque	-	14.74 inch pounds (170 N.cm)	
Coupling mechanism retention force	3-25	100 Lbf (44.5 daN)	
Cabling retention force	3-24	Cable clamp:	40.6 Lbf (181 N min) [all cables]
		Crimped:	51 Lbf (227 N min) [cable dia. .189 (4.8) to .228 (5.8)] 76.4 Lbf (340 N min) [cable dia. .250 (6.35) and above]
Center contact retention	-	Axial: 6.06 Lbf (27 N)	

## ENVIRONMENTAL CHARACTERISTICS

Temperature range	-	-65°C / +165°C
• Standard models	-	-65°C / +100°C
• Hermetic sealed models	-	-65°C / +105°C
• Models for semi-rigid cables	-	
Thermal shock	3-20	MIL-STD-202, method 107, condition B
High temperature endurance	-	MIL-STD-202, method 108
Corrosion (salt spray)	3-13	MIL-STD-202, method 101, condition B
Vibrations	3-18	MIL-STD-202, method 204, condition B
Shocks	3-19	MIL-STD-202, method 213, condition G
Moisture resistance	3-21	MIL-STD-202, method 106
Low pressure	3-22	Not applicable
Hermetic seal	-	Applied vacuum 10 <sup>-6</sup> mm of Hg (Torrs) leakage rate < 10 <sup>-6</sup> atm/cm <sup>3</sup> /s
Leakage	-	Pressure 3.5 bars; duration 2 min; temperature 15°C to 25°C

## MATERIALS AND PLATING

Body and center pin contact	Brass as per QQ-B-626	Nickel plated
Center socket contact	Beryllium copper as per QQ-C-530	Gold plated
Ferrules	Brass	-
Insulators	PTFE teflon	-
Gaskets	Silicone elastomer	-

All dimensions are given in mm.

## Characteristics Commercial TNC

Test / Characteristics	Values / Remarks
------------------------	------------------

## ELECTRICAL AND ENVIRONMENTAL CHARACTERISTICS

Impedance	50Ω or 75Ω
Frequency range	DC - 1.5 GHz
Test voltage	1500 V rms
Operating voltage	500 V rms
Insulation resistance	5000 MΩ min (500 V)
Contact resistance	10 mΩ max
Temperature range	-35°C / +70°C

## PLATING

Body	Nickel
Center contacts	Gold

Plugs

STRAIGHT PLUGS CRIMP TYPE FOR FLEXIBLE CABLE

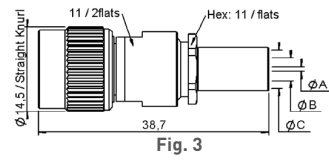
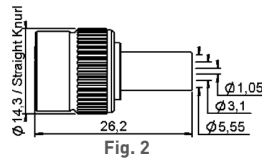
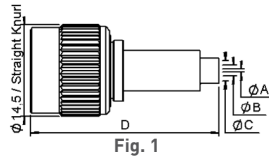

Cable group	Cable group dia.	Part number	Fig.	Dimensions mm				Captive center contact	Packaging	Note
				A	B	C	D			
RG174 / RG316 / AEP-100FR	2.6/50/S & LMR® 100	R143 075 000	1	0.6	1.75	3.25	29.6	Yes	100 pieces	-
AEP-195FR	LMR® 195	R143 082 027		1.05	3.1	5.55	26.6			Crimp type
AEP-200FR	LMR® 200	R143 082 200		1.27	3.1	5.55	26.6			
AEP-240FR	LMR® 240	R143 084 161		1.5	4.05	6.6	28.2			
AEP-400FR	LMR® 400	R143 089 117		2.85	7.8	11.05	27.85			
RG58 / RG141	5/50/S	R143 082 000	2	-	-	-	-	No	Unit	Full crimp
		R143 082 161		-	-	-	-			Commercial version, full crimp
		R143 072 000	3	1.05	3.1	5.55	-			
R143 073 000	3.075	5.5		-						
RG142 / RG223 / RG400	5/50/D	R143 083 000	1	1.05	3.1	5.5	26.6	Yes		-

STRAIGHT PLUGS CLAMP TYPE FOR FLEXIBLE AND SEMI RIGID CABLE

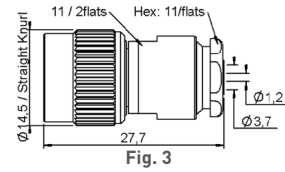
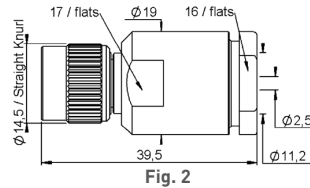
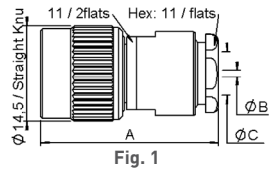

Cable group	Cable group dia.	Part number	Fig.	Dimensions mm			Captive center contact	Packaging	Note
				A	B	C			
RG174 / RG316 / RD316 RG179 / RD179	2.6/50+75	R143 004 000	1	26.5	0.6	3.1	Yes	Unit	-
RG58 / RG141 / RG142 RG223 / RG400	5/50/S+D	R143 008 000		27.1	1.2	5.6	No	100 pieces	Conical braid clamp
RG59 / RG62	6/75+93	R143 012 000		27	1.05	6.65			
RG213 / RG393 / RG214	10+11/50	R143 018 000	2	-	-	-	Yes	Unit	Safety coupling nut
		R143 018 500		-	-	-			
RG402	.141"	R143 052 000	3	-	-	-	No		-



Plugs and Jacks

RIGHT ANGLE PLUGS CRIMP AND SOLDER TYPE

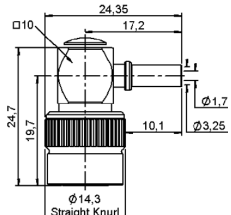

Fig. 1

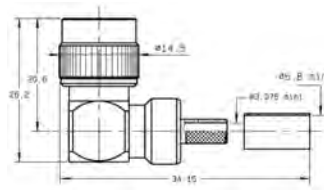

Fig. 2

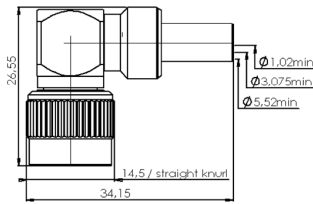

Fig. 3

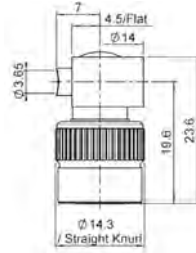
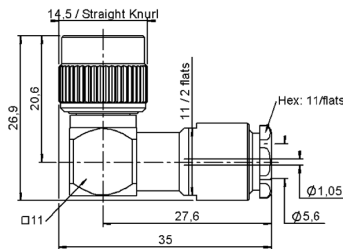

Fig. 4

Cable group	Cable group dia.	Part number	Fig.	Captive center contact	Packaging	Note
RG174 / RG316	2.6/50/S	R143 181 161	1	Yes	100 pieces	Commercial version
RG58 / RG141	5/50/S	R143 182 000	3			-
RG142 / RG223 / RG400	5/50/D	R143 183 000	2		Unit	-
RG402	.141"	R143 154 100	4		100 pieces	Solder Type

RIGHT ANGLE PLUG CLAMP TYPE, FOR FLEXIBLE CABLE



Cable group	Cable group dia.	Part number	Captive center contact	Packaging
RG58 / RG141 / RG142 / RG223 / RG400	5/50/S+D	R143 156 000	Yes	Unit

STRAIGHT JACKS CRIMP TYPE, FOR FLEXIBLE CABLE

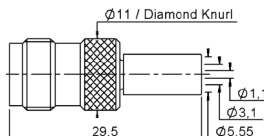

Fig. 1

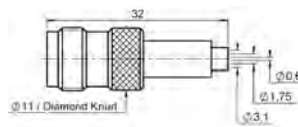

Fig. 2

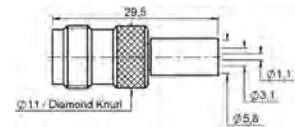

Fig. 3

Cable group	Cable group dia.	Part number	Fig.	Captive center contact	Packaging	Note
RG174 / RG316 / RD316	2.5/60 S + D	R143 237 000	2	Yes	Unit	-
RG58 / RG141	5/50/S	R143 235 161	1		100 pieces	Commercial version, Full crimp
RG142 / RG223 / RG400	5/50D	R143 236 020	3		Unit	-



Jacks

**STRAIGHT BULKHEAD JACKS CRIMP TYPE, FOR FLEXIBLE CABLE**

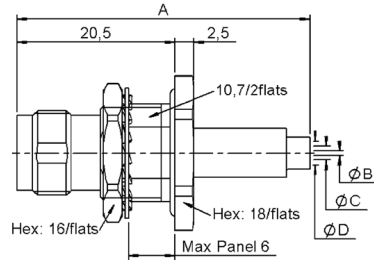

Cable group	Cable group dia.	Part number	Dimensions mm				Captive center contact	Panel drilling	Packaging	Note
			A	B	C	D				
RG174 / RG316	2.6/50/S	R143 331 161	38	0.6	1.75	3.10	Yes	P08+P10	100 pieces	Commercial version, Panel sealed
RG58 / RG141	5/50/S	R143 332 161	35	1.05	3.10	5.55				Commercial version, Panel sealed, Full crimp

**STRAIGHT JACKS CLAMP TYPE, FOR FLEXIBLE CABLE**

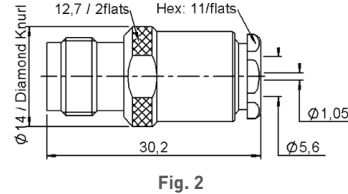
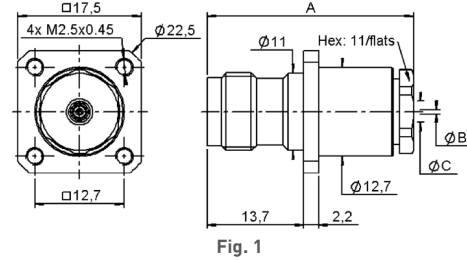

Fig. 2



Fig. 1

Cable group	Cable group dia.	Part number	Fig.	Dimensions mm			Captive center contact	Panel drilling	Packaging	Note
				A	B	C				
RG174 / RG316 / RD316 / RG179 / RD179	2.6/50+75	R143 254 000	1	29.8	0.6	3.1	Yes	P04	Unit	Square flange Also for screws type 3-56 UNF 2A
RG58 / RG141 / RG142 / RG223 / RG400	5/50/S+D	R143 258 000		30.2	1.05	5.6				
RG58 / RG141	5/50/S	R143 207 000	2	-	-	-	No	-	-	-

**SQUARE FLANGE STRAIGHT JACK SOLDER TYPE, FOR SEMI-RIGID CABLE**

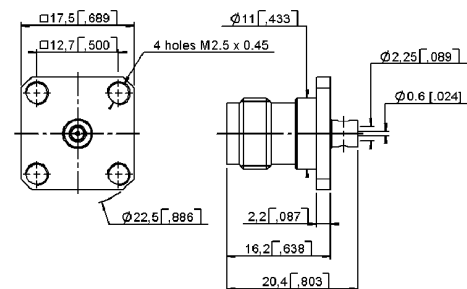

Cable group	Cable group dia.	Part number	Captive center contact	Panel drilling	Packaging
RG405	.085"	R143 257 440	No	P01	Unit

Jacks and Receptacles

STRAIGHT BULKHEAD JACKS PANEL SEALED

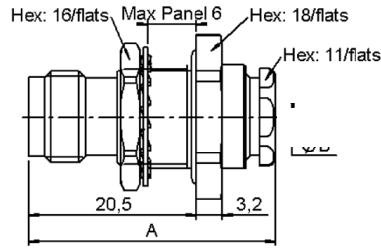

Fig. 1

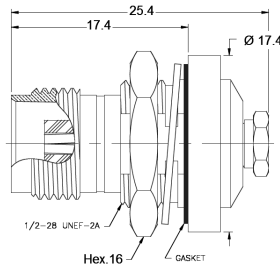

Fig. 2

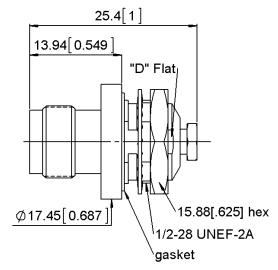

Fig. 3

Cable group	Cable group dia.	Part number	Fig.	Dimensions A (mm)	Captive center contact	Panel drilling	Note
RG178 / RG196	2/50/S	R143 323 000	1	29.9	Yes	P08	Rear mount
RG174 / RG316 / RD316	2.6/50	R143 324 000		29.6			
RG58 / RG141	5/50/S	R143 325 000		30.17			
RG402	.141"	R143 327 000		30.8			
RG174 / RG316	2.6/50S	6001-7051-003	2	-	Yes		Front mount
RG405	.085"	6001-7041-010		-			
RG178 / RG196	2/50S	6002-7051-002	3	-	Yes		
RG178 / RG196	2/50S	6002-7551-202		-			
RG174 / RG316	2.6/50S	6002-7051-003		-			
RD316	2.6/50D	6002-7551-219		-			
RG58 / RG141	5/50S	6002-7551-106		-			

SQUARE FLANGE STRAIGHT FEMALE RECEPTACLES

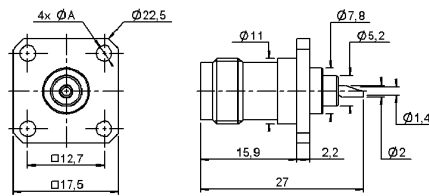

Fig. 1

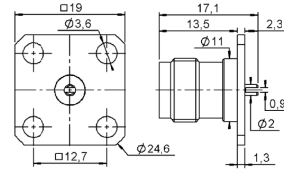

Fig. 2

Part number	Fig.	Dimensions A (mm)	Captive center contact	Panel drilling	Packaging	Note
R143 404 000	1	M2.5 x 0.45	Yes	P05	Unit	Solder pot 17.5 mm square flange
R143 405 000		2.6			100 pieces	
R143 420 000	2	-	No	P02	-	Slotted contact 19 mm square flange

BULKHEAD STRAIGHT FEMALE RECEPTACLES

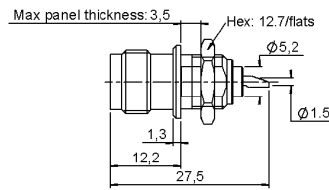

Fig. 1

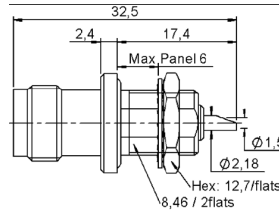

Fig. 2

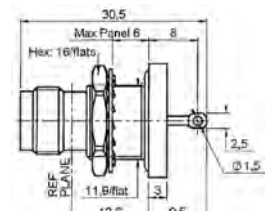
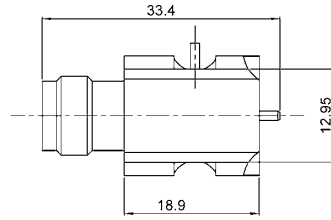

Fig. 3

Part number	Fig.	Captive center contact	Panel drilling	Packaging	Note
R143 557 000	1	Yes	P07	Unit	Front mount, Solder pot contact
R143 603 000	2		P09		Panel sealed, Front mount, Solder pot contact
R143 626 000	3		P11		Hermetic, Panel sealed, Rear mount

Receptacles and Caps

RF POWER SWITCHING CONNECTORS



Part number	Type
R143 422 947	Left
R143 422 957	Right

SQUARE FLANGE RIGHT ANGLE FEMALE RECEPTACLE

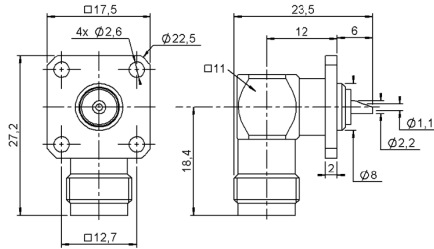

Part number	Captive center contact	Panel drilling	Packaging	Note
R143 654 000	Yes	P06	Unit	Solder pot contact

SQUARE FLANGE STRAIGHT MALE RECEPTACLE

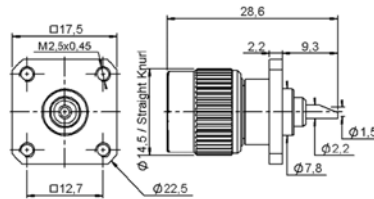

Part number	Captive center contact	Panel drilling	Packaging	Note
R143 440 000	Yes	P03	Unit	Solder pot contact

PROTECTIVE CAPS

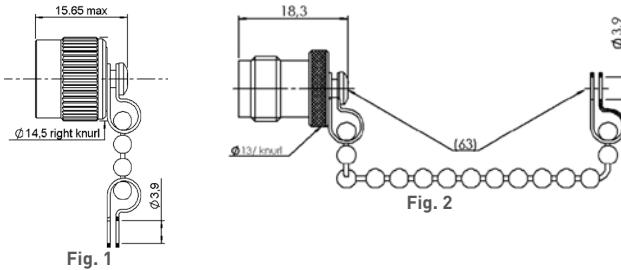

Part number	Fig.	Finish	Packaging	Note
R143 812 000	1	Nickel	Unit	Male with chain
R143 835 000	2		100 pieces	Female with chain

Adapters

IN SERIES ADAPTERS

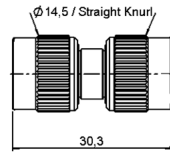

Fig. 1

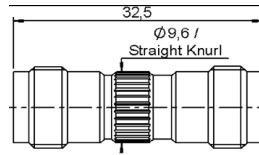

Fig. 2

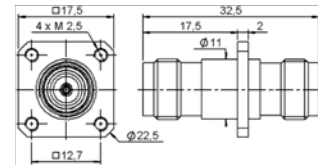

Fig. 3

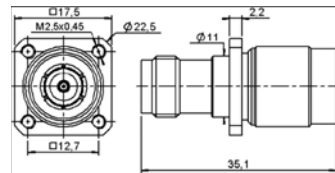

Fig. 4

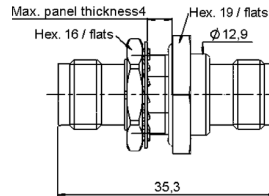

Fig. 5

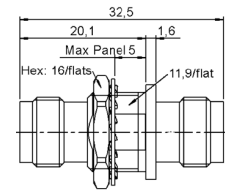

Fig. 6

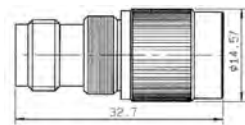

Fig. 7

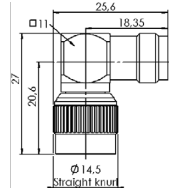

Fig. 8

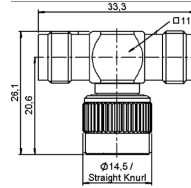

Fig. 9

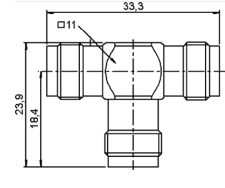
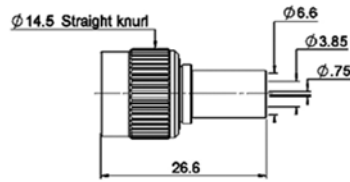

Fig. 10

Part number	Fig.	Captive center contact	Panel drilling	Packaging	Note
R143 703 000	1	Yes	-	Unit	Male - Male
R143 704 000	2				Female - Female
R143 710 000	3				Square flange female - Female
R143 713 000	4				Square flange slide on type male - Female
R143 753 000	5			100 pieces	Bulkhead hermetic, Panel sealed female - Female
R143 720 000	6				Commercial version, Bulkhead female - Female
R143 713 200	7			Unit	Female - Male push-on
R143 770 000	8				Right angle male - Female
R143 780 000	9				Female - Female - Male
R143 782 000	10				Female - Female - Female

Plugs and Jacks

**STRAIGHT PLUGS CRIMP TYPE FOR FLEXIBLE CABLE**



Cable group	Cable group dia.	Part number	Captive center contact	Note
RG59 / RG62	6/75 + 93	R144 085 000	No	Full crimp
		R144 085 161	Yes	Commercial version - Full crimp

**STRAIGHT BULKHEAD JACK CRIMP TYPE FOR FLEXIBLE CABLE**

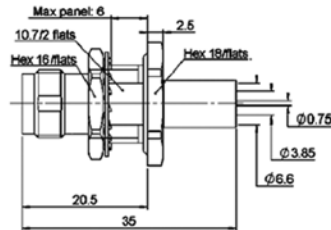

Cable group	Cable group dia.	Part number	Captive center contact	Panel drilling	Packaging	Note
RG59 / RG62	6/75 + 93	R144 334 161	Yes	P08 or P10	100 pieces	Commercial version Panel sealed

Panel Drilling

P01

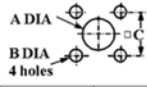

	MM		INCH	
	maxi	mini	maxi	mini
A	11.3	11.2	0.445	0.441
B	2.7	2.6	0.106	0.102
C	12.75	12.65	0.502	0.498

P02

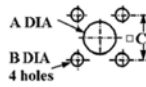

	MM		INCH	
	maxi	mini	maxi	mini
A	11.3	11.2	0.445	0.441
B	3.7	3.6	0.146	0.142
C	12.75	12.65	0.502	0.498

P03

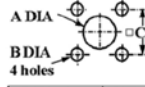

	MM		INCH	
	maxi	mini	maxi	mini
A	7.9	7.8	0.311	0.307
B	2.7	2.6	0.106	0.102
C	12.75	12.65	0.502	0.498

P04

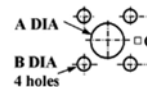

	MM		INCH	
	maxi	mini	maxi	mini
A (F. Mount)	13	12.9	0.512	0.508
A (R. Mount)	11.3	11.2	0.445	0.441
B	2.7	2.6	0.106	0.102
C	12.75	12.65	0.502	0.498

P05

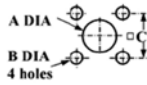

	MM		INCH	
	maxi	mini	maxi	mini
A F.mount	8	7.9	0.315	0.311
A R.mount	11.3	11.2	0.445	0.441
B	2.8	2.7	0.11	0.106
C	12.75	12.65	0.502	0.498

P06

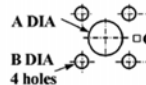

	MM		INCH	
	maxi	mini	maxi	mini
A	8.3	8.2	0.327	0.323
B	2.7	2.6	0.106	0.102
C	12.75	12.65	0.502	0.498

P07



	MM		INCH	
	maxi	mini	maxi	mini
A	9.8	9.7	0.386	0.382
B	8.93	8.81	0.352	0.347

P08

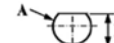

	MM		INCH	
	maxi	mini	maxi	mini
A	12.8	12.7	0.504	0.5
B	12.1	12	0.476	0.472

P09

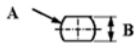

	MM		INCH	
	maxi	mini	maxi	mini
A	9.75	9.65	0.384	0.38
B	8.65	8.55	0.341	0.337

P10

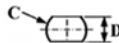

	MM		INCH	
	maxi	mini	maxi	mini
C	12.8	12.7	0.504	0.5
D	10.9	10.8	0.429	0.425

P11

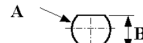

	mm	
	Maxi	mini
A	12.9	12.8
B	12.1	12

Introduction



50Ω	DC - 11 GHz (maximum) DC - 3 GHz (optimized)
-----	---

GENERAL

- Standard coaxial connectors
- Bayonet coupling

APPLICABLE STANDARDS

- MIL-C-39012 A
- MIL-C-3898 A
- MIL-C-23329 A
- IEC 169-7

APPLICATIONS

- Civil aerospace
- Maintenance

Type C connectors were engineered in the late 1940s. It is similar to type N but with a bayonet coupling for rapid connection and disconnection.

Interface

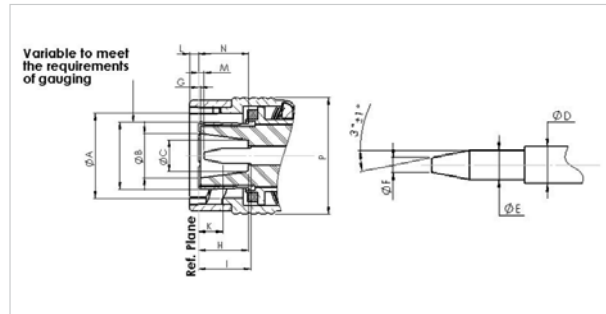
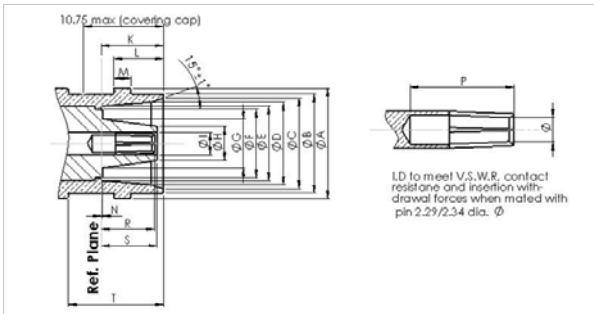

CEI Dimensions (in mm)

	Jack			Plug	
	min	max		min	max
ØA	14.99	15.24	ØA	13.79	13.94
ØB	13.46	13.72	ØB	7.01	-
ØC	12.32	12.57	ØC	4.92	-
ØD	11.18	11.43	ØD	3.02	3.15
ØE	10.44	10.54	ØE	2.29	2.34
ØF	-	9.50	ØF	-	1.27
ØG	-	6.91	ØG	0.18	-
ØH	-	4.83	ØH	7.80	8.56
ØI	3.02	3.15	ØI	7.85	-
K	8.43	8.59	K	4.85	6.38
L	7.80	7.95	L	-	2.16
M	2.24	2.49	M	0.09	1.02
N	-	0.18	N	7.54	7.72
P	7.62	-	P	-	19.84
Q	-	-	-	-	-
R	6.93	7.70	-	-	-
S	-	7.85	-	-	-
T	12.57	-	-	-	-

## Characteristics

Test / Characteristics	Values / Remarks
------------------------	------------------

### ELECTRICAL CHARACTERISTICS

Impedance	50Ω
Frequency range	DC - 3 GHz (optimized) DC - 11 GHz (maximum)
V.S.W.R.	1.22 at 3 GHz
Test voltage at sea level	3 Kv continuous
Insulation resistance	> 5000 MΩ

### MECHANICAL CHARACTERISTICS

Durability	500 matings
Vibrations	10g (acceleration) 10 to 500 Hz

### ENVIRONMENTAL CHARACTERISTICS

Temperature range	-55°C / + 155°C
Salt spray	48H
Panel sealing	Pressure: 3 bars Leakage rate < 1 cm <sup>3</sup> /h

### MATERIALS AND PLATING

Component	Material	Plating
Outer contact	Bronze	Gold
Connector body	Brass / Stainless steel	Nickel / Passivated
Insulator	PTFE	-
Gaskets	Silicone rubber	-



Plugs and Jacks

STRAIGHT PLUGS, FOR FLEXIBLE CABLE

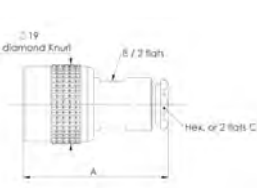

Fig. 1

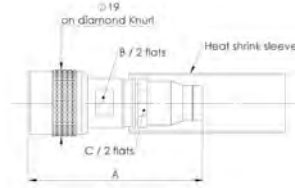

Fig. 2

Cable group	Cable group dia.	Part number	Fig.	Dimensions			Captive center contact	Note
				A	B	C		
RG58 / RG141	5/50/S	R166 005 000	1	35	11	11	No	Clamp type
RG213 / RG214	10/50/S 11/50/D	R166 018 000	1	38	16	16		
ASNE WD+WN	8/50	R166 092 190	2	50.25	12	12	Yes	Crimp type
F1703-93	4.3/50/D	R166 093 000		49.5	10	8	No	
Special ASNE	5/50/D	R166 094 000		46.45	12	12		
ASNE WZ	3.6/50S	R166 088 100		42.55	12	8		

RIGHT ANGLE PLUGS, FOR FLEXIBLE CABLE

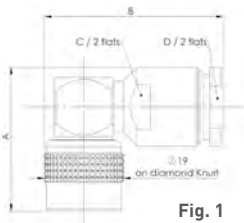

Fig. 1

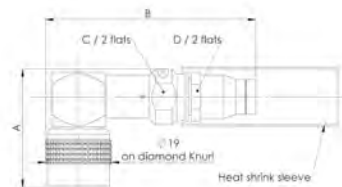

Fig. 2

Cable group	Cable group dia.	Part number	Fig.	Dimensions				Captive center contact	Note
				A	B	C	D		
Special	7/50/D	R166 160 020	1	31.3		15.8	16	Yes	Clamp type
RG213 / RG214	10/50/S 11/50/D	R166 168 000		34.5	43	16	16		
F1703-93	4.3/50/D	R166 191 000	2	34.3	52.6	14	12	No	Crimp type
ASNE WD+WN	8/50	R166 194 190		34.3	60.8	14	12		

STRAIGHT JACKS, FOR FLEXIBLE CABLE

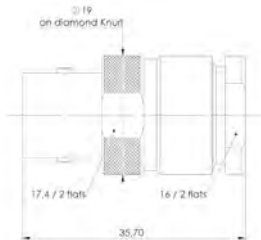

Fig. 1

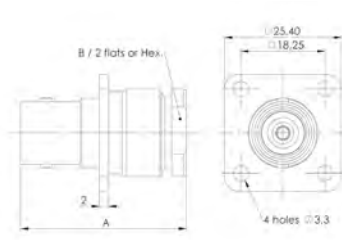
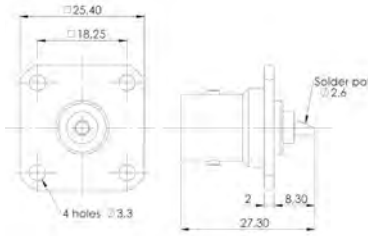

Fig. 2

Cable group	Cable group dia.	Part number	Fig.	Dimensions		Captive center contact	Note
				A	B		
RG213 / RG214	10/50/S 11/50/D	R166 218 000	1			No	Clamp type
Special ASNE	5/50/D	R166 256 000	2	32	12.7		
RG213 / RG214	10/50/S 11/50/D	R166 268 000			35.7	19	

## Receptacles and In Series Adapters

### SQUARE FLANGE, STRAIGHT FEMALE RECEPTACLES



Part number	Captive center contact	Panel drilling	Finish
R166 404 000	Yes	P01	Brass / Nickel
R166 404 001			Stainless steel passivated

### IN SERIES ADAPTERS

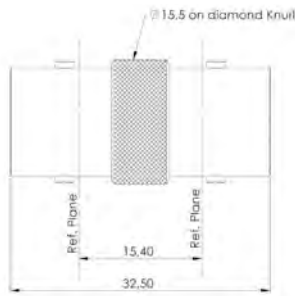

Fig. 1



Fig. 2

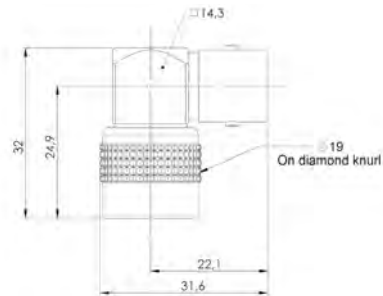
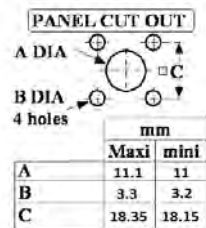

Fig. 3

Part number	Fig.	Panel drilling	Note
R166 705 000	1		Female - Female
R166 753 000	2	P02	Female - Female / Bulkhead / Hermetic
R166 770 000	3		Male - Female / Right angle

### Panel Drilling

#### P01



#### P02

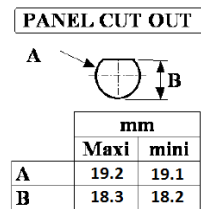



## SSMA/SSMB/SSMC

R121/R203/R202

**Contents****SSMA**

Introduction .....	12-4
Characteristics .....	12-4
Plugs .....	12-5
Receptacles .....	12-6
In series adapters .....	12-6

**SSMB**

Introduction .....	12-7
Characteristics .....	12-7
Plugs and jacks .....	12-8 to 12-9
Receptacles .....	12-9 to 12-11
In series adapters .....	12-11
Panel drilling .....	12-15

**SSMC**

Introduction .....	12-12
Characteristics .....	12-12
Plugs and jacks .....	12-13 to 12-14
Receptacles .....	12-14
In series adapters .....	12-14
Panel drilling .....	12-15

## Introduction



50Ω	DC - 18 GHz
DC-34 GHz possible	

**GENERAL**

- Miniature coaxial connectors
- Screw-on coupling
- High RF performance
- Reduced weight and size

**APPLICABLE STANDARDS**

- CECC 22 160
- MIL-STD-348 fig.319

**APPLICATIONS**

- Military aeronautics
- Missiles
- Detection - countermeasures

**SPACE QUALIFIED APPROVAL**

- SCC 3402 (ESA)

Introduced in the 1960s, the SSMA series of connectors are of identical construction to the classic SSMA series but offer the benefit of reduced dimensions. They are recommended for use on equipment having limited component space availability combined with frequency requirements up to 34 GHz. Today, SSMA is mostly used for maintenance of existing equipment. For new projects, we advise using SMP or SMP-LOCK™ connectors.

## Characteristics

Test / Characteristics	Values / Remarks
------------------------	------------------

**ELECTRICAL CHARACTERISTICS**

Impedance	50Ω	
Frequency range	DC - 18 GHz	
VSWR	.085" / RG405 semi-rigid cable: 1.07 + 0.01 F (GHz)	
Insertion loss (typ.) dB	0.04 √F (GHz)	
RF leakage (min) dB	-90 + F (GHz)	
Insulation resistance	≥ 1000 MΩ	
Contact resistance	Center contact: 5mΩ max. / Outer contact: 2.5mΩ max.	
Voltage in V. Rms	Dielectric withstanding voltage	Working voltage
• At sea level	≥ 750 V.	≤ 250 V.
• At 70,000 ft	150 V.	65 V.

**MECHANICAL CHARACTERISTICS**

Durability	> 500 cycles
Force to engage / disengage	Torque 12 N.com (2 inch-pounds)
Recommended coupling not torque	60 to 80 N.com (5.3 to 7.1 inch-pounds)
Cable retention force	.085: / RG405 cable > 136 N (30lbf)
Center contact retention force	22N (5lbf) min.

**ENVIRONMENTAL CHARACTERISTICS**

Temperature range	- 55°C / +155°C - 55°C / +105°C
• Standard models	
• Semi-rigid cables	
Thermal cycling	MIL-STD-202, Method 102, Condition D
Vibration	MIL-STD-202, Method 204, Condition A, 10g
Shock	MIL-STD-202, Method 213, Condition A, 50g
Moisture resistance	MIL-STD-202, Method 106
Corrosion	MIL-STD-202, Method 101, Condition B

**MATERIALS AND PLATING**

	Material	Plating
Body/nut	Stainless steel / Brass	Gold or Passivated / BBR
Center contacts	Brass (male) / Beryllium copper (female)	Gold over Nickel
Gaskets	Silicon rubber	-
Insulators	PTFE	-

Plugs

**PLUGS FOR SEMI-RIGID CABLES, SOLDER TYPE**

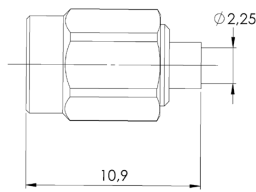

Fig. 1

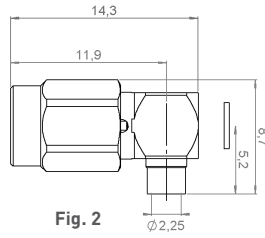

Fig. 2

Cable group	Cable group dia.	Part number (Gold)	Fig.	Captive center contact	Note
RG405	.085"	R121 053 000	1	Yes	Straight
		R121 153 000	2		Right angle

**PLUGS FOR FLEXIBLE CABLE, CRIMP TYPE**

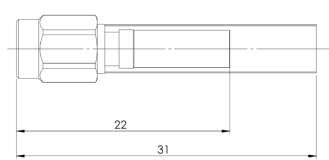

Fig. 1

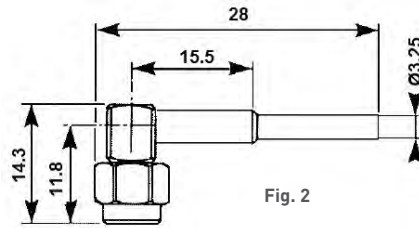

Fig. 2

Cable group	Cable group dia.	Part number (Gold)	Fig.	Captive center contact	Note
RG174 / RG316	2.6/50S	R121 072 000	1	Yes	Straight - Heatshrink sleeve
		R121 172 000	2		Right angle - Heatshrink sleeve
		9765-9523-003			Right angle

Receptacles and Adapters

EXTENDED DIELECTRIC FEMALE RECEPTACLE

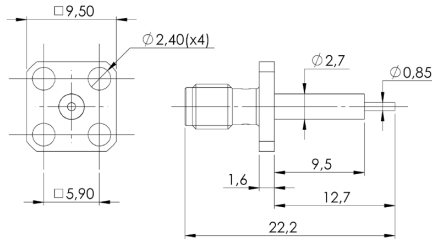
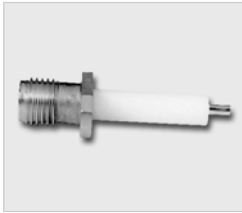

Fig. 1

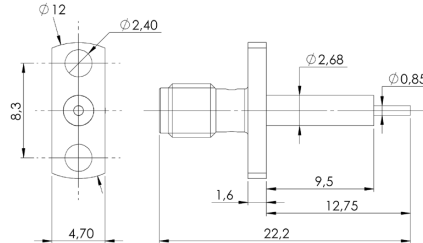
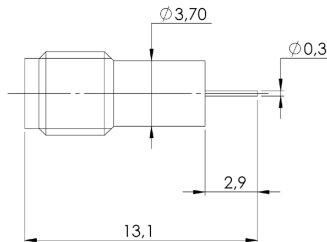

Fig. 2

Part number (Gold)	Fig.	Captive center contact	Panel drilling	Note
R121 414 000	1	Yes (epoxy)	NEW	Square flange
R121 464 000	2			Narrow flange

HERMETIC FEMALE RECEPTACLE



Part number (gold)	Captive center contact	Contact type	Note
R121 630 003	Yes	Cylindrical	Solder in type

IN SERIES ADAPTERS

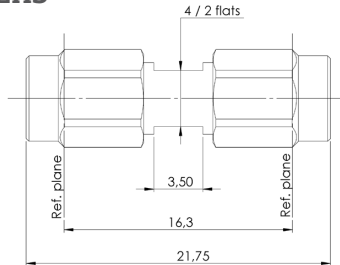

Part number (Gold)	Part number (Passivated)	Captive center contact	Finish	Note
R121 703 000	-	Yes	Nickel	Male - Male adapter
-	R121 705 001		Gold	Female - Female adapter

## Introduction

**GENERAL**

- DC - 12 GHz
- Impedance 50 $\Omega$
- Snap-on coupling
- Micro-miniature connectors
- Very low weight and size

**APPLICATIONS**

- Civil and military telecommunications
- Video equipment

**APPLICABLE STANDARDS**

- MIL-STD-348A
- IEC 169-19
- MIL-PRF-39012

SSMB is a small size version of SMB, developed in 1995.

## Characteristics

Test / Characteristics	Values / Remarks
------------------------	------------------

**GENERAL**

Impedance	50 $\Omega$
Frequency range	DC - 12.4 GHz
Temperature range	-65 $^{\circ}$ C to + 165 $^{\circ}$ C

**ELECTRICAL CHARACTERISTICS**

Insertion loss in dB	0.3VF (GHz)	
RF leakage	$\leq$ -55 dB at 1 GHz	
VSWR	RG 178 cable: 1.25 + 0.02F (GHz)	
Contact resistance	Center contact: 5m $\Omega$ max. Outer contact: 1m $\Omega$ max.	
Insulation resistance	1000M $\Omega$	
Voltage in VRMS	Dielectric withstanding voltage	Working voltage
• At sea level	$\geq$ 500V	$\leq$ 250V
• At 70,000 ft	100V	60V

**MECHANICAL CHARACTERISTICS**

Cable retention force	RG 174 : 50 N - RD 316 : 100 N
Mating endurance	500
Center contact retention force	$\geq$ 8 N
• Force to engage	$\leq$ 27 N
• Force to disengage	$\geq$ 8 N

**ENVIRONMENTAL CHARACTERISTICS**

Vibration	CEI60 169-19/68-2-6 (10g-10 to 500 Hz)
Shock	MIL-STD-202, Method 213, Condition B, 75g-6ms 1/2 sinus
Corrosion (salt mist)	MIL-STD-202, Method 101, Condition B (48h)

**MATERIALS AND PLATING**

	Material	Plating
Body	Brass	Gold
Contacts	Beryllium copper	Gold
Insulators	PTFE	-



## Plugs

## STRAIGHT PLUGS CRIMP TYPE, FOR FLEXIBLE CABLES

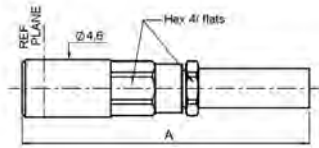

Cable group	Cable group dia.	Part number	Dimensions A (mm)	Captive center contact	Finish
RG178 / RG196	2/50S	7202-1572-002	17.8	Yes	Gold
RG174 / RG316 / RG179	2.6/50S	7202-1572-003			
RD316	2.6/50D	7202-1572-019			
RG178 / RG196	2/50/S	R203 073 000	23.3		
RG174 / RG316	2.6/50/S	R203 075 000			

## STRAIGHT PLUGS, SOLDER TYPE, FOR SEMI-RIGID CABLES

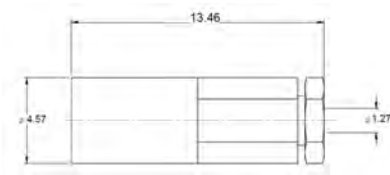

Cable group	Cable group dia.	Part number	Captive center contact	Finish
RG405	.085"	7202-1542-010	Yes	Gold
M17 / 151	.047"	7202-1542-011		

## RIGHT ANGLE PLUGS, CRIMP TYPE, FOR FLEXIBLE CABLES

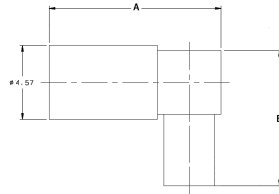

Cable group	Cable group dia.	Part number	Dimensions (mm)		Captive center contact	Finish	Note		
			A	B					
RG178 / RG196	2/50S	7405-1521-002	10.7	8.4	Yes	Gold	-		
RG174 / RG316	2.6/50S	7405-1521-003					-		
RD178	2/50D	7405-1521-005					-		
RD316	2.6/50D	7405-1521-019					-		
RG178 / RG196	2/50S	7405-2521-002	18.1	12.2		Gold + Nickel	-		
		R203 173 000					18.1	12.2	Heatshrink sleeve
		R203 173 080					10.7	9.4	Low profile
RG316	2.6/50+75	R203 175 000	12.2	13.6			Heatshrinks sleeve		

Plugs, Jacks and Receptacles

**RIGHT ANGLE PLUGS, SOLDER TYPE, FOR SEMI RIGID CABLES**

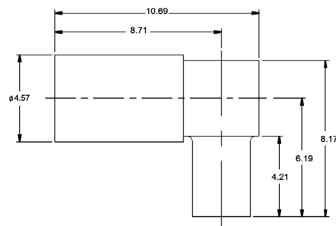

Cable group	Cable group dia.	Part number	Captive center contact	Finish
RG405	.085"	7405-1561-010	Yes	Gold
M17 / 151	.047"	7405-1561-011		

**STRAIGHT AND RIGHT ANGLE BULKHEAD JACKS CRIMP TYPE, FOR FLEXIBLE CABLE**

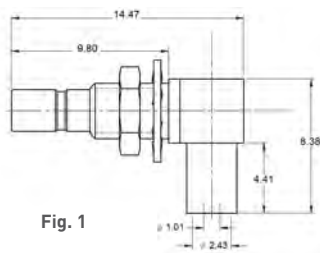
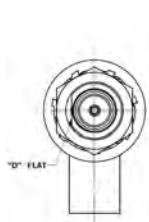

Fig. 1

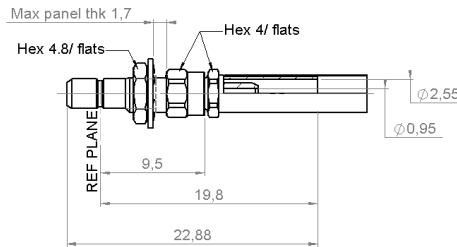
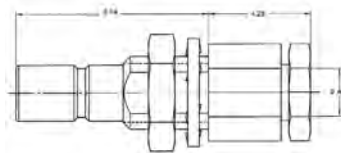

Fig. 2

Cable group	Cable group dia.	Part number	Fig.	Captive center contact	Panel drilling	Finish	Note
RG178 / RG196	2/50S	7406-1521-002	1	Yes	P01	Gold	Right angle Rear mount
RG174 / RG316	2.6/50S	7406-1521-003					
RD178	2/50D	7406-1521-005					
RG178 / RG196	2/50/S	R203 313 000	2				Straight rear mount

**STRAIGHT BULKHEAD JACK SOLDER TYPE, FOR SEMI-RIGID CABLE**



Cable group	Cable group dia.	Part number	Dimensions A (mm)	Captive center contact	Panel drilling	Finish
RG405	.085"	7203-1541-010	2.26	Yes	P01	Gold
M17 / 151	.045"	7203-1541-011	1.27			

**STRAIGHT BULKHEAD RECEPTACLES (male center contact)**

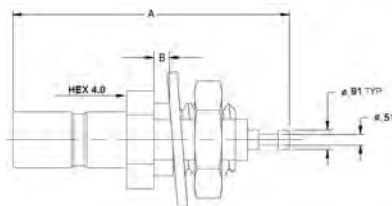

Part Number	Captive center contact	Dimensions (mm)		Panel drilling	Finish	Note
		A	B			
7204-1511-000	Yes	13.0	2.0	P01	Gold	Rear mount
7219-1511-000			1.7			Front mount
R203 553 00		13.3	1.7			

Receptacles

**RIGHT ANGLE PCB BULKHEAD RECEPTACLES (male center contact)**

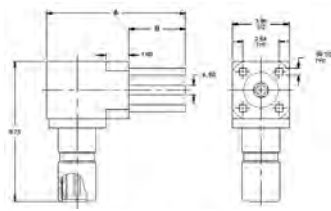

Part number	Captive center contact	Panel drilling	Finish	Dimensions		
				A	B	C
7410-1511-000	Yes	P01	Gold	14.5	12.5	9.8
7410-1511-012			Pretinned			
7410-1511-050			Gold			
7410-1511-040			Pretinned			

**STRAIGHT PCB RECEPTACLES (male center contact)**

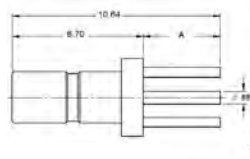
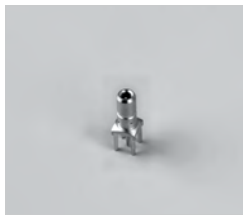

Fig. 1

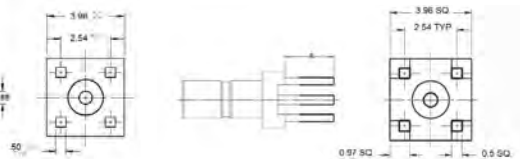

Fig. 2

Part number	Fig.	Captive center contact	Dimensions (mm) A	Panel drilling	Finish	Note
7209-1511-000	1	Yes	3.93	P02	Gold	No stand off
7209-1511-012			3.43			Pretinned legs, No stand off
7209-1511-011			0.0			-
7209-1511-015	2		3.43	P02		SMT version
7209-1511-040			3.2	-		Pretinned legs
7209-1511-050			-	-		-
R203 426 000		-	-	-	Body 3.5	

**STRAIGHT PCB RECEPTACLES (female center contact)**

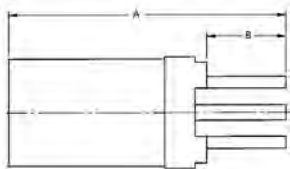

Fig. 1

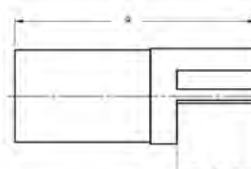
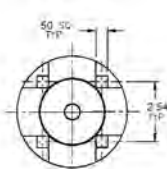

Fig. 2

Part number	Fig.	Captive center contact	Dimensions (mm)		Panel drilling	Finish	Note
			A	B			
7225-1512-000	1	Yes	12.0	3.93	P02	Gold	No stand off
7225-1512-012			12.0	3.93			Pretinned legs, No stand off
7225-1512-050			12.0	3.43			-
7225-1512-040			12.0	3.43			Pretinned legs
7225-1512-060	2		12.0	3.93	-		End launch version
7225-1512-004	1		8.7	0.0	-		SMT version

Receptacles

**RIGHT ANGLE PCB RECEPTACLES (male center contact)**

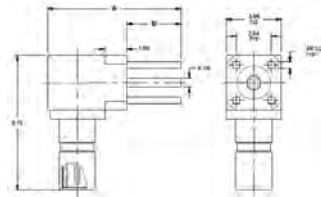

Fig. 1

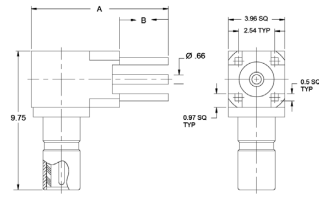
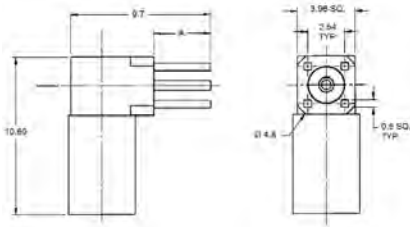

Fig. 2

Part number	Fig.	Captive center contact	Dimensions (mm)		Panel drilling	Finish	Note
			A	B			
7210-1511-000	1	Yes	9.65	3.93	P02	Gold	No stand off
7210-1511-012			6.27	0.0			Pretinned legs, No stand off
7210-1511-015			8.17	2.46			SMT version, No stand off
7210-1511-019			8.17	2.46	-		No standoff
7210-1511-040	2		9.65	3.42	P02	Gold	Pretinned legs
7210-1511-050			8.9	3.2			-
R203 665 000							

**RIGHT ANGLE PCB RECEPTACLES (female center contact)**



Part number	Captive center contact	Dimensions (mm)	Panel drilling	Finish	Note
		A			
7242-1511-000	Yes	3.93	P02	Gold	Pretinned legs
7242-1511-012		3.43			
7242-1511-050		3.43			

**IN SERIES ADAPTERS**

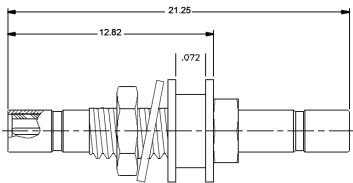

Part number	Captive center contact	Panel drilling	Finish	Note
7222-1501-600	Yes	P01	Gold	Bulkhead male - Male

**Introduction**

SSMC connectors are about a third smaller than SMC. They are mainly used in avionics, missiles, and any limited-space applications that require the security of a threaded coupling.

**GENERAL**

- DC - 12 GHz
- Impedance 50Ω
- Screw-on coupling
- Micro-miniature connectors
- Very low weight and small size

**APPLICATIONS**

- Civil avionics
- Military aerospace, missiles

**APPLICABLE STANDARDS**

- MIL STD 348A
- IEC 60169-20
- MIL-PRF-39012

**Characteristics**

Test / Characteristics	Values / Remarks
------------------------	------------------

**GENERAL**

Impedance	50Ω
Frequency range	DC - 12.4 GHz
Temperature range	-65°C to + 165°C

**ELECTRICAL CHARACTERISTICS**

Insertion loss in dB	0.3Vf (GHz)	
RF leakage	≤ -55 dB at 1 GHz	
VSWR max up to 4GHz	RG 178 cable: 1.20 + 0.02F (GHz)	
Contact resistance (inner contact)	Center contact: 5mΩ max. Outer contact: 1mΩ max.	
Insulation resistance	1000MΩ	
Voltage in VRMS <ul style="list-style-type: none"> <li>• At sea level</li> <li>• At 70,000 ft</li> </ul>	Dielectric withstanding voltage <ul style="list-style-type: none"> <li>≥ 500V</li> <li>100V</li> </ul>	Working voltage <ul style="list-style-type: none"> <li>≤ 250V</li> <li>60V</li> </ul>

**MECHANICAL CHARACTERISTICS**

Cable retention force	RG174: 50N - RG316: 100N
Mating endurance	500
Center contact retention force	≥ 8N

**ENVIRONMENTAL CHARACTERISTICS**

Vibration	MIL-STD-202, Method 204, Condition D (20g)
Shock	MIL-STD-202, Method 213, Condition B, 75g-6ms 1/2 sinus
Corrosion (salt mist)	MIL-STD-202, Method 101, Condition B (48h)

**MATERIALS AND PLATING**

	Material	Plating
Body	Brass	Gold
Contacts	Beryllium copper	Gold
Insulators	PTFE	-

Plugs

**STRAIGHT PLUGS FOR FLEXIBLE AND SEMI-RIGID CABLES**

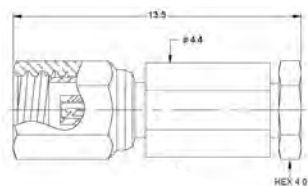

Fig. 1

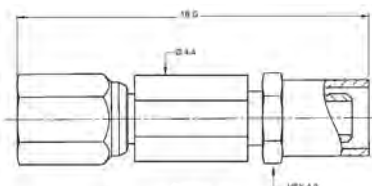
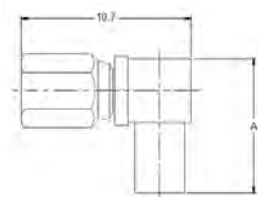

Fig. 2

Cable group	Part number	Fig.	Note	Finish
RG405	7002-1542-010	1	Solder type	Gold
M17 / 151	7002-1542-011			
RG178 / RG196	7002-1572-002	2	Crimp type	
RG174 / RG316	7002-1572-003			
RD316	7002-1572-019			
RG178 / RG196	7002-1571-002			
RG178 / RG196	7002-1571-003			
RD316	7002-1571-019			

**RIGHT ANGLE PLUGS FOR FLEXIBLE AND SEMI-RIGID CABLES**



Cable group	Cable group dia.	Part number	Dimensions (mm) A	Note
RG178 / RG196	2/50S	7105-1521-002	8.4	Crimp type
RG174 / RG316	2.6/50S	7105-1521-003		
RD316	2/50D	7105-1521-019		
RG405	.085"	7105-1561-010	8.2	Solder type
M17 / 151	.047"	7105-1561-011		

**STRAIGHT JACKS FOR FLEXIBLE AND SEMI-RIGID CABLES**

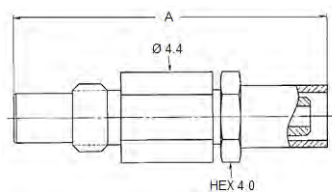

Cable group	Cable group dia.	Part number	Dimensions (mm) A	Note
RG178 / RG196	2/50S	7101-1571-002	16.0	Crimp type
RG405	.085"	7101-1541-010	8.8	Solder type

Jacks, Receptacles and Adapters

**BULKHEAD STRAIGHT AND RIGHT ANGLE JACKS FOR FLEXIBLE AND SEMI-RIGID CABLES**

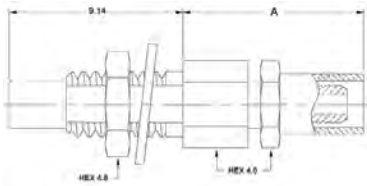

Cable group	Cable group dia.	Part number	Dimensions A(mm)	Panel drilling	Finish	Note
RG178 / RG196	2/50S	7003-1572-002	9.7	P01	Gold	Crimp type
RG174 / RG316	2.6/50S	7003-1572-003	9.7			Solder type
M17 / 151	.047"	7003-1542-011	4.8			

**PCB RECEPTACLES**

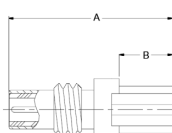

Fig. 1

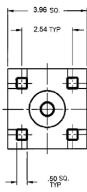

Fig. 2

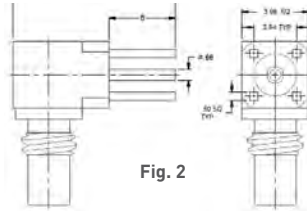
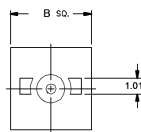
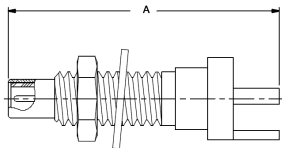

Fig. 3

Part number	Fig.	Dimensions (mm)		Panel drilling	Finish	Note	
		A	B				
7009-1511-000	1	10.6	4.0	P02	Gold	No stand off	
7009-1511-050		10.6	3.42			Stand off legs	
7009-1511-004		7.34	0	-		Stand off legs, SMT version	
7010-1511-000	2	9.65	4.0	P02	Gold, Pre-tinned legs	No stand off	
7010-1511-041			3.42				Stand off legs
7010-1511-050			3.42				Male center contact
7042-1511-040	3				Gold, Pre-tinned legs	No stand off, Bulkhead	
7110-1511-000	2		4.0		Gold	Stand off legs, Bulkhead	
7110-1511-050			3.42				

**END LAUNCH BULKHEAD RECEPTACLES**



Part number	Dimensions (mm)		Finish
	A	B	
7029-1511-031	17.52	5.25	Gold
7029-1513-005	14.85	6.35	
7029-1513-004		3.96	

**IN SERIES ADAPTERS**

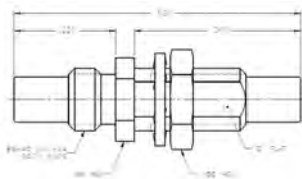

Part number	Captive center contact	Panel drilling	Finish	Note
7122-1502-000	Yes	P01	Gold	Bulkhead male - Male

Panel Drilling

PANEL DRILLING SSMB/SSMC

P01

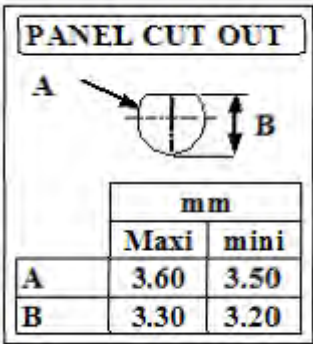

P02

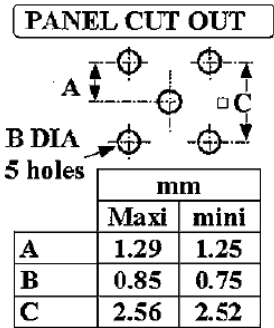

SSMB / SSMC



SIMPLIFICATION IS OUR INNOVATION

NOTE





## 4.1-9.5/4.3-10/QLI/7-16

R170/R183/R184/R185

**Contents**

**7/16**

Introduction..... 13-4 to 13-5  
 Interface ..... 13-6  
 Characteristics ..... 13-7 to 13-8  
 Plugs ..... 13-9  
 Jacks ..... 13-10 to 13-11  
 Receptacles..... 13-11  
 Adapters ..... 13-12  
 Caps..... 13-12

**COMPOSITE 7/16**

Introduction..... 13-4 to 13-5  
 Interface ..... 13-6  
 Characteristics ..... 13-8  
 Jacks ..... 13-13  
 Receptacles..... 13-13  
 Panel drilling ..... 13-14

**QLI**

Introduction..... 13-15  
 Characteristics ..... 13-16  
 Plugs ..... 13-17  
 Jacks ..... 13-17 to 13-18  
 Protective Cap ..... 13-18

**4.3-10**

Introduction..... 13-19  
 Characteristics ..... 13-20  
 Plugs ..... 13-21 to 13-22  
 Jacks ..... 13-22  
 Panel drilling ..... 13-22

**4.1-9.5**

Introduction..... 13-23  
 Characteristics ..... 13-24  
 Plugs ..... 13-25  
 Jacks ..... 13-25

**Introduction**

50Ω

DC - 7.5 GHz

**GENERAL**

- Standard coaxial connectors
- Screw-on coupling
- High power rating
- Excellent RF performance

**APPLICABLE STANDARDS**

- IEC 169-4
- DIN 47223
- CECC 22 190

**APPLICATIONS**

- Mobile communication infrastructure networks: combiner, diplexer, filter...
- Jumper and feeder cables assemblies
- Radio links
- Indoor and outdoor applications

Radiall's 7/16 series has been developed using the latest technology advances in connector design. These connectors are easy to use, highly reliable, innovative and are designed to meet the needs of the telecommunications market. The complete connector series feature the following characteristics:

- An extensive range, with optimized component part design
- An upgraded cross-knurled coupling nut allowing better manual tightening

**Composite 7/16**

Radiall expanded its line of innovative 7/16 composite connectors with jacks and receptacles as a lightweight, low cost alternative to brass connectors. Manufactured with corrosion-proof, composite materials these new single-piece connectors are UV resistant, meeting IEC 68-2-5 and IEC-68-2-9 to withstand all environments, including harsh outdoor installations. Radiall now offers over 20 different variations. The selection of the composite materials is a result of an in-depth competitive analysis of creeping speeds of zinc and aluminum alloys. Not only do the composite materials offer considerable performance advantages guaranteeing up to 500 matings; but with more than a 50% reduction in weight, this receptacle reduces the overall weight of the final module as well as transportation costs.

## Introduction

### High performance range

- Frequency range: DC - 7.5 GHz
- 2 types of coupling nut:
  - Cross-knurled and 6 flats 27 mm wide coupling nut (3 000 N.cm)
  - 6 flats coupling nut (32 mm wide), allowing high coupling torque (3 500 N.cm) when used with a torque wrench
- Intermodulation performance: 2 levels
  - 125 dBm cable assemblies
  - 110 dBm connectors and cable assemblies

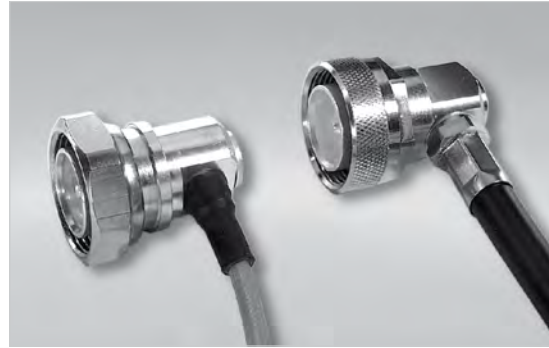

2 types of coupling nut

Radiall has developed its intermodulation measurement equipment following the IEC 46 D/292/NP standard proposal. It is aimed at third-order IMP measurements through the reflection method. The range of this test set-up is -132 dBm (-175 dBc) under 2 x 20 W.

- High performance non-magnetic material (brass) and plating (silver) with anti-tarnishing finish (strike of BBR)
- Non-slotted outer contact on standard products
- The 7/16 connector series benefits from a complete easy-to-use range of tooling



### Custom models

To fulfill customer requirements, Radiall offers complete design of custom connectors according to the 7/16 series standard.

### What is Intermodulation?

Intermodulation (IM) is an undesired modulation that leads to a distortion of the output high-frequency carrier. It is defined as the ratio of the 3rd order intermodulation products and the incident signal power because the most troublesome IM products are those of 3rd order.

For more detailed information, including our intermodulation measurement system and our product range, please visit [www.radiall.com](http://www.radiall.com)

Interface

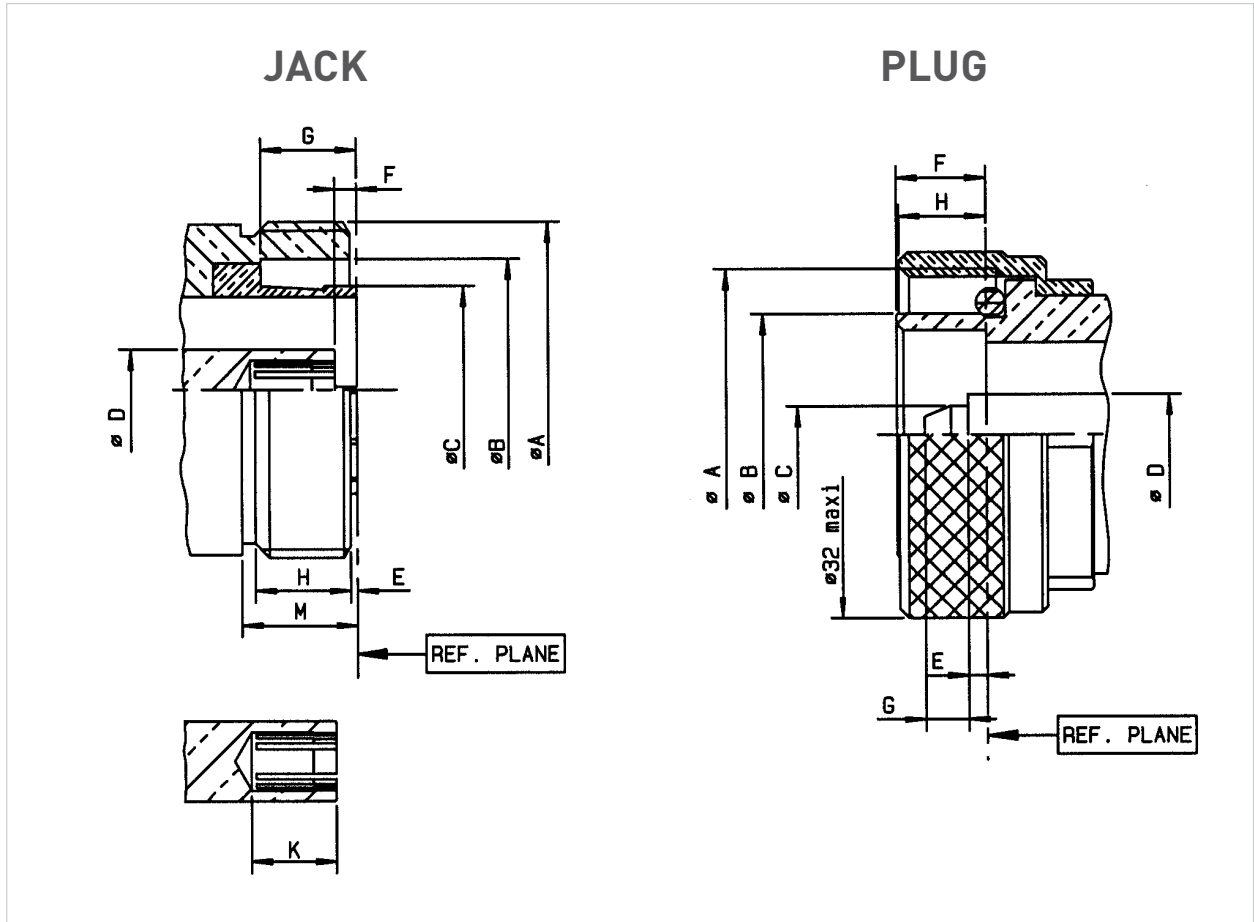

Letter	mm		inch	
	min.	max.	min.	max.
A DIA	M29 X 1.5		M29 X 1.5	
B DIA	22.5	22.7	.885	.893
C DIA	17.9	17.96	.704	.707
D DIA	6.95	7.00	.273	.275
E	0.50	0.70	.019	.027
F	1.77	2.07	.069	.081
G	8.20	8.40	.322	.330
H	8.25	8.75	.324	.344
K	7.25	7.55	.285	.297

Letter	mm		inch	
	min.	max.	min.	max.
A DIA	M29 X 1.5		M29 X 1.5	
B DIA	20.8	21.0	.818	.826
C DIA	4.97	5.03	.195	.198
D DIA	6.95	7.00	.273	.275
E	1.47	1.77	.057	.069
F	7.40	7.80	.291	.307
G	3.60	4.00	.141	.157
H	7.30	7.80	.287	.307

## Characteristics

Test / Characteristics	Standard reference	Values / Remarks			
<b>ELECTRICAL CHARACTERISTICS</b>					
Impedance	-	50Ω			
Frequency range	-	DC - 7.5 GHz			
Typical V.S.W.R.	-	1 GHz	2.5 GHz	5 GHz	7.5 GHz
• Straight models	-	1.10 max from DC to 3 GHz - 1.20 max from 3 to 7.5 GHz			
RG213-RG214-RG393	-	1.04	1.06	1.08	1.10
.141"	-	1.04	1.07	1.08	1.20
.250"	-	1.03	1.05	1.11	1.13
1/2" superflexible corrugated	-	1.02	1.04	1.05	1.05
3/8" superflexible corrugated	-	1.03	1.03	1.12	1.20
1/4" superflexible corrugated	-	1.01	1.02	1.09	1.17
• Right angle models	-	1.15 max from DC to 3 GHz			
RG213-RG214-RG393	-	1.02	1.04	1.12	1.50
1/2" superflexible corrugated	-	1.04	1.04	1.14	1.60
3/8" superflexible corrugated	-	1.05	1.08	1.12	1.80
1/4" superflexible corrugated	-	1.02	1.06	1.13	1.60
Intermodulation product (IMP <sub>3</sub> )	-	-110 dBm typ. [- 153 dBc typ / 20 W]			
• Connectors	-	-125 dBm typ. [- 168 dBc typ. / 20 W]			
• Home made cable assemblies	-				
Insertion loss (dB)					
Straight connectors and right-angle connectors	MIL	0.05 vF (GHz)			
RF Leakage	CECC	130 dB at 1 GHz			
Insulation resistance	CECC	10 000 MΩ min			
Contact resistance					
• Center contact	CECC	< 0.4 mΩ			
• Outer contact		≤ 1.5 mΩ			
Working voltage in VRMS at sea level	CECC	2 700			
Dielectric withstanding voltage in VRMS					
• At sea level	CECC	4 000			
(at 70, 000 feet)		350			

## MECHANICAL CHARACTERISTICS

Durability	CECC	500 matings
Force to engage and disengage	CECC	15 N
Recommended coupling nut torque		
• Hex. coupling nut	-	3 500 Ncm (with torque wrench R 282 303 500)
• Hex. + cross knurl coupling nut	-	3 000 Ncm (with torque wrench R 282 303 520)
Proof torque	CECC	3 500 Ncm
Coupling nut retention force	CECC	1 000 N
Cable retention force		
Cable 5/50 & 10/50		250 N
Cable 1/4"	CECC	200 N
Cable 3/8"		250 N
Cable 1/2"		350 N
Cable 7/8"		500 N
Center contact retention force	CECC	200 N

## ENVIRONMENTAL CHARACTERISTICS

Temperature range		
• Flexible cables and corrugated cables	CECC	- 55 °C + 155 °C
• Semi-rigid cables		- 55 °C + 105 °C
Thermo cycling test	CECC	- 55 °C / + 155 °C / 56 days
Rapid change of temperature	IEC	- 55 °C / + 155 °C / 5 cycles
High temperature test	CECC	1000 hours / 155 °C
Corrosion salt spray	IEC	48 hours / Na Cl 5% / 35 °C
Vibration	CECC	98 m/s <sup>2</sup> - 10 Hz at 500 Hz
Moisture resistance		
• Clamp type	IEC 529	IP67
• Crimp type		IP65 (with heatshrink sleeve)
• Home made cable assemblies		IP68 (overmolding)
Hermetic test	IEC	5 Pa. cm <sup>3</sup> /s
Leakage	CECC	1 cm <sup>3</sup> /h max

## Characteristics

## MATERIALS AND PLATINGS

	Material	Plating
Bodies	Brass	Silver + BBR
Nut	Brass	BBR
Center contact • Male • Female	Brass Beryllium copper	Silver
Insulator	PTFE	-
Gasket	Silicon rubber	-

## POWER RANGE

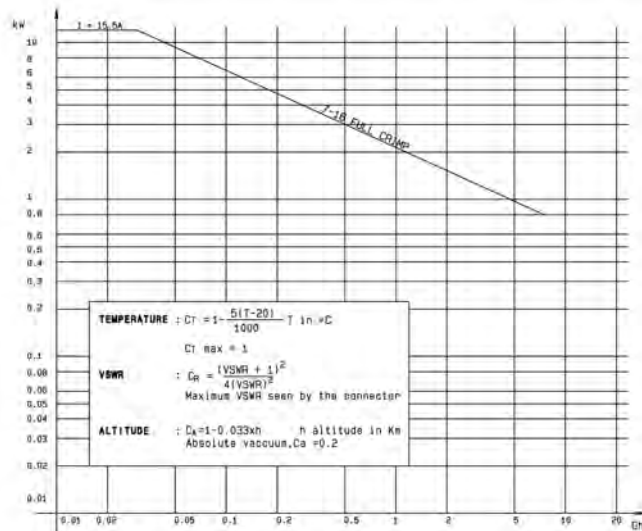

## Composite 7/16 Characteristics

## ELECTRICAL CHARACTERISTICS

Frequency range	DC - 7.5 GHz
VSWR	1.06@DC-3 GHz - 1.10@DC - 3-7.5 GHz
High working voltage	> 2700 V
Very low intermodulation	IMP3 < -125 dBm under 2 carriers of +43dBm And typically < -130 dBm
Power handling	> 800 W@ 935 MHz

## MECHANICAL CHARACTERISTICS

Longlife duration	up to 500 mating cycles
Coupling torque	35 Nm or less
Coupling strength	1000 N
Center contact retention / axial force	> 200 N
Center contact retention / torque	> 80 Ncm

## ENVIRONMENTAL CHARACTERISTICS

Temperature range	-40°C / +85°C
Humidity	Up to 100% @ 20°C
Flammability rating	UL94-V0
UV resistance	IEC 68-2-5 / IEC 68-2-9
Waterproof	IP67



Straight Plugs and Right Angle Plugs

STRAIGHT PLUGS, FOR FLEXIBLE AND SEMI-RIGID CABLE

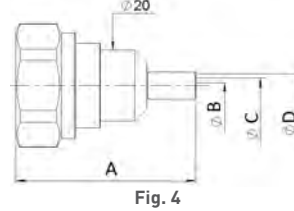
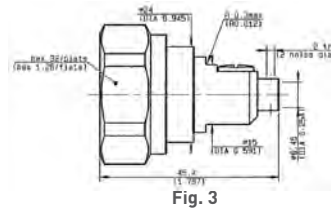
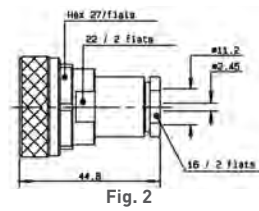
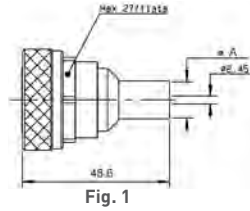

Cable group	Cable group dia.	Part number	Fig.	Dimensions (mm)				Captive center contact	Finish	Note
				A	B	C	D			
RG213 / RG393	10/50/S + D	R185 074 000	1	11.05	-	-	-	Yes	Silver + BBR	Crimp type
RG214	11/50/D	R185 077 000		11.4	-	-	-			Clamp type
RG213 / RG393 / RG214	10 + 11/50/S + D	R185 010 000	2	-	-	-	-	-	Silver + BBR	Solder type
RG401	.250"	R185 054 020	3	-	-	-	-	-	Silver + BBR	Solder type
AEP-240FR	LMR® 240	R185 083 310	4	51.15	1.5	4.05	6.6	Yes	BBR	Clamp type
AEP-400FR	LMR® 400	R185 085 007		49.55	2.82	7.46	11.05			
AEP-600FR	LMR® 600	R185 077 010		58.05	4.7	11.96	15.88			

RIGHT ANGLE PLUGS CRIMP AND CLAMP TYPE FOR FLEXIBLE CABLES

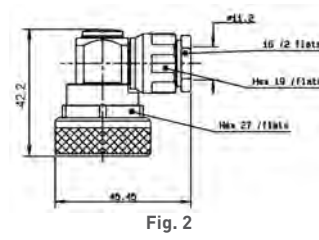
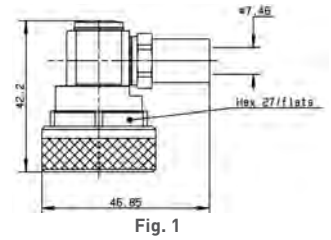

Cable group	Cable group dia.	Part number	Fig.	Captive center contact	Finish	Note
RG213	10/50/S	R185 174 000	1	Yes	Silver + BBR	Crimp type
RG214	11/50/D	R185 177 000				Clamp type
RG393 / RG214	10+11/50/D	R185 160 000	2	-	-	-

Straight Jacks and Square Flange Jacks

STRAIGHT JACKS

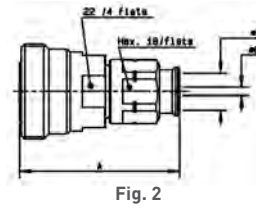
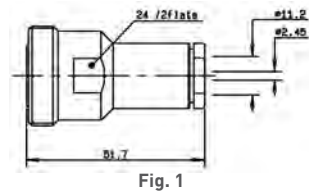

Cable group	Cable group dia.	Part number	Fig.	Dimensions (mm)			Captive center contact	Finish	Note
				A	B	C			
RG393 / RG214	10 + 11/50 D	R185 210 000	1	-	-	-	Yes	Silver + BBR	Clamp type
-	1/4" superflexible corrugated	R185 215 200	2	49.45	7.95	4.7			
-	1/2" superflexible corrugated	R185 216 200		50	14	8.8			
-	3/8" superflexible corrugated	R185 217 200		50	11	7.1			

STRAIGHT SQUARE FLANGE JACKS

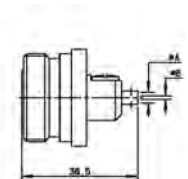
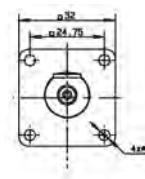
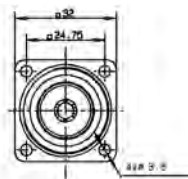
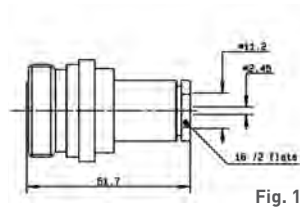

Cable group	Cable group dia.	Part number	Fig.	Captive center contact	Dimensions (mm)			Panel drilling	Finish	Note
					A	B	C			
RG393 / RG214	10 + 11/50 D	R185 260 000	1	Yes	-	-	-	P01	Silver + BBR	Clamp type for flexible cables
RG402	.141"	R185 252 000	2		3.65	0.996	3.6			Solder type for semi-rigid cables

Bulkhead Jacks and Receptacles

STRAIGHT BULKHEAD JACKS FOR FLEXIBLE CABLES AND CORRUGATED CABLES

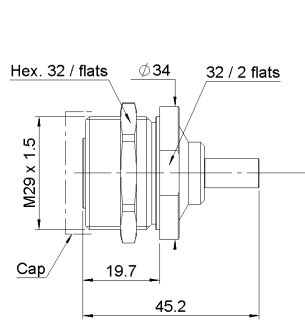

Fig. 1

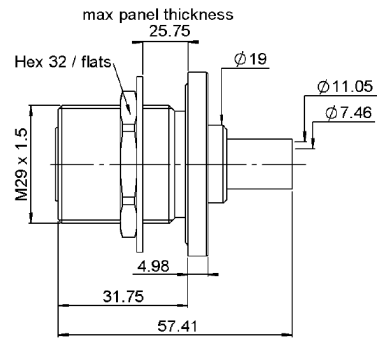

Fig. 2

Cable group	Cable group dia.	Part number	Fig.	Dimensions (mm)					Captive center contact	Panel drilling	Finish	Note
				A	B	C	D	E				
AEP-240FR	LMR® 240	R185 314 100	1	19.7	45.2	1.5	4.05	6.6				
AEP-400FR	LMR® 400	R185 320 020	2	31.75	57.41	7.46	11.05	25.75	Yes	P02	BBR	Clamp type

STRAIGHT FLANGE FEMALE RECEPTACLES

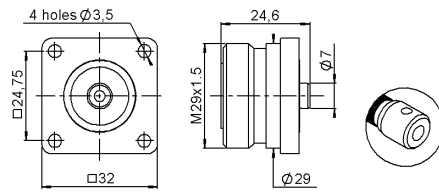
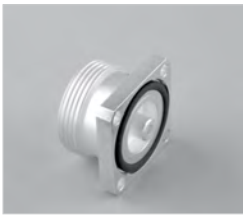

Fig. 1

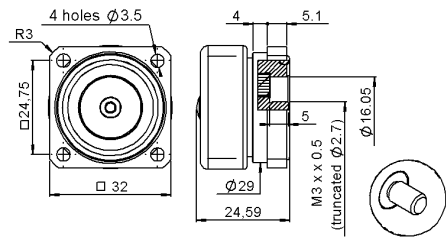

Fig. 2

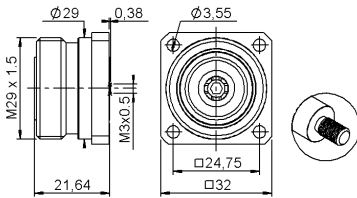

Fig. 3

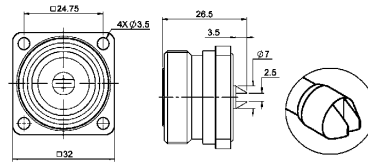

Fig. 4

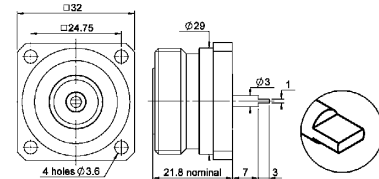

Fig. 5

Part number	Fig.	Captive center contact	Panel drilling	Finish	Slotted outer contact	Packaging	Note
R185 403 547	1	Yes	P03	BBR	No	20	With solder pot contact
R185 405 200	2		P05	Silver + Copper	Yes	-	Panel seal flange mount
R185 406 090	3		P05	BBR	No	50	M3
R185 404 200	4		P05	Silver + Copper		20	With slotted contact
R185 403 490	5		P04	Silver + Copper		20	With tab contact

In Series Adapters and Caps

IN SERIES ADAPTERS

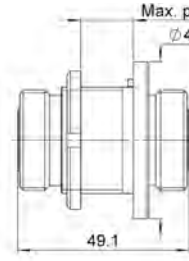
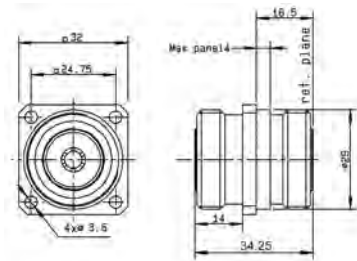
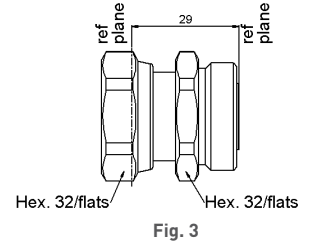
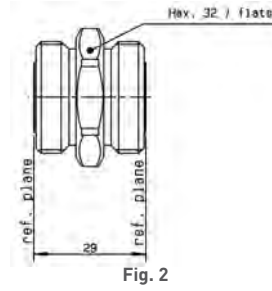
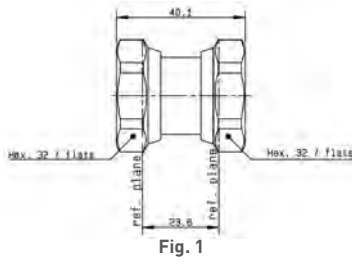
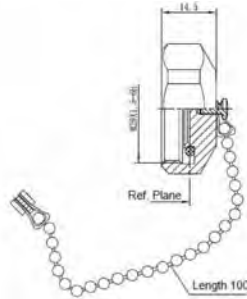

Fig. 4

Fig. 5

Part number	Fig.	Captive center contact	Panel drilling	Finish	Note
R185 703 000	1	Yes	-	Silver + Copper	Male - Male
R185 705 000	2		-		Female - Female
R185 707 000	3		-		Male - Female
R185 710 000	4		P01	Female - Female flange mount	
R185 730 020	5		P06	Silver + BBR	Female - Female

PROTECTIVE CAPS



Part Number	Note
R185 812 007	Male with chain

Square Flange Jacks

SQUARE FLANGE JACK RECEPTACLE SOLDER TYPE, PANEL SEAL

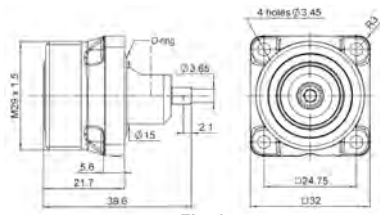

Fig. 1

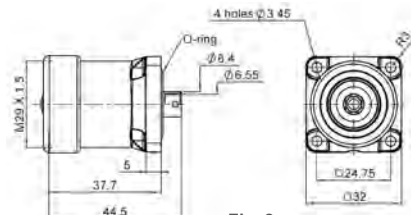

Fig. 2

Cable group	Cable group dia.	Part number	Fig.	Panel drilling
RG402	.141"	R187 403 010	1	P07
RG401	.250"	R187 130 000	2	

SQUARE FLANGE JACK RECEPTACLE PANEL SEAL

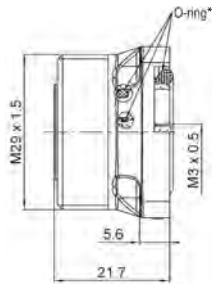

Fig. 1

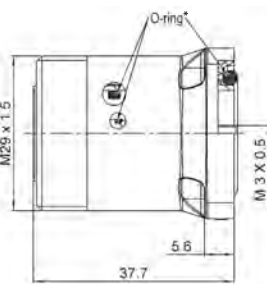

Fig. 2

Part number	Fig.	Captive center contact	Waterproof interface	Color	Panel drilling
R187 403 000	1	No	No	Black	P07
R187 403 100		No	Yes		
R187 406 000		Yes	No		
R187 406 100	2	Yes	Yes		
R187 413 000		No	No		
R187 413 100		No	Yes		
R187 416 000		Yes	No		
R187 416 100		Yes	Yes		

Available packaged in increments of 20 units  
 Processed according to customer needs  
 \* O-ring inside, only on the waterproof models

Panel Drilling

P01

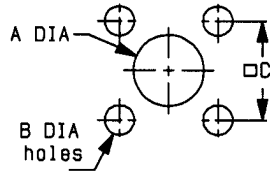

	MM		INCH	
	maxi	mini	maxi	mini
A	29.2	29.1	1.15	1.146
B	3.7	3.6	0.146	0.142
C	24.8	24.7	0.976	0.972

P02

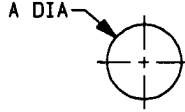

A	MM		INCH	
	maxi	mini	maxi	mini
	29.2	29.1	1.15	1.146

P03

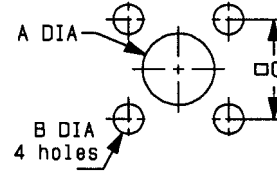

	MM		INCH	
	maxi	mini	maxi	mini
A (R. Mount)	16.2	16	0.638	0.63
A (F. Mount)	29.3	29.1	1.154	1.146
B	3.7	3.6	0.146	0.142
C	24.8	24.7	0.976	0.972

P04

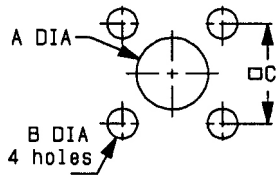

	MM		INCH	
	maxi	mini	maxi	mini
A	12.3	12.1	0.484	0.476
B	3.8	3.7	0.15	0.146
C	24.8	24.7	0.976	0.972

P05

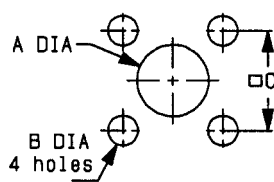

A	MM		INCH	
	maxi	mini	maxi	mini
	16.2	16	0.638	0.63
B	3.7	3.6	0.146	0.142
C	24.8	24.7	0.976	0.972

P06

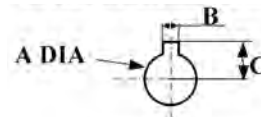

	mm	
	Maxi	mini
A	30.55	30.45
B	3.3	3.2
C	17.6	17.5

P07

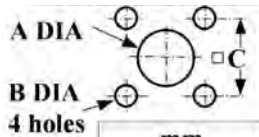

	mm	
	Maxi	mini
A	16.2	16
B	3.7	3.6
C	24.8	24.7

## Introduction



## Overview

Radiall has expanded its broad range of Quick Lock products with QLI (Quick Lock Low Intermodulation). With the QLI, Radiall introduces a new solution for harsh environments, where performance and safety are critical. QLI connectors are designed to provide performance similar to DIN 7/16 with a very low intermodulation level, and a quick and safe connection, without any tools. Compared to 7/16, QLI is cheaper but also smaller (-31%) and lighter (-62%) offering an easy to use concept with its bayonet coupling system.

QLI is double sealing and offers special anti-corrosion & watertight plating, which makes it the best choice for outdoor installations and also indoor applications where the high performance is required. QLI connectors are available in plugs, jacks, straight or right angle, square sockets & bulkhead models with a compact design allowing high density integration (saving time on field installation).

Its simple jack design makes QLI robust and easy to clean when equipment is subjected to severe conditions in the field.

## HIGH PERFORMANCE

- Impedance 50Ω
- Frequency range DC - 6 GHz
- Very low intermodulation level  $\leq -163\text{dBc}$
- Bayonet locking concept provides coupling retention force 450 N
- VSWR  $1.04 + 0.02 \sqrt{f}$
- Meets all requirements for IP67

50Ω

DC - 6 GHz

## GENERAL

- Quick Lock Low Intermodulation connector
- Bayonet coupling mechanism
- High power rating
- 31% smaller & 60% lighter than 7/16

## APPLICABLE STANDARDS

- IEC 61169
- MIL PRF 39012

## APPLICATIONS

- Telecom
- Medical
- Industrial
- Indoor and outdoor use



Step 1: Engage

Step 2: Push

Step 3: Lock

- High mating life
- 3 step connection: Engage, Push & Lock
- Intuitive design concept
- Light weight
- Reduced size allows more space for other components
- RF Power: Up to 1000 W @ 2 GHz

## Characteristics

Test / Characteristics	Values / Remarks
------------------------	------------------

**ELECTRICAL CHARACTERISTICS**

Impedance	50Ω
Frequency range	DC - 6 GHz
Typical VSWR	1.04 + 0.02 f (GHz)
Maximum insertion loss	0.05 √F (GHz) dB
Insulation resistance	5000 MΩ min
Voltage rating	<=1400 Veff
Dielectric withstanding voltage	>2500 Veff
Contact resistance	≤ 1 mΩ ≤ 1.5 mΩ
• Center contact	
• Outer contact	
Power	1000W @ 2 GHz
Intermodulation	>163dBc (>120 dBm) 2x20W
Typical RF Leakage	-100dB@1 GHz; -90dB@3 GHz; -80dB@5 GHz

**MECHANICAL CHARACTERISTICS**

Mechanical endurance	100 cycles
Engagement & disengagement force	<= 60N <= 50 N
• Engagement	
• Disengagement	
Mating mechanical retention force	450 N min.
Cable retention force	350 N mini with 1/2" S cable
Vibration	IEC 611169-1 10g / 10-500 Hz

**ENVIRONMENTAL CHARACTERISTICS**

Temperature range	- 55 °C ~ + 120 °C
Moisture resistance	IP67

**MATERIALS**

Connector bodies	Brass
Male center contact	Bronze / Brass
Female center contact	Bronze
Outer contact	Brass
Other metallic parts	Brass
Insulators	PTFE

**PLATING**

Bodies	BBR
Outer contact	BBR
Center contact	Silver



Plugs and Jacks

**STRAIGHT PLUGS**

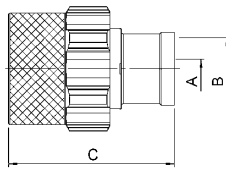

Fig. 1

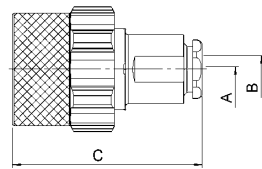
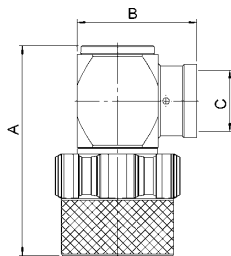

Fig. 2

Cable group	Cable group dia.	Part number	Fig.	Dimensions			Captive center contact	Finish	Packaging	Note
				A	B	C				
-	1/2" Superflexible corrugated	R184 061 007	1	3.8	12.55	29	Yes	Silver + BBR	50	Solder
-	1/4" Superflexible corrugated	R184 062 007		2	6.8	28.5				
RG58 / RG141 / KX15	5/50S	R184 082 007		1.05	5.41	40.15				
LMR®400 / LMR400® FR / AEP-400FR	10.3/50S	R184 086 007		2.82	11.05	39				
AEP-600F / LMR®600	15/50S	R184 087 007		4.7	15.88	42				
RG58 / RG141 / RG223 / RG400	5/50S+D	R184 006 007	2	1.05	5.6	38.5				Clamp
RG213 / RG214 / RG393	10+11/50S+D	R184 018 007		2.45	11.2	46.5				
-	1/2" Superflexible corrugated	R184 037 007		N/A	14	49.7				

**RIGHT ANGLE PLUGS**



Cable group dia.	Part number	Dimensions			Captive center contact	Finish	Packaging	Note
		A	B	C				
1/2" Superflexible corrugated	R184 191 007	42.7	24.40	12.55	Yes	Silver + BBR	50	Solder

**STRAIGHT JACK**

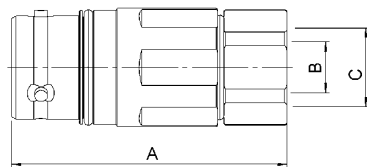

Cable group dia.	Part number	Dimensions			Captive center contact	Finish	Packaging	Note
		A	B	C				
1/2" Superflexible corrugated	R184 216 007	49.1	9.00	14.00	Yes	Silver + BBR	50	Clamp

Jacks and Cap

**BULKHEAD STRAIGHT JACK**

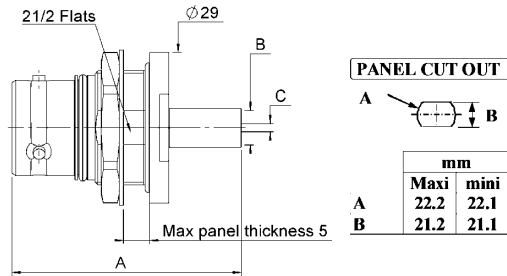

Cable group	Cable group dia.	Part number	Dimensions			Captive center contact	Finish	Packaging	Note
			A	B	C				
LMR®240 / AEP-240FR	6.1/50S	R184 335 007	44.2	6.60	1.50	Yes	Silver + BBR	50	Crimp
RG213 / RG214 / RG393	10+11/50S+D	R184 339 007	43.6	11.20	2.45				Clamp

**SQUARE FLANGE STRAIGHT JACK**

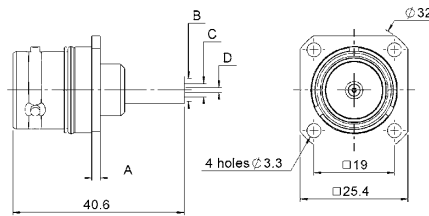

Fig. 1

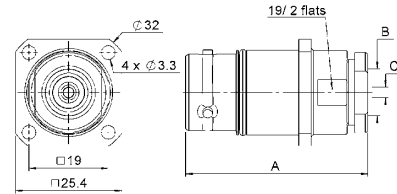

Fig. 2

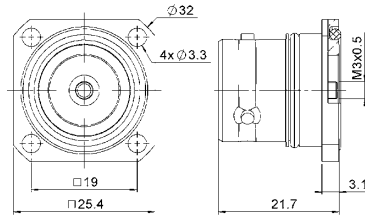
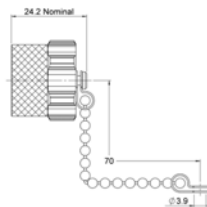

Fig. 3

Cable group	Cable group dia.	Part number	Fig	Dimensions				Captive center contact	Finish	Packaging	Note
				A	B	C	D				
RG58 / KX15 / RG141	5/50S	R184 282 007	1	41	5.41	3.11	1.05	Yes	Silver + BBR	50	Crimp
RG393 / RG214 / RG213	10+11/50S+D	R184 339 007	2	43.6	11.20	2.45	Clamp				
-	M3	R184 405 007	3	-	-	-	-				

**PROTECTIVE CAP**



Part number	Note
R184 960 007	Metallic male with chain - IP67

## Introduction



50Ω

DC - 6 GHz

### GENERAL

- Low Intermodulation connector
- Screw-on & Push-pull coupling mechanism
- High power rating
- 30% smaller & 60% lighter than 7/16

### APPLICABLE STANDARDS

- IEC 61169
- MIL PRF 39012

### APPLICATIONS

- Telecom
- Medical
- Industrial
- Indoor and outdoor use

## Overview

Designed for major telecom equipment manufacturers, the 4.3-10 series offers a small, lightweight solution for outdoor telecom applications where high performance is essential and low intermodulation is required.

Radiall's broad product portfolio includes the 4.3-10, 4.1-9.5, 7/16 and the innovative QLI (Quick Lock Low Intermodulation) connector. These solutions are suitable for harsh environments where reliability is required.

Available in a variety of configurations including:

- Jack/Bulkhead
- Square flange receptacles and plugs
- Right angle models
- Solder, crimp and clamp models
- Screw-on and push-pull coupling mechanism

4.3-10 connectors are 30% smaller and 60% lighter than comparable 7/16 square flange jack receptacles. The new interface features a high intermodulation level ranging from 0-6 GHz and provides a low intermodulation level at  $<-166\text{dBc}$ .

Radiall's 4.3-10 connector solution is designed in accordance with international standards and manufactured to meet environmental safety requirements.

### HIGH PERFORMANCE

- Impedance 50Ω
- Frequency range DC ~ 6 GHz
- Very low intermodulation level  $\leq -166\text{dBc}$
- Screw-on and Push-pull coupling mechanism for safety and easy to use
- VSWR 1.04 + 0.01 vf
- Meets all requirements for IP67
- High mating life
- 3 step connection: Engage, Push & Lock
- Intuitive design concept
- Light weight
- Reduced size allows more space for other components
- RF Power: Up to 500 W @ 2 GHz

## Characteristics

Test / Characteristics	Values / Remarks
------------------------	------------------

**ELECTRICAL CHARACTERISTICS**

Impedance	50Ω
Frequency range	DC - 6 GHz
Typical VSWR	1.04 + 0.01 f [GHz]
Maximum insertion loss	0.05 √f [GHz] dB
Insulation resistance	5000 MΩ min
Voltage rating	≤1000 Veff
Dielectric withstanding voltage	≥2500 Veff
Contact resistance	≤ 1 mΩ ≤ 1.5 mΩ
• Center contact	
• Outer contact	
Power	500W @ 2 GHz
Intermodulation	≤165dBc (>120 dBm) 2x20W
Typical RF Leakage	-110dB@3 GHz; -100dB@3-6 GHz

**MECHANICAL CHARACTERISTICS**

Mechanical endurance	100 cycles	
Mating force (push-pull version)	≤100 N ≤80 N	IEC 61169-1 §9.3.6
• Engagement force for mating		
• Separation force for mating		
Mating torque (tool screw type)	5 N. m	IEC 61169-1 §9.3.6
• Torque		
Mating mechanical retention force	450 N min.	
Cable retention force	350 N mini with 1/2" S cable	
Vibration	10g 2 Hz to 200 Hz	IEC 61169-1 § 9.3.3

**ENVIRONMENTAL CHARACTERISTICS**

Temperature range	- 55 °C ~ + 90 °C
Moisture resistance	IP67

**MATERIALS**

Connector bodies	Brass
Male center contact	Bronze / Brass
Female center contact	Bronze
Outer contact	Brass
Other metallic parts	Brass
Insulators	PTFE

**PLATING**

Bodies	BBR
Outer contact	BBR
Center contact	Silver

Plugs

**STRAIGHT PLUGS FOR FLEXIBLE AND SEMI-RIGID CABLES**

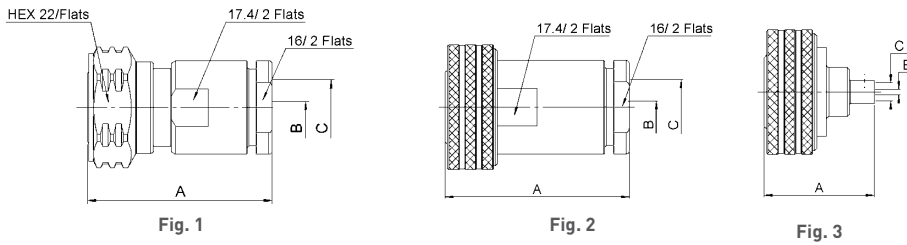

Cable group	Cable group dia.	Part number	Fig.	Dimensions			Captive center contact	Finish	Coupling mechanism	Note
				A	B	C				
RG213 / RG393 / RG214	10+11/50S+D	R183 010 017	1	37.5	2.45	11.20	Yes	Silver + BBR	Screw-on	Clamp
		R183 010 007	2						Push-pull	
RG402 / KS2	.141"	R183 052 007	3	21.9	0.96	3.7			Push-pull	Solder

**STRAIGHT PLUGS FOR CORRUGATED CABLES**

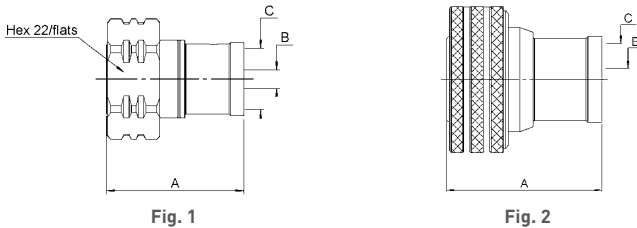

Cable group dia.	Part number	Fig.	Dimensions			Captive center contact	Finish	Coupling mechanism	Note
			A	B	C				
1/2" superflexible corrugated	R183 031 007	1	27.9	3.80	12.55	Yes	Silver + BBR	Screw-on	Solder
1/2" superflexible corrugated	R183 031 017	2						Push-pull	
1/4" superflexible corrugated	R183 030 017	1	23.8	2	6.8	Yes	Silver + BBR	Screw-on	Solder
1/4" superflexible corrugated	R183 030 007	2						Push-pull	
3/8" superflexible corrugated	R183 032 007	1	25.9	2.8	9.45			Screw-on	

**RIGHT ANGLE PLUGS FOR HANDFORMABLE AND SEMI-RIGID CABLES**

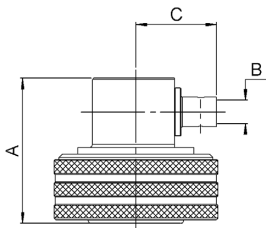

Cable group	Cable group dia.	Part number	Dimensions			Captive center contact	Finish	Coupling mechanism	Note
			A	B	C				
RG402 / KS2	.141"	R183 197 007	21.7	3.65	12.5	Yes	Silver + BBR	Push-pull	Solder

## Plugs and Jacks

### RIGHT ANGLE PLUGS FOR CORRUGATED CABLES

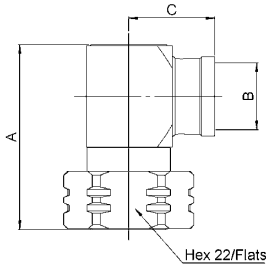

Cable group dia.	Part number	Dimensions			Captive center contact	Finish	Coupling mechanism	Note
		A	B	C				
1/2" superflexible corrugated	R183 165 007	34.7	12.55	16.15	Yes	Silver + BBR	Screw-on	Solder

### STRAIGHT SQUARE FLANGE JACKS

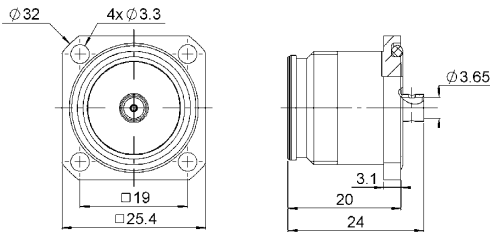

Cable group	Cable group dia.	Part number	Captive center contact	Panel drilling	Finish
RG402	.141	R183 252 007	Yes	P01	Silver / BBR

### SQUARE FLANGE JACK RECEPTACLES

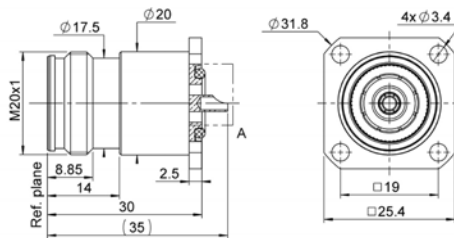

Part number	Captive center contact	Panel drilling	Finish	Note
R183 405 067	Yes	P01	Silver / BBR	Solder pot

### Connector Caps

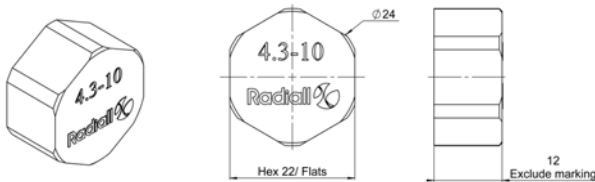

Part number	Note
R183 804 020	IP 67 for mated condition UV resistance

### Panel Drilling

P01

**PANEL CUT OUT**

	mm	
	Maxi	mini
A	7.46	7.3
B	3.6	3.5
C	19.05	18.95

## Introduction



50Ω

DC - 6 GHz

### GENERAL

- Screw-on coupling mechanism
- High power rating
- 20% smaller & 50% lighter than 7/16
- Low coupling torque
- Low intermodulation

### APPLICABLE STANDARDS

- IEC 61169
- MIL PRF 39012

### APPLICATIONS

- Telecom
- Medical
- Industrial
- Indoor and outdoor use

## Overview

Radiall completes its power connector range with 4.1-9.5, a low intermodulation series. 4.1-9.5 is designed to provide similar performance to 7/16 with smaller size and weight, using a proven screw-on coupling mechanism. With its corrosion resistance, Radiall 4.1-9.5 is the ideal choice for telecom applications where severe conditions require a high performance and robust connector.

### HIGH PERFORMANCE

- Impedance 50Ω
- Frequency range DC ~ 6 GHz
- Very low intermodulation level  $\leq -125$ dBc
- Screw-on coupling mechanism
- Coupling retention force 450 N
- VSWR 1.02 + 0.02 √f
- Meets all requirements for IP67
- High mating life
- Light weight
- Reduced size allows more space for other components
- RF Power: Up to 1000 W @ 1 GHz

## Characteristics

Test / Characteristics	Values / Remarks
------------------------	------------------

**ELECTRICAL CHARACTERISTICS**

Impedance	50Ω
Frequency range	0 - 6 GHz
Typical VSWR	1.02 + 0.02 F
Maximum insertion loss	0.05 √F (GHz)
Insulation resistance	5000 MΩ min
Voltage rating	<=1400 Veff
Dielectric withstanding voltage	<2500 Veff
Contact resistance	≤ 1.5 mΩ
Power	1KW @ 1 GHz
Intermodulation	-160 dBc

**MECHANICAL CHARACTERISTICS**

Mechanical endurance	100 cycles
Disengagement force	<12 N
Mating torque	1000 N.cm

**ENVIRONMENTAL CHARACTERISTICS**

Temperature range	- 55 °C ~ + 155 °C
Sealing	IP67

**MATERIALS**

Connector bodies	Brass
Male center contact	Brass
Female center contact	Beryllium Copper / Bronze
Other metallic parts	Brass
Insulators	PTFE

**PLATING**

Bodies	BBR2
Outer contact	BBR2
Center contact	Silver



Plugs and Jacks

**STRAIGHT PLUGS**

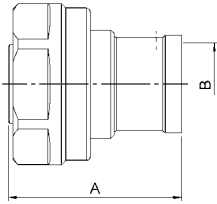

Fig. 1

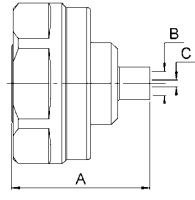

Fig. 2

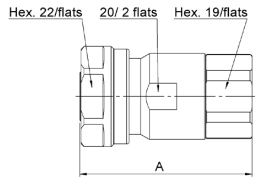
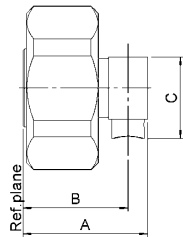
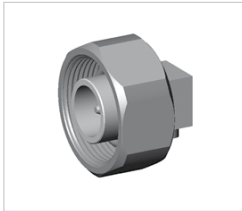

Fig. 3

Cable group dia.	Part number	Fig.	Dimensions			Captive center contact	Finish	Packaging	Note
			A	B	C				
1/2" superflexible corrugated	R170 031 107	1	31.7	12.60	-	Yes	Silver / BBR	50	Solder type
Hand formable cable .141"	R170 031 007	2	22	3.65	1.05				Clamp type
1/2" superflexible corrugated	R170 031 207	3	42	-	-				

**RIGHT ANGLE PLUG**



Cable group	Cable group dia.	Part number	Dimensions			Captive center contact	Finish	Packaging
			A	B	C			
RG402	Hand formable cable .141"	R170 152 107	19	16.00	12.50	Yes	Silver / BBR	50

**SQUARE FLANGE STRAIGHT JACK**

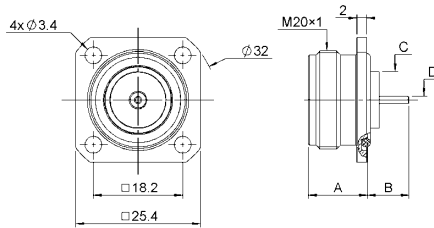

Part number	Dimensions				Captive center contact	Finish	Packaging
	A	B	C	D			
R170 413 127	12	8.50	11.50	1.50	Yes	Silver / BBR	50

# NOTE





## MISCELLANEOUS: BR2/TYPE 43/UHF/IMP/UMP

*R605/R214/R155/R107*

**Contents****TYPE 43**

Introduction.....	14-4
Interface .....	14-4
Characteristics .....	14-5
Panel drilling .....	14-8

**STANDARD DENSITY**

Plugs .....	14-6
Sockets.....	14-6
Receptacles.....	14-6

**HIGH DENSITY**

Plugs .....	14-7
U links.....	14-8

**ULTRA HIGH DENSITY**

Plugs .....	14-7
-------------	------

**IMP**

Introduction.....	14-9 to 14-10
Characteristics.....	14-11
Board to board connectors .....	14-12
Receptacle packaging.....	14-13
Assembly instructions .....	14-12

**UMP**

Characteristics.....	14-11
Receptacles.....	14-14
Pigtails .....	14-14
Cable assemblies.....	14-14
Tools and accessories.....	14-15
Assembly instructions .....	14-16

**BR2**

Interface .....	14-17
Characteristics.....	14-17
Plugs .....	14-18
Jacks .....	14-18
Receptacles.....	14-19
Caps .....	14-19
Gasket .....	14-20
Panel drilling .....	14-20

**UHF**

Interface .....	14-21
Characteristics.....	14-21
Plugs .....	14-22
Receptacles.....	14-22
Adapter.....	14-22

## Introduction



75Ω	DC - 3 GHz
-----	------------

### GENERAL

- Standard coaxial connectors
- Reliable lock coupling
- 3 types: Standard Density (12.7mm)  
High Density (10mm)  
Ultra High Density (9mm)

### APPLICABLE STANDARDS

- BS9210 F0022

### APPLICATIONS

- Telecom DDF (Digital Distribution Frames)

## Interface

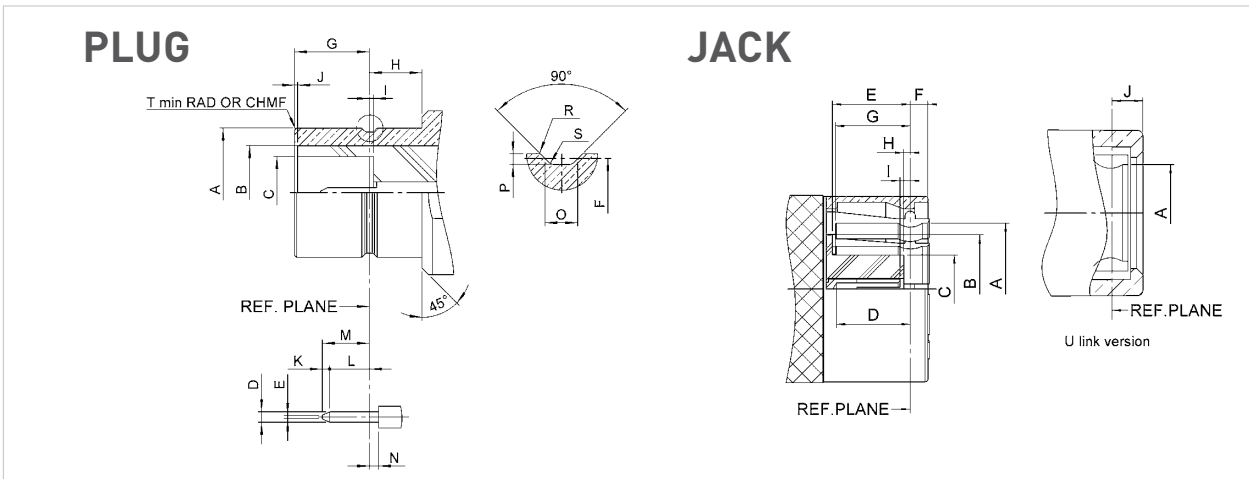

Letter	mm		inch	
	min.	max.	min.	max.
A DIA	6.20	6.23	.244	.245
B DIA	5.25 NOM		.207 NOM	
C DIA	3.4	3.475	.134	.137
D DIA	0.48	0.52	.019	.02
E DIA	0.125	0.225	.005	.009
F DIA	5.97	6.02	.235	.237
G	3.5	3.55	.138	.14
H	2.4	2.55	.095	.1
I	0.05	0.175	.002	.007
J	0.00	0.10	0.00	.004
K	0.25	0.35	.01	.014
L	1.35	-	.053	-
M	-	2.05	-	.081
N	-	0.18	-	.007
O	0.58 NOM		.023 NOM	
P	0.15	0.25	.006	.01
R	0.05	0.15	.002	.006
S	-	0.13	-	.005
T	0.1	0.2	.004	.008

Letter	mm		inch	
	min.	max.	min.	max.
A DIA	6.31	6.36	.248	.25
B DIA	5.25 NOM		.207 NOM	
C DIA	3.22	3.30	.127	.13
D	3.2	3.53	.126	.139
E	3.63	3.83	.143	.151
F	-	1.8	-	.071
G	3.61	3.77	.142	.148
H	0.23	0.38	.009	.015
I	0.23	0.48	.009	.019
J	1.475	1.97	.058	.078

## Characteristics

## TYPE 43 GENERAL TECHNICAL SPECIFICATION

Radiall 75Ω coaxial Type 43 connectors are designed to meet or exceed the requirements of BS9210 F0022. The following information is subject to change without notice. The performance values shown are typical and may not relate to all connector styles available.

Test / Characteristics	Values / Remarks
------------------------	------------------

## ELECTRICAL CHARACTERISTICS

Impedance	75Ω
Frequency range	DC - 3 GHz
Temperature range	-40°C to + 100°C
V.S.W.R. (Straight Connectors)	1.20 max
V.S.W.R. (Right Angle Connectors)	1.25 max
Voltage Rating	500 Vrms max
Dielectric Withstanding Voltage	1500 Vrms min
Insulation resistance	5000 MΩ min

## MECHANICAL CHARACTERISTICS

Durability	250 matings
Cable retention (Plug connectors) (Socket connectors)	60 to 220 N min***
Center contact retention (Plug connectors) (Socket connectors)	22 N min
Weight	10 g (grams) typical

## MATERIALS AND PLATING

Components	Materials	Platings
Body Components*	Brass	Selective Gold
Outer contact	Bronze	Selective Gold
Center contact (male)	Brass	Gold
Center contact (female)	Beryllium Copper	Gold
Insulator	PTFE	N/A
Panel Grommet	Polyacetal	N/A
Ferrule	Brass	Nickel
Panel Mounting Hardware**	Brass or Phosphor Bronze	Nickel

\* In general all Type 43 series connector bodies are gold plated in mating areas.

As a note, the single piece Type 43 connector body is gold plated in the mating area with other surfaces being nickel coated. All multi-piece connector bodies comprise of a gold plated front body (mating area) and a nickel plated back body (crimp area).

\*\* Panel mounting hardware includes components such as - nut, washer, spacer etc.

\*\*\* Note, **lower cable retention value** for RG179 - 60 N min and BT3002/TZC 75024 - 150 N min

Plugs, Sockets and Receptacles - Standard Density

**STRAIGHT SOCKETS CRIMP TYPE FOR FLEXIBLE CABLES**

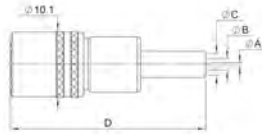

Cable group	Cable group dia.	BT Reference	Part number	Dimensions				Packaging
				A	B	C	D	
BT3002	3.6/75/D	S 43/5 FS	R214 083 922	0.36		4.47	3.2	20 pieces

**STRAIGHT BULKHEAD RECEPTACLE WITH SOLDER POT**

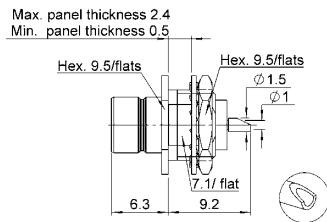

Part number	Panel drilling	Packaging
R214 553 000	P02	Unit

**STRAIGHT PCB PLUG RECEPTACLES**

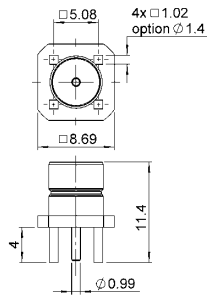

BT Reference	Part number	Panel drilling	Packaging
P 43 / 1 D	R214 426 704	P01	100 pieces

Plugs - High Density, Sockets and Ultra High Density

**STRAIGHT PLUGS CRIMP TYPE FOR FLEXIBLE CABLES**

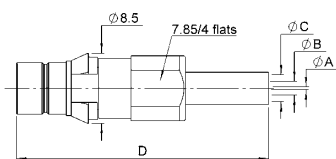

Cable group	Cable group dia.	BT Reference	Part number	Dimensions				Panel drilling	Packaging
				A	B	C	D		
RG179	2.6/75/S	HDC 43/4 GTIS	R214 318 702	0.38	1.73	3.25	35	P03	20 pieces
BT3002	3.6/75/D	HDC 43/5 GTIS	R214 318 722	0.36	2.10	4.47			
RA7000	4.5/75/D	HDC 43/7 GTIS	R214 325 742	0.69	3.00	5.48			

**STRAIGHT SOCKETS CRIMP TYPE FOR FLEXIBLE CABLES**

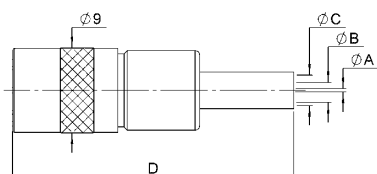

Cable group	Cable group dia.	BT Reference	Part number	Dimensions				Packaging
				A	B	C	D	
RG179	2.6/75/S	HDC 43/4FS	R214 088 902	0.38	1.73	3.25	32	20 pieces
BT3002	3.6/75/D	HDC 43/5FS	R214 088 922	0.35	2.10	4.47	30	

**STRAIGHT PLUG CRIMP TYPE FOR FLEXIBLE CABLES**

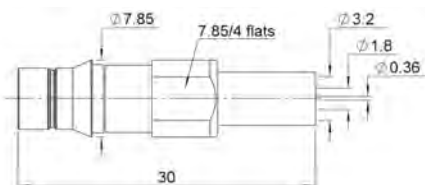

Fig. 1

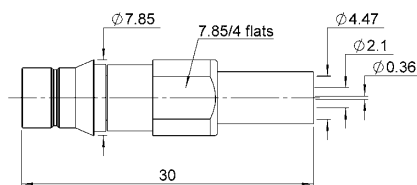

Fig. 2

Cable group	Cable group dia.	BT Reference	Part number	Fig.	Panel drilling	Packaging
RG179	2.6/75/S	UHDC 43/4 GTIS	R214 320 702	1	P04	20 pieces
BT3002	3.6/75/D	UHDC 43/5 GTIS	R214 320 722	2		



U Links - High Density

U LINKS

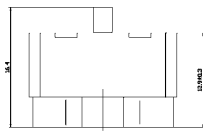

Fig. 1

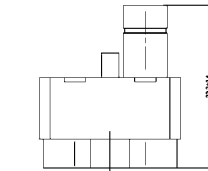

Fig. 2

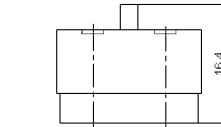

Fig. 3

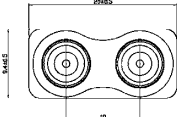

Fig. 4

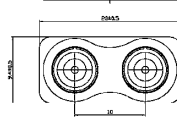

Fig. 5

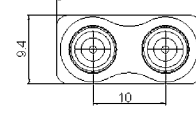
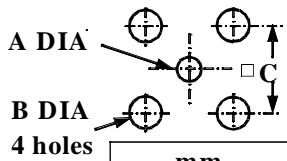

Fig. 6

BT Reference	Part number	Fig.	Packaging
U link 10A	R214 797 703	1	50 pieces
U link 10B	R214 798 703	2	
U link 13A	R214 790 703	3	
U link 13B	R214 791 703	4	
U link 9A	R214 797 723	5	
U link 9B	R214 798 723	6	

Panel Drilling

PO1



	mm	
	Maxi	mini
A	1.5	1.2
B	2.0	1.7
C	5.1	5.06

PO2

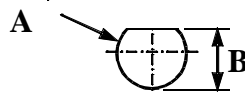

	mm	
	Maxi	mini
A	8.04	7.94
B	7.5	7.4

PO3

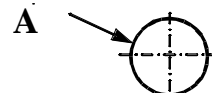

	mm	
	Maxi	mini
A	7.55	7.5

PO4



	mm	
	Maxi	mini
A	7.35	7.05

**Introduction**

Radiall introduced the MMP contact technology (Micro Miniature Pressure) in 2001 to meet the needs of the telecommunication industry for ultra low profile and cost effective board connectors. The MMP technology can be found in 2 product lines:

- **IMP** series: RF Board-to-Board application
- **UMP** series: RF board to wire application

**BOARD-TO-BOARD APPLICATION**



IMP

**BOARD TO WIRE APPLICATION**

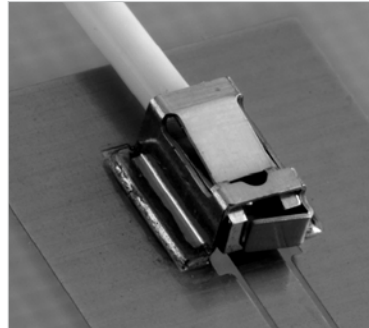

UMP

The **IMP** series (Interconnect Micro miniature Pressure contact) consists of 1 coaxial connector when usually the same application requires either 2 coaxial connectors (a male SMT receptacle and a female SMT receptacle), or 3 coaxial connectors (2 SMT receptacles and an adapter).

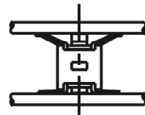

**IMP**  
One piece connector

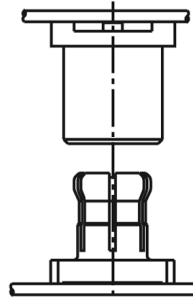

**MCX**  
2 coaxial connectors

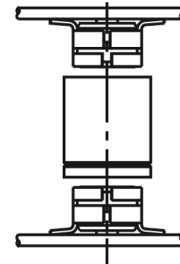

**MMS**  
3 coaxial connectors

The **UMP** series (Ultra Miniature Pressure contact) consists of 1 coaxial plug and 1 SMT edge receptacle.

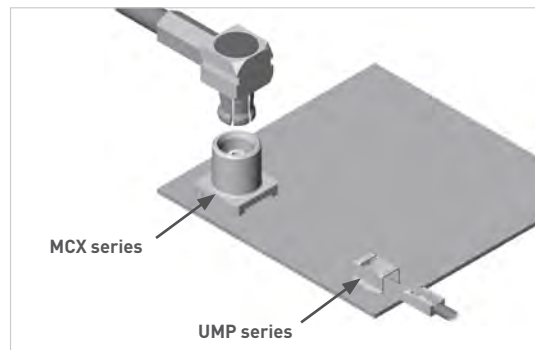

**Introduction****IMP PRODUCT FEATURES**

- Cost effective solution: one piece connector only
- High density
- Lightweight connector: (example 0.02 g for the IMP 2 mm)
- Low profile for a board-to-board coaxial connections (2 mm)

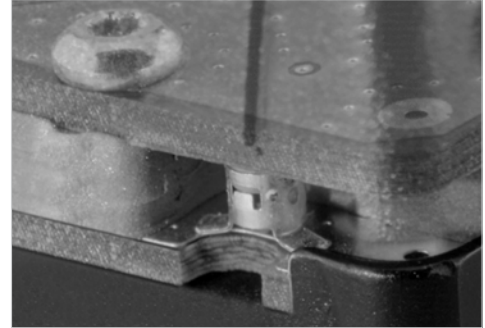
**IMP INSTALLATION**

The distance between the 2 boards should be precisely measured by a mechanical device (such as spacers).

Contact **Radiall** for support regarding the layout in your particular application. Application notes are available upon request.

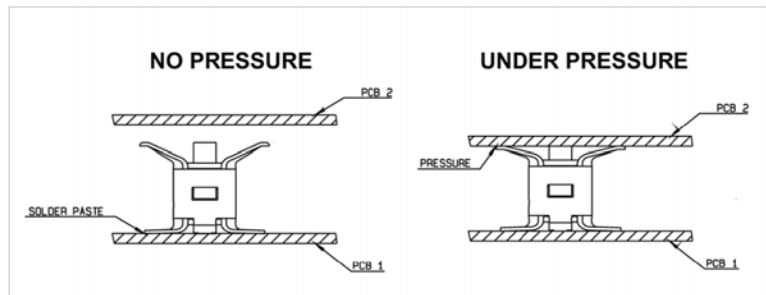
**IMP PRODUCT RANGE**

IMP is available in 2 mm board-to-board distance. Other heights can be developed upon request.

**UMP PRODUCT FEATURES**

- Low profile: 2 mm and 3 mm
- Small space for connection: needs only 2 mm of height
- Cost effective solution: 1 coax connector only
- Large cable range from 0.8 to 2.6 mm
- High durability, up to 10,000 cycles

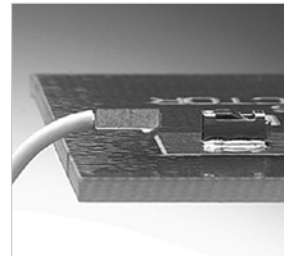
**UMP TYPE OF MATING:**

- Lock: - Can only be disconnected using a tool  
- Number of matings 100  
- Withstands severe vibrations
- Snap-on: - Number of matings 3000
- Snap-on: - Number of matings 10,000  
- For test applications

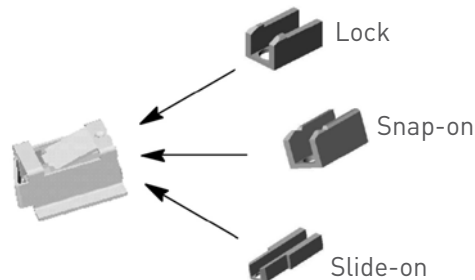

Plug exist with the 3 types of mating:

**APPLICATIONS**

IMP and UMP series can be used for board-to-board and board-to-antenna applications:

- WLAN
- Automotive
- RFID
- GPS receivers
- Handheld radios

## Characteristics

	Values / Remarks	
--	------------------	--

**ELECTRICAL CHARACTERISTICS**

	IMP	UMP
Impedance	50Ω	
Frequency range	DC-6 GHz	
V.S.W.R. Max	1.3	1.05 + 0.03F (mated connectors)
Insertion Loss (dB)	0.2 vF (GHz)	
RF Leakage	-40dB min at 2 GHz	
Insulation resistance	3000MΩ	1000MΩ min
Contact resistance (depending on PC board) • Center contact • Outer contact	60 mΩ 10 mΩ	
Working voltage	100 VRMS	
Dielectric withstanding voltage	350 VRMS	
Power at sea level, at 20°C	20 W (at 3 GHz)	50 W (at 1.8 GHz)

**MECHANICAL CHARACTERISTICS**

Durability	> 20	- Lock: 100 - Snap-on: 3000 - Slide-on: 10,000
Weight (g)	0.02	- Receptacle: 0.03 - Plug: 0.08
Axial misalignment from nominal board to board distance in mm (inch)	±0.2 (.008)	N/A
Radial misalignment in mm (inch)	0.2 (.008)	N/A
Force to engage	-	5N
Cable retention force	-	20N - 100N
Sine vibrations	-	IEC 68-2-6
Random vibrations	-	IEC 68-2-36
Shocks	-	IEC 68-2-29
Retention on test board	-	20N min

**ENVIRONMENTAL CHARACTERISTICS**

Temperature range	-40 / +90°C
-------------------	-------------

**MATERIALS**

Body/outer contact	Beryllium copper	-Plug: Brass -Receptacle: Beryllium copper
Center contact		Brass (plug only)
Insulator	Polyethercetone	PTFE

**PLATING**

Body	Gold
Contact	

Board-to-Board Connectors

SMT CONNECTORS

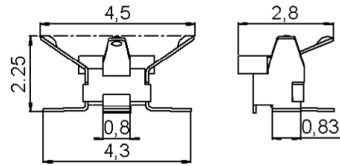

Part number	Height (mm)	Packaging	Reel dimensions A (mm)	Assembly instructions
R107 064 080	2	Reel of 3500	330	M01
R107 064 070		Reel of 100	180	

Assembly Instructions

M01

SOLDERING PATTERN

Part number  
R107 064 080

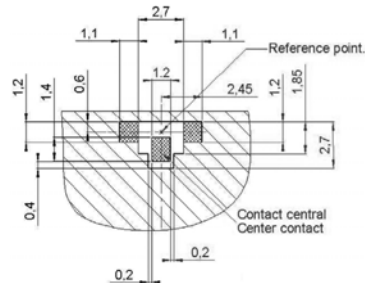

Part number  
R107 064 070  
R107 064 080

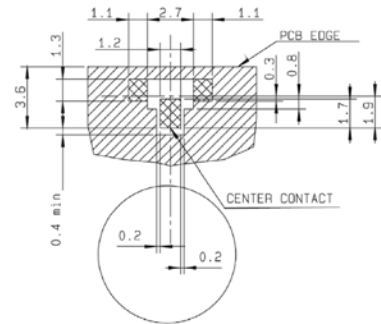

Metallization  
Land for solder paste (area free of varnish)

CONTACT PATTERN

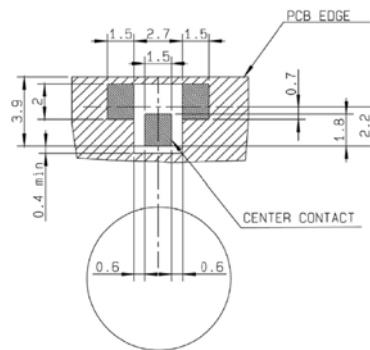
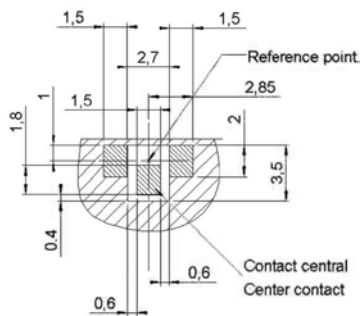

Metallization  
Contact area (area free of any surface contaminant)

## Receptacle Packaging

## PROCEDURE FOR USE OF SMT NOZZLE FOR RECEPTACLE

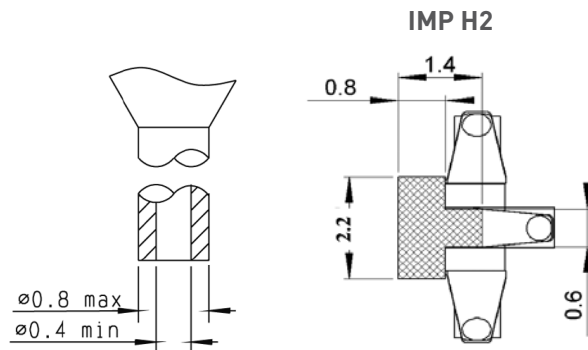

The following pick and place equipment and associated nozzles were successfully tested for the IMP:

- A) FUJI: QP-242/MODULE TYPE  
 QP-242 IMP MOUNT MODULE NAME: TYPE BI-612  
 IMP NOZZLE PART N°: I-S12B-013-100 (NOZZLE PIE 1.3)
- B) PANASONIC: MSF type machine  
 NOZZLE PART N°: 10 807 GH 810

For other equipment, please contact your supplier to define equivalent nozzles.

Receptacles, Pigtails and Cable Assemblies

SMT RECEPTACLES

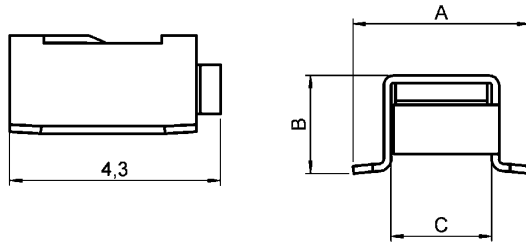

UMP type	Part number	Dimensions (mm)			Finish	Packaging	Reel dimensions (mm)	Assembly instructions
		A	B	C				
H2	R107 003 010	3.6	2	2.05	Gold	100 pieces	180	M02
H3	R107 303 040	5.5	3	2.95				

PIGTAILS

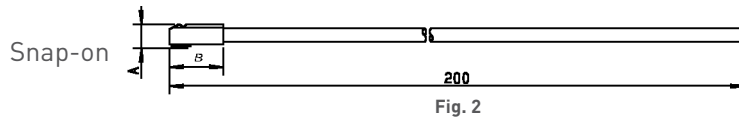
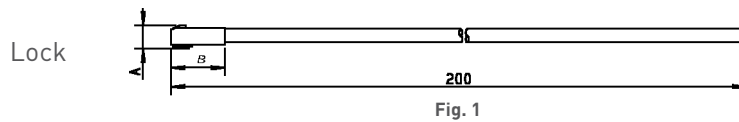

Cable	Cable group	UMP type	Mating type	Part number	Fig.	Dimensions (mm)		Packaging
						A	B	
C291 050 066	1/50/S	H2	Lock	R285 020 202	1	1.74	4	100 pieces
			Snap-on	R285 020 212	2			
C291 170 017	2.6/50/S	H3	Lock	R285 020 401	1	2.84		

BETWEEN SERIES CABLE ASSEMBLIES

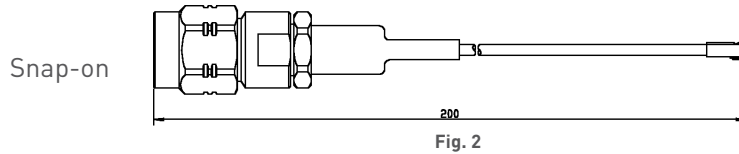
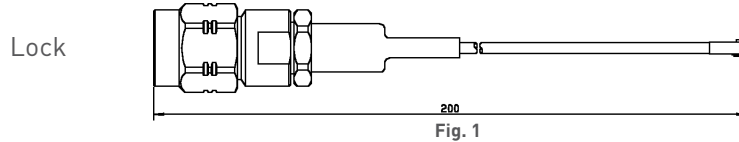

Cable	Cable group	UMP type	Mating type	Part number	Fig.	Series	Packaging
C291 050 066	1/50/S	H2	Lock	R285 025 202	1	UMP/SMA	20 pieces
			Snap-on	R285 025 212	2		
C291 170 017	2.6/50/S	H3	Lock	R285 025 401	1		

Tools and Accessories

**PRODUCTION LINE TEST ADAPTER: UMP - SMA FEMALE**  
(to be used with lock and snap pigtails only)

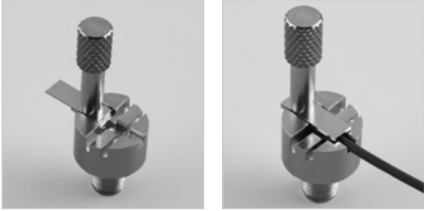

Part number	Connector height (mm)	Packaging
R107 009 901	H 2	Unit
R107 009 903	H 3	

For measurement and test purposes. Packaging: Unit

**EXTRACTION TOOL (for lock version only)**



Photo 1

Photo 2

Part number	Photo	Note	To disconnect	Packaging
R282 867 020	1	Axial disconnection	H 2	10 pieces
R282 867 030	2	Lateral disconnection	H 3	

The 2 disconnection tools allows axial and lateral disconnections depending on the occupied space on the PCB.

**INSERTION TOOL (optional)**



Part number
R282 203 020

This optional tool allows you a more precise connection in a limited space.

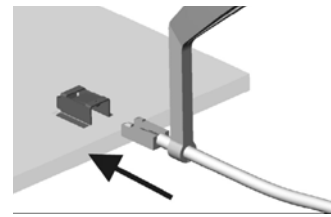

Packaging: Unit



Assembly Instructions

M02

RECEPTACLE SOLDERING PATTERNS FOR COPLANAR LINE

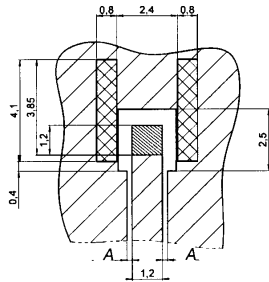

H2 type receptacle

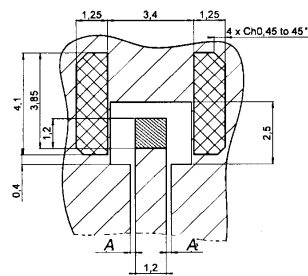

Part number
R107 003 010



H3 type receptacle

Part number
R107 303 040

PCB thickness (mm)	Coplanar ligne A (mm)
0.8	0.183
1.0	0.190
1.2	0.195
1.6	0.20

-  Gold over Nickel preferred for solder paste  
Gold can be replaced by tin lead (see test report SC2000.02.6587)
-  Gold over Nickel contact area free of any surface contaminant
-  Ground + varnish

SMT NOZZLE

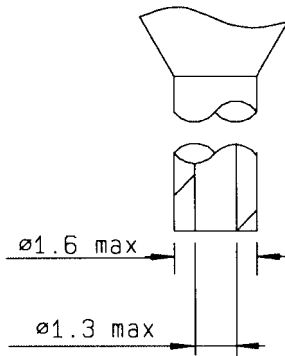

Automated pick and place machines use standard tooling to peel the antistatic film off. Sometimes the "A" dimension of this tool is shorter than the overall "B" width between the two legs of the receptacle. There is therefore a risk for the two legs being deformed while they pass through the tool during the suction operation. The user must then widen the "A" dimension of the peeling tool.

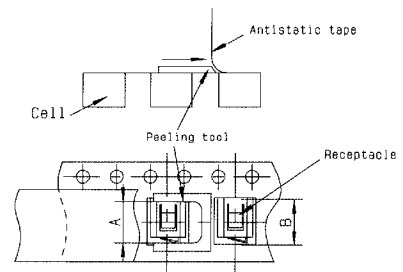

Interface

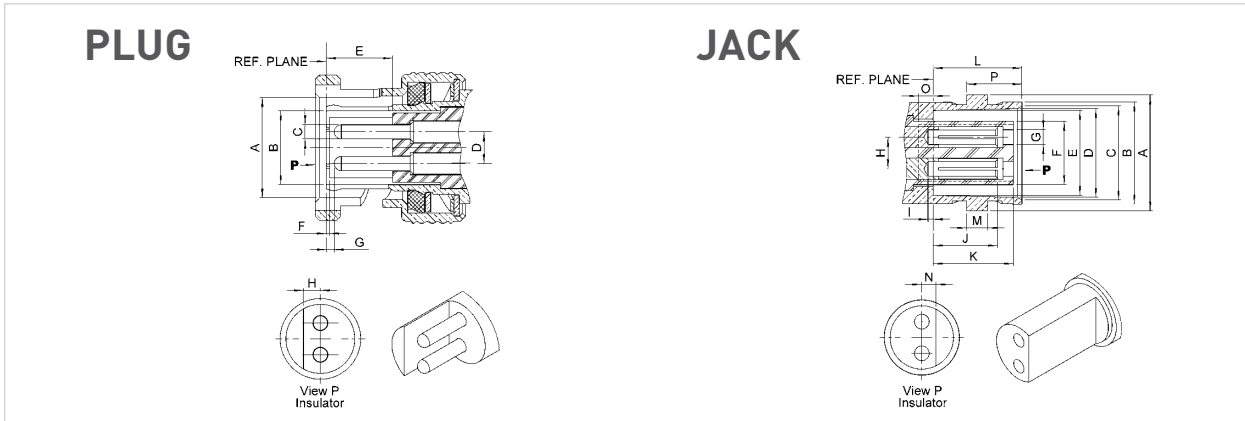

Letter	mm		inch	
	min.	max.	min.	max.
A DIA	9.78	9.91	.385	.390
B DIA	6.70	6.77	.264	.267
C DIA	1.31	1.36	.052	.054
D	2.95	3.05	.116	.120
E	7.6	7.9	.299	.311
F	-0.05	0.15	.002	.006
G	0.85	1.55	.033	.061
H	1.55	1.65	.061	.065

Letter	mm		inch	
	min.	max.	min.	max.
A DIA	10.93	11.09	.430	.437
B DIA	9.60	9.70	.378	.382
C DIA	8.79	9.04	.346	.356
D DIA	8.31	8.46	.327	.333
E DIA	8.09	8.15	.319	.321
F DIA	5.9	6.0	.232	.236
G DIA	1.4	1.45	.055	.057
H	2.95	3.05	.116	.120
I	-0.1	0.8	-.004	.031
J	5.3	5.7	.209	.224
K	7.05	7.35	.278	.289
L	8.36	8.46	.327	.335
M	1.91	2.06	.075	.081
N	1.45	1.55	.057	.061
O	0.35	0.85	.014	.033

Characteristics

Bayonet lock coupling with polarization

ELECTRICAL AND ENVIRONMENTAL CHARACTERISTICS

Dielectric withstanding voltage	Between pins Between pins and body	1.500 volts RMS, 50 Hz
Maximum intensity		3.5 Amp
Insulation resistance	Between pins Between pins and body	> 10 <sup>5</sup> MΩ
Contact resistance		< 1 mΩ at 1 Amp
Capacity at 1 MHz	Between pins Between pins and body	< 1.3 pF < 3.2 pF
Frequency range		DC - 0.5 GHz
Temperature range		-40 +100° C

MATERIALS

All metal parts under stress	Beryllium copper
Other metal parts	Brass
Insulators	Polyamide and diallyphtalate
Gaskets	Neoprene

Plugs and Jacks

**STRAIGHT PLUGS FOR ARMOUR TWINAXIAL CABLE**

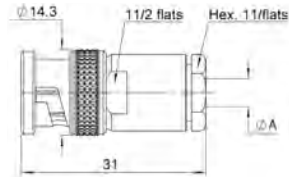

Cable group dia	Part number	Dimensions (mm) A
Twinaxial 4	R605 004 000	4.6
Twinaxial 5	R605 005 000	5.6
Twinaxial 6	R605 006 000	6.6

**RIGHT ANGLE PLUG**

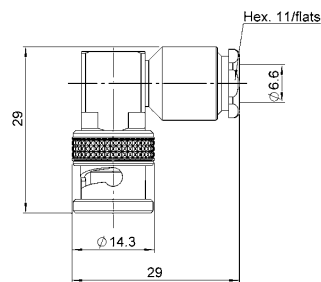

Cable group dia	Part number
Twinaxial 6	R605 156 000

**STRAIGHT JACKS**

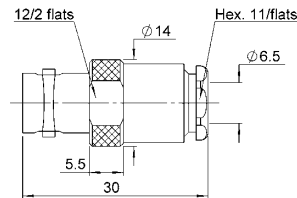

Fig. 1

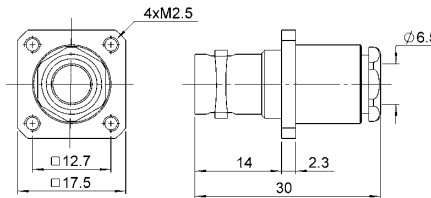

Fig. 2

Cable group dia	Part number	Fig.	Panel drilling	Note
Twinaxial 6	R605 206 000	1	P01	-
	R605 256 000	2		Square flange

Receptacles and Caps

RECEPTACLES

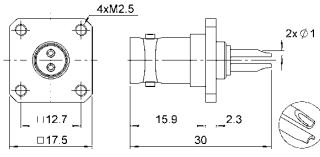

Fig. 1

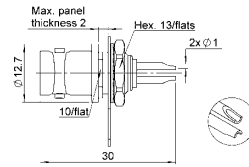

Fig. 2

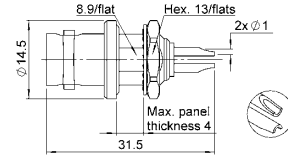
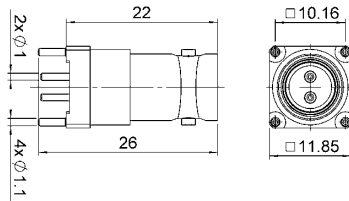
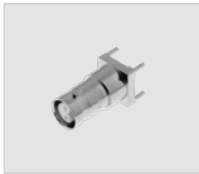

Fig. 3



Part number	Fig.	Panel drilling	Note
R605 400 000	1	P02	Square flange
R605 550 000	2	P04	Rear fixing
R605 550 020			Front mounting
R605 600 000	3	P05	Waterproof

PCB RECEPTACLES



Part number	Panel drilling
R605 440 000	P03

CAPS

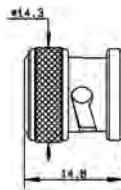

Fig. 1

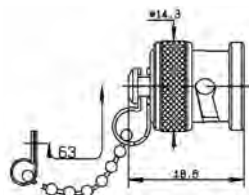

Fig. 2

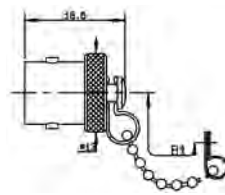

Fig. 3



Part number	Fig.	Note
R141 802 000	1	Male
R141 812 000	2	Male with chain
R141 842 000	3	Female with chain

Gasket

GASKET

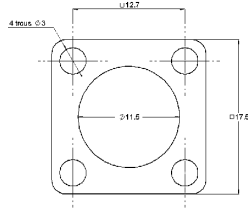

Part number
R280 503 000

Panel Drilling

PO1

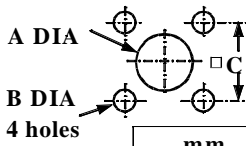

	mm	
	Maxi	mini
A (R. Mount)	11.3	11.2
A (F. Mount)	13	12.9
B	2.7	2.6
C	12.75	12.65

PO2

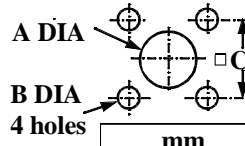

	mm	
	Maxi	mini
A	11.3	11.2
B	2.7	2.6
C	12.75	12.65

PO3

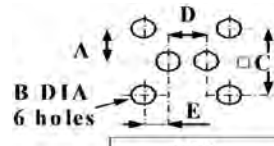

	mm	
	Maxi	mini
A	5.18	4.98
B	1.3	1.2
C	10.26	10.06
D	3.1	2.9
E	3.68	3.48

PO4

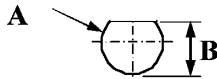

	mm	
	Maxi	mini
A	10.2	10.1
B	11.1	11

PO5

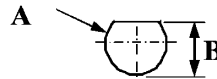

	mm	
	Maxi	mini
A	9.6	9.5
B	9.1	9

Interface

UHF

PLUG

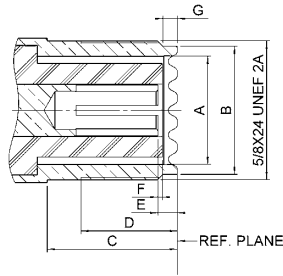

JACK

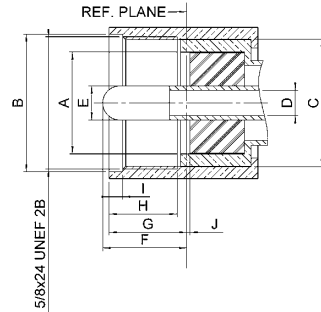

Letter	mm		inch	
	min.	max.	min.	max.
A DIA	11.56	12.22	.455	.481
B DIA	16.00	---	.630	---
C DIA	13.92	---	.548	---
D DIA	---	3.35	---	.132
E DIA	3.912	4.013	.154	.158
F	---	11.10	---	.437
G	---	9.91	---	.390
H	8.76	---	.335	---
I	1.19	4.27	.047	.168
J	0.00	---	.000	---

Letter	mm		inch	
	min.	max.	min.	max.
A DIA	11.56	12.22	.455	.481
B DIA	14.00	14.25	.551	.561
C	11.10	---	.437	---
D	7.87	---	.310	---
E	1.02	---	.040	---
F	0.03	---	.001	---
G	1.19	1.96	.047	.077

Characteristics

Test / Characteristics	Values / Remarks
------------------------	------------------

ELECTRICAL CHARACTERISTICS

Impedance	50Ω
Maximum frequency range	500 MHz
Test voltage (At sea level)	2000 V rms - 50 Hz
Working voltage (At sea level)	750 V
Insulation resistance (Under 500 V)	≤ 5 GΩ
Contact resistance • Centre contact • Outer contact	5 mΩ max 5 mΩ max

MECHANICAL CHARACTERISTICS

Mating cycles	500
---------------	-----

ENVIRONMENTAL CHARACTERISTICS

Temperature range • PTFE • Bakelite • Styramic	-55°C to + 155°C -40°C to + 165°C -40°C to + 70°C
Salt spray	48 Hrs

MATERIALS

Contacts and interfaces	Heat treated beryllium copper
Other parts	Brass
Insulator	PTFE (T) - bakelite (B) or styramic (St.)
Gaskets	Neoprene or silicone rubber

All dimensions are given in mm.

**STRAIGHT PLUGS**

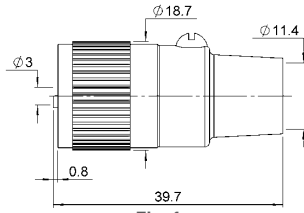

Fig. 1

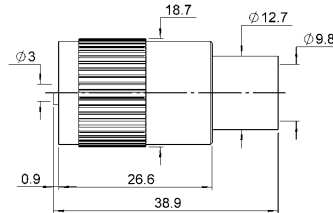

Fig. 2



Cable group	Cable group dia.	Part number	Fig.	Note
RG213 / RG393 / RG11 / RG12 / RG144	10/50+75Ω	R155 003 000	1	Insulator: PTFE
		R155 005 000	2	

**RECEPTACLES**

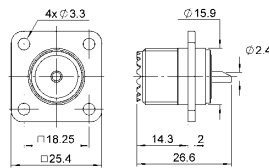

Fig. 1

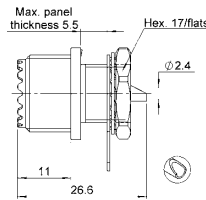
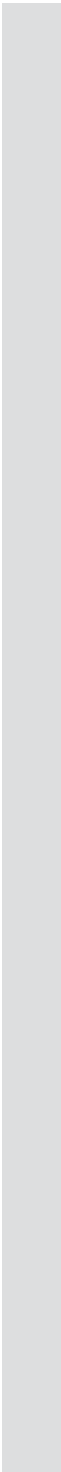

Fig. 2

Part number	Fig.	Panel drilling	Note
R155 405 000	1	P01	Square flange - Solder pot - Insulator: PTFE
R155 560 000	2	P02	Bulkhead - Solder pot - Insulator: PTFE

NOTE





# NOTE





## HIGH VOLTAGE CONNECTORS (BNC HT-MHV/SHV/THT 20/HN) NON-MAGNETIC CONNECTORS

*R316/R317/R331/R176*

**Contents**

<b>HN</b>	
Introduction .....	15-4
Interface .....	15-4
Characteristics .....	15-4
Plugs .....	15-5
Jacks .....	15-5
Receptacles .....	15-5
Adapters .....	15-6
Caps .....	15-6
Panel drilling .....	15-6
<b>HIGH VOLTAGE</b>	
Introduction.....	15-7 to 15-8
<b>BNC HT/MHV</b>	
Characteristics .....	15-7 to 15-8
Plugs .....	15-9
Jacks .....	15-9
Receptacles .....	15-9
Adapters .....	15-10
Gasket .....	15-10
<b>SHV</b>	
Characteristics .....	15-11
Plugs .....	15-12
Jacks .....	15-12
Receptacles .....	15-13
Adapter .....	15-13
<b>THT 20</b>	
Characteristics .....	15-14
Plugs .....	15-14
Receptacles .....	15-15
Panel drilling .....	15-15
<b>NON-MAGNETIC MCX</b>	
Introduction.....	15-16 to 15-19
MMCX Plugs .....	15-20 to 15-21
Plugs .....	15-20
Jacks .....	15-21
Receptacles.....	15-21
<b>NON-MAGNETIC SMP</b>	
Plugs .....	15-21 to 15-22
Receptacles.....	15-23
<b>NON-MAGNETIC SMB AND BNC</b>	
Plugs .....	15-21 to 15-22
Jacks .....	15-22
Receptacles.....	15-23
<b>NON-MAGNETIC CABLE TERMINALS</b>	
Right angle terminal .....	15-24
Straight terminal .....	15-23
<b>NON-MAGNETIC CABLE ASSEMBLIES</b>	
Non-magnetic cable assemblies.....	15-25
Panel drilling .....	15-25

## Introduction

The HN series is designed for industries needing accuracy in RF and HV applications up to 5000 Volts. Radiall continuously strives to improve the range of HN coaxial connectors for nuclear and harsh environments. Our customized connectors allow high radiation resistance, and by using a hexagonal nut for mating, they provide a secure connection. Please contact Radiall regarding this nuclear range.

## Interface

### PLUG

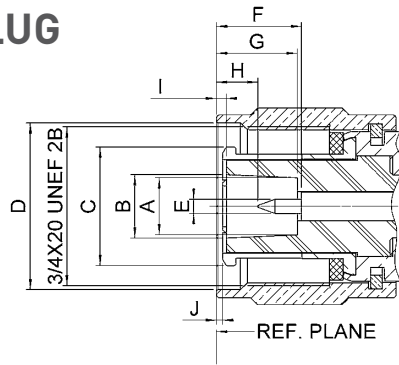

### JACK

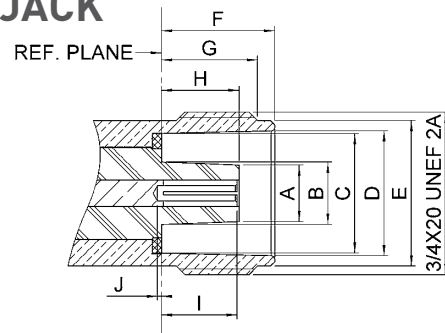

Letter	mm		inch	
	min.	max.	min.	max.
A DIA	6.7	6.8	.264	.268
B DIA	7.4	7.5	.291	.295
C DIA	13.85	13.95	.545	.549
D DIA	19.39	19.59	.763	.771
E DIA	1.62	1.66	.064	.065
F	9.3	10.1	.366	.398
G	9.2	9.7	.362	.382
H	3.9	5.3	.154	.209
I	0.15	0.55	.006	.022
J	-0.5	0.3	.020	.012

Letter	mm		inch	
	min.	max.	min.	max.
A DIA	6.55	6.65	.258	.262
B DIA	7.25	7.35	.285	.289
C DIA	13.91	14.01	.548	.552
D DIA	14.54	14.64	.572	.576
E DIA	16.91	17.01	.666	.670
F	13.2	13.25	.520	.522
G	11.1	11.35	.437	.447
H	8.75	9.25	.344	.364
I	8.55	9.15	.337	.360
J	-1.05	0.15	-.041	.006

## Characteristics

### ELECTRICAL CHARACTERISTICS

Frequency range	DC to 3 GHz
Impedance	50 Ω
Test voltage at sea level	5000 Vrms (except connector for 5/50-6/75 cable group & adapter M-F: 3000 Vrms)
Insulation resistance	5000 MΩ

### MECHANICAL CHARACTERISTICS

Mechanical endurance	500 matings
Vibration	20 g
Shock	1/2 sinusoidal (severity 100 A)

### ENVIRONMENTAL

Temperature range	-55°C + 155°C
Salt spray	48 Hrs
Panel sealing	Splashproof

### MATERIALS

Contacts and interfaces	Heat treated beryllium copper
Other pieces	Brass / Stainless steel
Insulator	PTFE / Ceramic / PEEK
Gasket	Silicone rubber

### PACKAGING

Packaging	Unit
-----------	------

Plugs, Jack and Receptacle

**STRAIGHT PLUGS CLAMP TYPE**

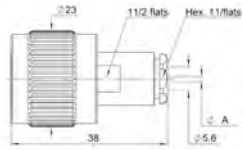

Fig. 1

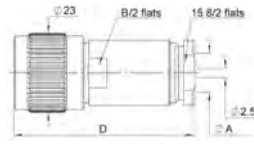

Fig. 2

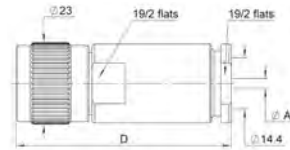

Fig. 3



Cable group	Cable group dia.	Part number	Fig.	Dimensions mm		
				A	B	D
RG58 / RG141 / RG142 / RG223 / RG400	5/50/S+D	R176 006 000	1	5.6	-	-
RG59 / RG62	6/75/S+93	R176 012 000		6.5	-	-
RG213 / RG393 / RG214	10+11/50/S+D	R176 018 000	2	11.2	17	49
		R176 019 000			15.8	56.5
		R176 021 000			17	53
RG 217	14/50	R176 027 000	3	2.5	-	63

**STRAIGHT JACK CLAMP TYPE**

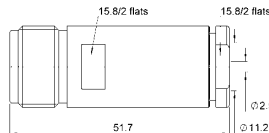

Fig. 1

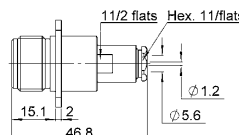
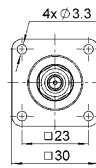

Fig. 2

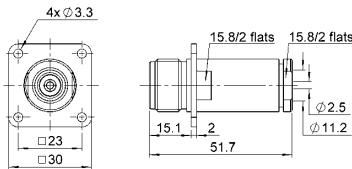
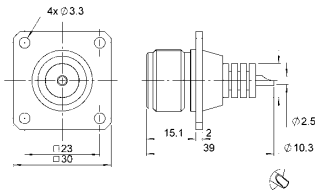

Fig. 3

Cable group	Cable group dia.	Part number	Fig.	Panel drilling	Note
RG213 / RG393 / RG214	10+11/50	R176 218 000	1	-	-
RG58 / RG141 / RG142 / RG223 / RG400	5/50/S+D	R176 256 000	2	P02	Square flange
RG213 / RG393 / RG214	10+11/50	R176 268 000	3		

**FLANGE RECEPTACLE**



Part number	Panel drilling	Note
R176 404 000	P02	Square flange - Solder pot

Adapters and Caps

IN SERIES ADAPTERS

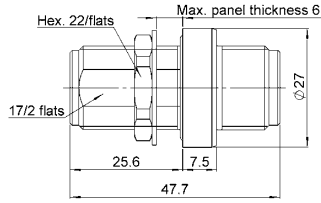

Fig. 1

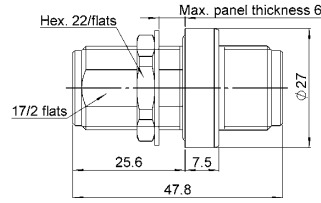

Fig. 2

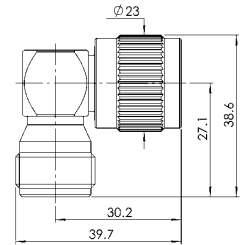

Fig. 3

Part number	Fig.	Panel drilling	Note
R176 754 000	1	P01	Bulkhead female - Female - Splashproof panel seal
R176 754 150	2		Bulkhead female - Female - Splashproof panel seal - Ceramic insulator
R176 770 000	3		Right angle - Male - Female

CAPS

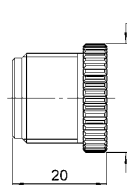

Fig. 1

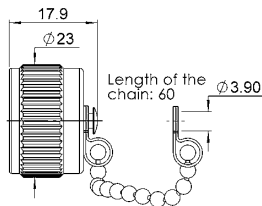
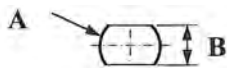

Fig. 2

Part number	Fig.	Note
R176 830 010	1	Protective cap
R176 811 000	2	Protective cap with chain

Panel Drilling

P01



	mm	
	Maxi	mini
A	19.3	19.2
B	17.3	17.2

P02

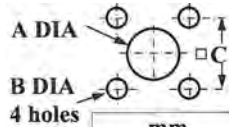

	mm	
	Maxi	mini
A	19.5	19.4
B	3.5	3.4
C	23.1	23

## Introduction

This catalog features 4 series of high voltage coaxial connectors - all able to withstand continuous voltage up to 20 000 V.

By redesigning the BNC HT interface in order to benefit from its high performance to serve MHV, Radiall created BNC HT/MHV. Radiall BNC HT/MHV is fully compatible with BNC HT with MHV interface according to MIL-STD-348.

## TEST VOLTAGES

The test voltages quoted in this catalogue are indicative only. They correspond to those made under normal atmospheric conditions during a test period of 1 minute as specified in the French standard NF EN 60068 - 1.

## OPERATING VOLTAGES

The operating voltage is chosen under the responsibility of users, depending on the conditions in which the connectors will be used (environment, safety factor...). The indicated cables are recommended for the mechanical and dimensional suitability with our connectors. As to the electrical characteristics of the cables and in particularly the maximum voltage capacity, it is necessary to conform with the recommendation of the cable manufacturer.

## Characteristics BNC HT/MHV

BNC HT/MHV connectors are not intermateable with the BNC and SHV series.

## ELECTRICAL CHARACTERISTICS

Frequency range	DC - 2 GHz
Impedance	50Ω
VSWR (plug and jack)	1.20 + 0.2 F (GHz)
Test voltage <ul style="list-style-type: none"> <li>• Unmated (Male)</li> <li>• Connectors (Female)</li> <li>• Mated pair</li> </ul>	6 000 V D.C.
	6 000 V D.C.
	10 000 V D.C.
Current rating	10 A

## MECHANICAL AND ENVIRONMENTAL CHARACTERISTICS

Mating cycles	500
Vibration	20 g - 2 000 Hz
Shock	50 g
Salt spray	48 H
Temperature range	- 55°C + 155°C - 40°C + 70°C (with polyethylene insulator)

## MATERIALS AND PLATING

Components	Material	Plating
Body	Brass	Nickel
Center contact	Brass / Beryllium copper	Silver
Other metal parts	Brass or Beryllium copper	Nickel
Insulator	PTFE / Polyethylene	-
Gasket	Silicone rubber	-

All dimensions are given in mm.

Plugs, Jacks and Receptacles

STRAIGHT PLUGS FOR FLEXIBLE CABLES

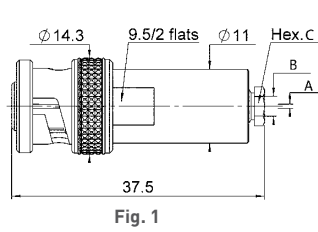

Fig. 1

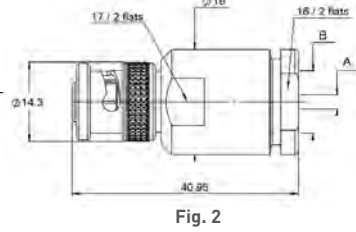

Fig. 2

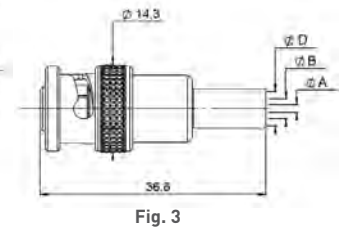

Fig. 3

Cable group	Cable group dia.	Part number	Fig.	Dimensions				Note
				A dia.	B dia.	Hex. C	D dia.	
RG174 / RG316 / RD316 / RG179 / RD179	2.6/50+75/S + D	R316 004 000	1	0.6	3	5/flats	-	Clamp type
RG58 / RG141 / RG142 / RG223 / RG400	5/50/S + D	R316 007 000		1.2	5.6	9.5/flats	-	
RG59/RG62	6/75/S	R316 011 000	3	1.2	6.5	9.5/flats	-	Crimp type
RG58/RG141	5/50/S	R316 072 000		1.2	3.2	-	5.6	
RG214 / RG393 / RG213	10/50/S+D	R316 020 010	2	2.5	11.2	-	-	Clamp type
RG59 / RG62	6/75/S	R316 072 010	3	1.2	4	-	6.6	

STRAIGHT JACKS CLAMP TYPE FOR FLEXIBLE CABLES

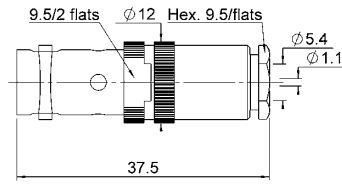

Fig. 1

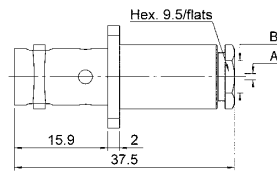

Fig. 2

Cable group	Cable group dia.	Part number	Fig.	Dimensions			Panel Drilling
				A	B	C	
RG58 / RG141 / RG142 / RG223 / RG400	5/50/S + D	R316 207 000	1	1.1	5.4	37.5	-
RG59 / RG62	6/75S	R316 211 000			6.5	38.5	-
RG58 / RG141 / RG142 / RG223 / RG400	5/50/S+D	R316 257 000	2	1.1	5.4	37.5	P01
RG59 / RG62	6/75/S	R316 261 000			6.5		



Receptacles, Adapters and Gasket

RECEPTACLES

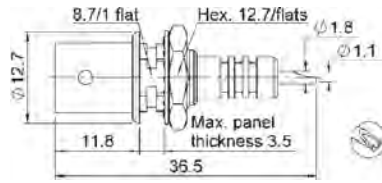

Fig. 1

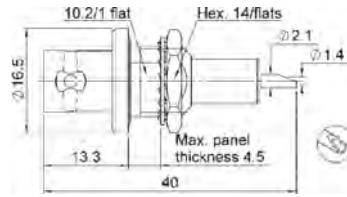

Fig. 2

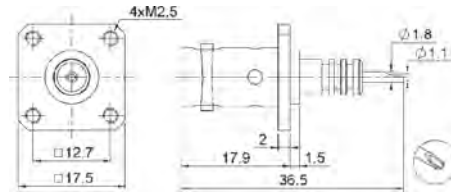

Fig. 3

Part number	Fig.	Panel Drilling	Note
R316 553 000	1	P02	Bulkhead
R316 603 000	2	P03	Bulkhead panel seal
R316 405 000	3	P01	Square flange mounting

IN SERIES ADAPTERS

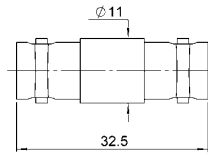

Fig. 1

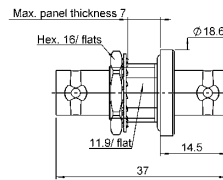
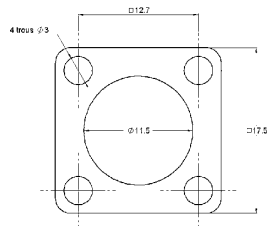

Fig. 2

Part number	Fig.	Panel Drilling	Note
R316 704 000	1	-	Straight female - Female
R316 754 000	2	P04	Straight bulkhead female - Female with panel seal

GASKET



Part number
R280 503 000

## Introduction

These safe high voltage connectors meet all requirements of the NIM Standard (Nuclear Instrumentation Module) Specification ND 545 Amendment A. Both the pin and socket contacts are securely recessed inside the insulation to guard against potential electrical shock when live unmated connectors are handled.

They are particularly recommended for impulse circuits of linear accelerators as well as in military, nuclear and medical electronics.

These connectors are not intermateable with the BNC and BNC HT/MHV series.

## Characteristics

### ELECTRICAL CHARACTERISTICS

Frequency range		DC - 2 GHz
Impedance		50Ω
VSWR (plug and jack)		< 1.20 + 0.3 F (GHz)
Contact resistance	• Center contact	< 2.1 mΩ
	• Outer contact	< 1.5 mΩ
Test voltage	• Unmated connectors	10 000 V D.C.
	• Mated pair	12 000 V D.C.
Current rating		10 A

### MECHANICAL AND ENVIRONMENTAL CHARACTERISTICS

Temperature range		- 65°C + 165°C
Mating cycles		500
Vibration		10 g - 500 Hz to MIL-STD-202, method 204, condition A
Shock		To MIL-STD-202, method 213 B, condition A
Salt spray		To MIL-STD-202, method 101, condition B-48 H
Contact to cable retention force		> 27 N
Coupling nut retention force		> 450 N
Cable retention		> 180 N

### MATERIALS AND PLATING

Components	Material	Plating
Body	Brass	Nickel
Center contact	Brass / Beryllium copper	Gold
Other metal part	Brass / Beryllium copper	Nickel
Insulator	PTFE	-
Gasket	Silicone rubber	-

Plugs

STRAIGHT PLUGS FOR FLEXIBLE CABLES

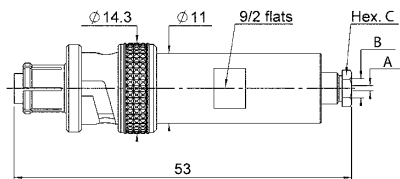

Fig. 1

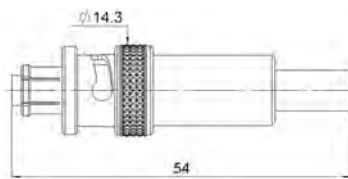

Fig. 2

Cable group	Cable group dia.	Part number	Fig.	Dimensions			Captive center contact	Note
				A dia.	B dia.	Hex. C		
RG58 / RG141 / RG142 RG223 / RG400	5/50/S + D	R317 005 000	1	1.05	5.6	9.5/flats	Yes	Clamp type
RG58 / RG141 RG59 / RG62	5/50/S 6/75/S	R317 072 000 R317 074 000	2	-	-	-		Crimp type

All dimensions are given in mm.

Jacks

STRAIGHT JACKS FOR FLEXIBLE CABLES

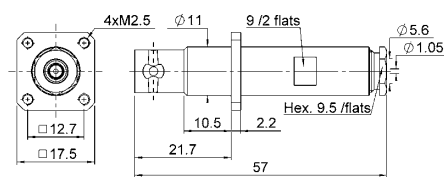

Fig. 1

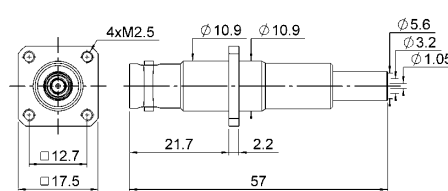

Fig. 2

Cable group	Cable group dia.	Part number	Fig.	Panel Drilling	Captive center contact	Note
RG58 / RG141 / RG142 RG223 / RG400	5/50/S + D	R317 255 000	1	P01	Yes	Square flange clamp type
RG58 / RG141	5/50/S	R317 270 000	2		-	Square flange crimp type

Receptacles and In Series Adapter

SHV

RECEPTACLES

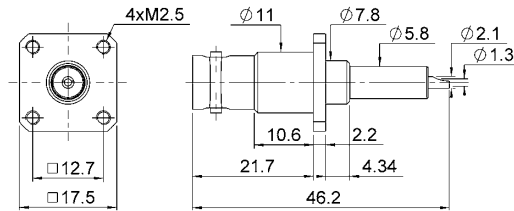

Fig. 1

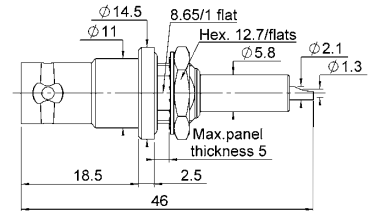
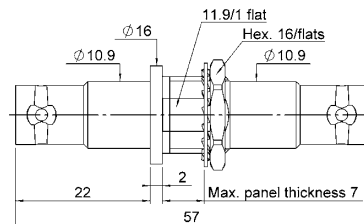

Fig. 2

Part number	Fig.	Panel Drilling	Note
R317 405 000	1	P05	Square flange
R317 580 000	2	P06	Bulkhead

IN SERIES ADAPTER



Part number	Panel Drilling	Note
R317 720 000	P04	Bulkhead jack - Jack

## Introduction

This large size screw-on interface has a 4 mm internal diameter female center contact which allows testing with standard banana plugs. THT 20 features the highest test voltage with a rating of 20 000 VDC for a mated pair.

## Characteristics

Female center contact has a 4 mm internal diameter which allows testing with standard banana plugs.

- Screw coupling

## ELECTRICAL CHARACTERISTICS

Frequency range		DC - 1 GHz
Impedance		50Ω
Test Voltage	• Unmated connectors	10 000 V D.C.
	• Mated pair	20 000 V D.C.
Current rating		20 A

## MECHANICAL AND ENVIRONMENTAL CHARACTERISTICS

Temperature range	- 40°C + 70°C (polyethylene or styramic insulators) -55°C + 125°C (PTFE insulator)
Mating cycles	500
Salt spray	48 H

## MATERIALS AND PLATING

Components	Materials	Plating
Body	Brass	Nickel
Center contact	Brass / Beryllium copper	Gold / Silver
Other metal part	Brass	Nickel
Insulator	PTFE / Polyethylene	-
Gasket	Silicone rubber	-

## Plugs

### STRAIGHT PLUGS, CLAMP TYPE FOR FLEXIBLE CABLES

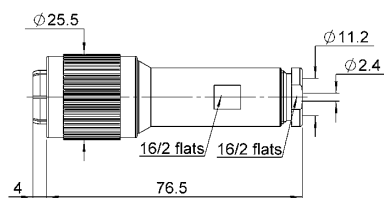

Fig. 1

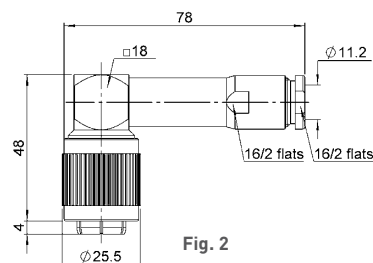

Fig. 2

Cable group	Cable group dia.	Part number	Fig.	Note
RG213 / RG393 / RG214	10/50+75/S + D + 11/50+75/D	R331 018 000	1	Straight / PE insulator
RG11 / RG12 / RG144 / RG216		R331 168 000	2	Right angle

Receptacles

RECEPTACLES

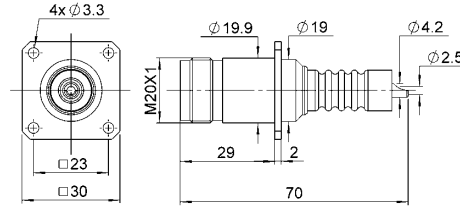

Fig. 1

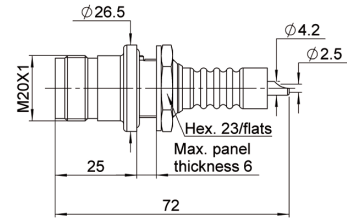
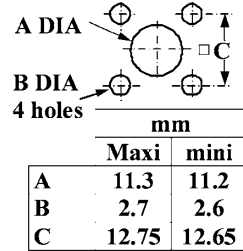

Fig. 2

Part number	Fig.	Panel drilling	Note
R331 405 000	1	P07	Square flange - PTFE insulator
R331 603 000	2	P10	Bulkhead, Panel seal PTFE insulator

Panel Drilling

P01



P02

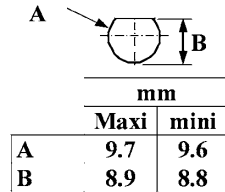

P03

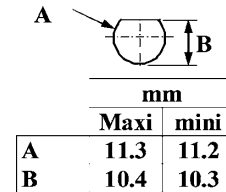

P04

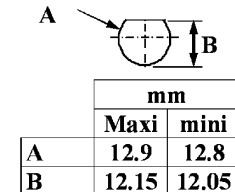

P05

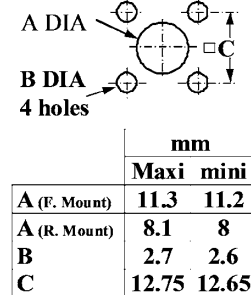

P06

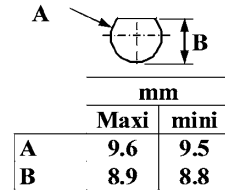

P07

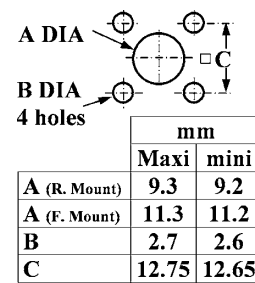

P08

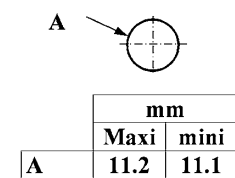

P09

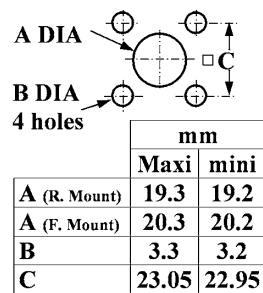

P10

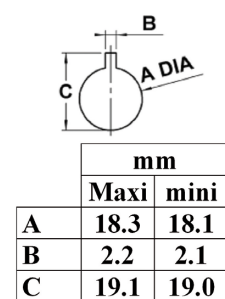

P11

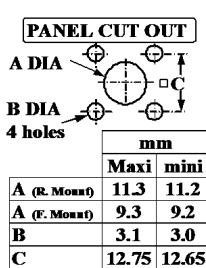

All dimensions are given in mm.

## Introduction

### Radiall: The Best Choice for Non-Magnetic Connectivity Solutions

At Radiall, we understand the market and are able to offer a range of non-magnetic RF connectors and cable assemblies for medical and space applications.

#### Why Radiall is Your Best Choice?

- **Collaboration:** We work closely with your engineers to understand your business, your technical needs, and your budget.
- **High Performance, Competitively Priced Products:** Our connectivity solutions give you the best combination of performance and value.
- **Wide Product Range:** We manage our product lines through the entire lifecycle, in order to offer you a wide selection of standard products at an affordable price.
- **Global Presence:** We offer worldwide sales, engineering support, R&D in North America, Europe, and Asia, and manufacturing facilities strategically located in the United States, Mexico, France, India, and China to provide on-demand cable assemblies.
- **Responsive Support and Service:** From the design stage, and planning to post-installation support, we're with you at every step, whether you need sales support or engineering expertise.
- **Warranty:** We stand behind our products.



#### Certifications and Environment

Radiall is ISO 9001:2008 certified and dedicated to continuous improvement programs that have resulted in AS9100, TS16949, and ISO 14001 certifications. In addition, Radiall is committed to investing in its people, future technologies, and the environment. Radiall is RoHS (Restriction of Hazardous Substances) and REACH (Registration, Evaluation, Authorization and Restriction of Chemical Substances) compliant.

#### The Best Manufacturing and Process Technologies

Our dedication to innovation and continuous improvement in leading-edge products means we excel in the techniques to create them:

- High precision machining: metal stamping, milling, turning, and cutting
- Molding, polishing
- Laser, ultrasonic, and vapor soldering
- Plating and plastic metallization
- Automatic assembly
- Characterization
- Test and measurement
- Cable and PTFE wrapping
- Thin and thick-film processes

## Introduction

### NON-MAGNETIC CONNECTOR FAMILIES

Radiall offers a growing range of non-magnetic connectors for medical, space, and other applications that includes MMCX, MCX, SMP, and SMB interfaces. To guarantee an exceptional non-magnetism level and repeatability, each non-magnetic connector is manufactured through a strictly controlled production process according to our quality assurance procedures.

For space applications, such as satellites used for scientific exploration, we offer an extensive range of SMA products, fully ESA qualified, meeting the residual magnetism required by the ESCC 3402 generic specification and the ESCC 3402/001, 002, and 003 detail specifications. Connectors are made of beryllium copper with gold plating and copper under-plating.

### NON-MAGNETIC MCX SERIES

Radiall has expanded the range of non-magnetic connectors with the MCX series. These connectors meet the need for smaller interconnections in space-limited MRI equipment, such as those for head, shoulder, or foot. With more reliable connections through superior performance, the reinforced connection system eliminates the risk of perturbation in image quality.

The non-magnetic MCX family also includes a new full-detent cable version, which has been tested in high-vibration conditions, that eliminates intermittent connections. It complies with MIL-STD-202, Method 204, Condition D for vibration testing.

Non-magnetic MCX connectors are available in a wide range of configurations for:

- Board-to-board connections
- Cable-to-board connections
- Cable-to-cable connections

### NON-MAGNETIC CABLE ASSEMBLIES

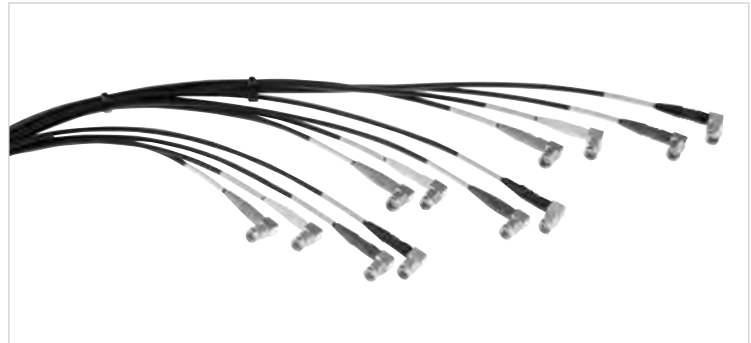
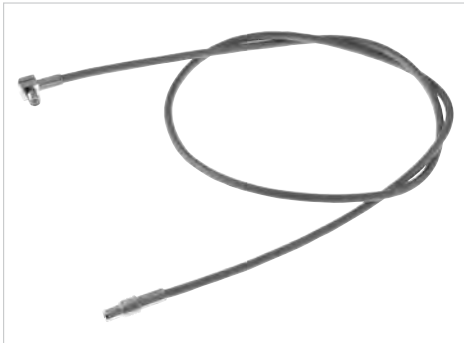

Radiall offers non-magnetic cable assemblies that provide a totally non-magnetic solution to reduce the risk of perturbation while working inside the  $B_0$  magnetic field. Non-magnetic cables are available in RG/316, RG/178 flexible or .085" and .141" semi-rigid styles.



## Introduction



### CUSTOM PRODUCTS

We are continually developing new non-magnetic products, including high-density, multiposition configurations.

**Multi-port connectors:** We offer a wide variety of solutions for high-density coaxial contacts based on the standard SMP, Coaxipack 2, SMB and SMA ranges with additional multiple DC contacts. Our expertise and extensive knowledge in RF coaxial connector and cable assembly technology allows us to offer superior technical project support including those projects that need new coaxial connections developed. Multi-port connectors offer the advantage of having only one connector instead of several separate connectors to mate and unmate.

### NON-MAGNETIC RF CONNECTORS FOR MEDICAL

Non-magnetic coaxial connectors are used primarily inside MRI and other medical imaging equipment. Magnetic resonance imaging produces high-resolution cross-sectional images of the inside of the human body by exploiting radio frequency (RF) pulses. MRI technology has seen tremendous improvements in recent years with continued advances in technology, a small part of which is due to coaxial non-magnetic connectors.

MRI medical equipment consists of a large magnet or electromagnet to create an intense and homogenous magnetic field (0.3 to 7 T) that surrounds the patient, "gradient coils" to position the area under analysis, and two high-frequency coils. One coil transmits RF pulses of 20 to 300 MHz to excite the atomic nucleus in the area under analysis. The other coil receives a signal that constitutes the image after excitation. The output is sent to a computer for processing and display.

The quality of the picture depends mainly on the homogeneity of the magnetic field and on the signal-to-noise ratio. To avoid any interference in the field homogeneity, coaxial connectors and cables located in the magnetic field to connect the coils should be transparent relative to the field, which means their relative permittivity  $\mu_r$  should be equal to 1.

High-quality non-magnetic connectors have extremely low magnetic susceptibility so that they are not magnetized by the fields created in the equipment.



**Introduction****RADIALL NON-MAGNETIC CONNECTORS**

Radiall connectors are specified for coils because they are manufactured with materials especially adapted to non-magnetism (with relative permittivity  $\mu_r$  close to 1). Each rod of raw material is selected based on a direct measurement with a vibrant magnetometer, with the highest quality of surface plating such as BBR (Bright Bronze Radiall), or NPGR (gold plated over a non-magnetic nickel phosphorous).

Our non-magnetic connectors have a susceptibility of around  $10^{-5}$ , as opposed to  $10^{-2}$  for standard connectors made of brass/nickel materials. As a result, our non-magnetic connectors are transparent to the magnetic field, which means no field distortion, a higher SNR, and higher quality images.

**Performance of Radiall non-magnetic RF connectors**

Table of distortion comparison:

	Distortion at 10 mm $\Delta H/H_{\text{ext}}$ with $B_0=1.5$ Tesla	Magnetic susceptibility $\chi$
Radiall non-magnetic connector	$\leq 5 \cdot 10^{-7}$	$\approx 10^{-5}$
Standard non-magnetic connector	$\approx 10^{-5}$	$\approx 10^{-3}$
Brass/nickel connector	$\approx 10^{-4}$	$\approx 10^{-2}$

The relative distortion of a magnetic field of 1.5 T, generated by Radiall non-magnetic connectors is only  $5 \cdot 10^{-7}$  maximum, at a distance of 10 mm from the surface of the connector. Furthermore, they meet the electrical and mechanical characteristics required for any reliable coaxial connector. In addition, these connectors are extremely durable for medical applications.

**Manufacturing**

Manufacturing a Radiall non-magnetic connector involves a special "clean room" environment where all precautions are taken to avoid any contact with ferromagnetic materials during the machining and cleaning process. Radiall follows strict manufacturing guidelines through a quality assurance plan where documented rules are enforced throughout the production line. This quality assurance procedure guarantees the highest level of non-magnetism and repeatability for all Radiall non-magnetic connectors.

MMCX Plug and PCB Receptacle

RIGHT-ANGLE PLUG CRIMP TYPE FOR FLEXIBLE CABLE

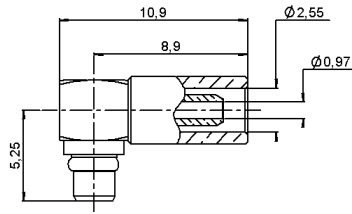

Cable group	Cable group dia.	Part number	Captive center contact	Body material	Finish
RG178 Non-magnetic cable	2/50/S	R110 170 147	Yes	Non-magnetic bronze	BBR

STRAIGHT PCB RECEPTACLE

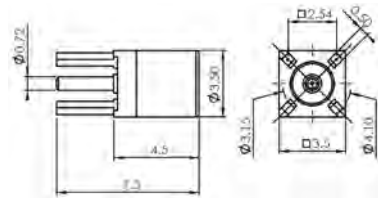

Part number	Captive center contact	Panel drilling	Body material
R110 426 107	Yes	P01	Non-magnetic Bronze

MCX Plug

STRAIGHT PLUG CRIMP TYPE FOR FLEXIBLE CABLE

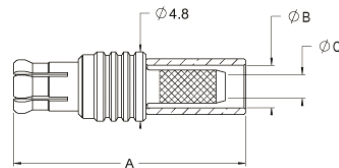

Cable group	Cable group dia.	Part number	Dimensions (mm)			Note	Finish
			A	B	C		
RG178	2/50/S	R113 081 097	16.1	2.55	1.1	-	BBR
RG316	2.6/50/S	R113 082 097	16.1	2.95	1.65	-	
RG316	2.6/50/S	R299 122 097	16.1	2.95	1.65	Full detent	

RIGHT-ANGLE PLUG CRIMP TYPE FOR FLEXIBLE CABLE

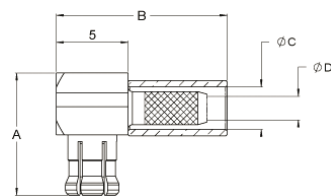

Cable group	Cable group dia.	Part number	Dimensions (mm)				Note	Finish
			A	B	C	D		
RG178	2/50/S	R113 181 097	8.6	11.9	2.55	1.1	-	BBR
RG316	2.6/50/S	R113 182 097	8.6	11.9	2.95	1.65	-	
RG316	2.6/50/S	R299 122 087	8.6	11.9	2.95	1.65	Full detent	

PRODUCT SPECIFICATION: please refer to the standard range

MCX Jack and PCB Receptacles

**STRAIGHT JACK CRIMP TYPE FOR FLEXIBLE CABLE**

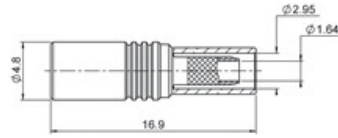

Cable group	Cable group dia.	Part number	Finish
RG316	2.6/50/S	R113 240 097	BBR

**STRAIGHT PCB RECEPTACLE**

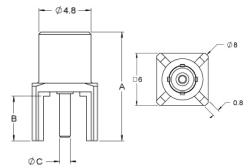
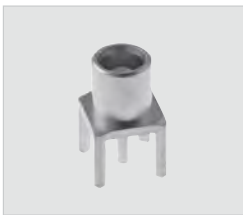

Fig. 1

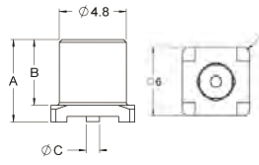

Fig. 2

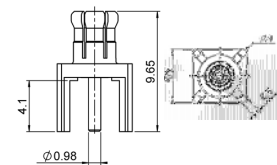
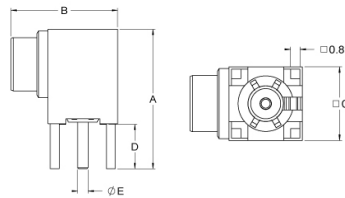

Fig. 3

Part number	Fig.	Dimensions (mm)			Panel drilling	Termination	Finish	Type
		A	B	C				
R113 426 097	1	10	4.1	0.98	P01	Solder legs	Gold over copper	Female
R113 424 097	2	5.9	4.7	0.96	-	SMT		Female
R113 425 097	3	9.65	4.1	0.98	P01	Solder legs	Male	

**RIGHT-ANGLE PCB RECEPTACLE**



Part number	Panel drilling	Termination style	Finish	Type
R113 665 097	P01	Solder legs	Gold over copper	Female

SMP Plug

**RIGHT-ANGLE PLUG CRIMP TYPE FOR FLEXIBLE CABLE**

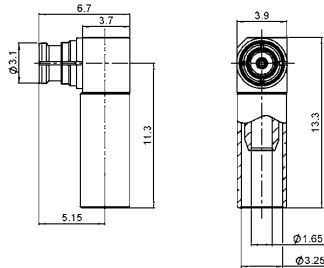

Cable group	Cable group dia.	Part number	Captive center contact	Body material	Finish
RG179 non-magnetic cable	2.6/50/S	R222 900 357	Yes	Non-magnetic bronze	BBR

PRODUCT SPECIFICATION: please refer to the standard range

SMP Receptacle

STRAIGHT SMT RECEPTACLE

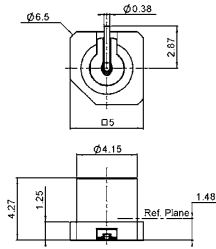
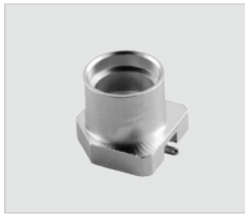

Part number	Retention	Captive center contact	Body material	Finish
R222 941 324	Limited detent	Yes	Non-magnetic bronze	Gold over copper

SMB Plugs and Jack

STRAIGHT PLUG FULL CRIMP TYPE FOR FLEXIBLE CABLE

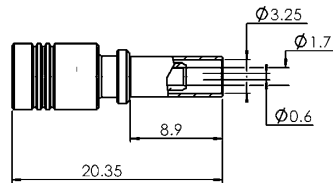

Cable group	Cable group dia.	Part number	Captive center contact	Body material	Finish
RG179, RG316 non-magnetic cable	2.6/50+75/S	R114 082 107	Yes	Non-magnetic bronze	BBR

RIGHT-ANGLE PLUG CRIMP TYPE FOR FLEXIBLE CABLE

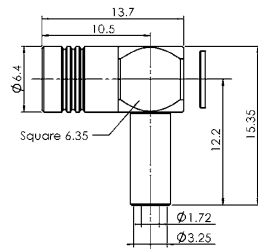
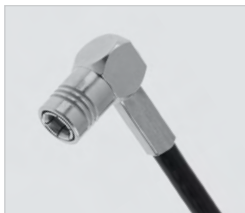

Cable group	Cable group dia.	Part number	Captive center contact	Body material	Finish
RG179, RG316 non-magnetic cable	2.6/50+75/S	R114 186 197	Yes	Non-magnetic bronze	BBR

STRAIGHT BULKHEAD JACK CRIMP TYPE FOR FLEXIBLE CABLE

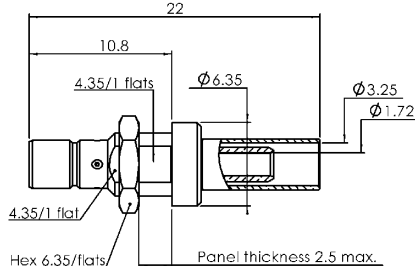

Cable group	Cable group dia.	Part number	Captive center contact	Panel drilling	Body material	Finish
RG316 non-magnetic cable	2.6/50+75/S	R114 313 197	Yes	P02	Non-magnetic bronze	BBR

PRODUCT SPECIFICATION: please refer to the standard range

## SMB Receptacle

### STRAIGHT MALE RECEPTACLE FOR PCB

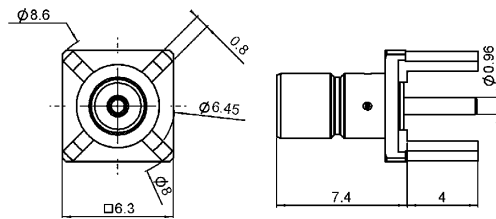
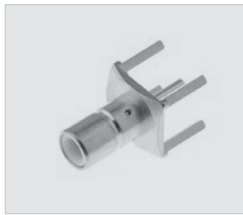

Part number	Body material	Finish
R114 426 147	Non-magnetic bronze	Gold over copper

### RIGHT-ANGLE RECEPTACLE FOR PCB, SOLDER LEGS

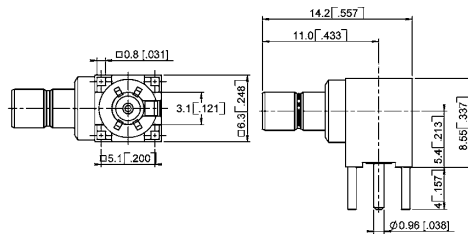

Part number	Captive center contact	Body material	Finish
R114 665 107	Yes	Non-magnetic bronze	Gold over copper

## BNC Plugs and Jack

### STRAIGHT PLUG FULL CRIMP TYPE

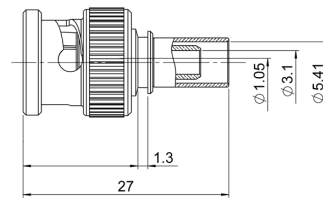

Cable group	Cable group dia.	Part number	Captive center contact	Body material	Finish
RG58 / RG141	5/50S	R141 082 097	Yes	Non-magnetic bronze	BBR / Gold

### RIGHT-ANGLE PLUG CRIMP TYPE FOR FLEXIBLE CABLE

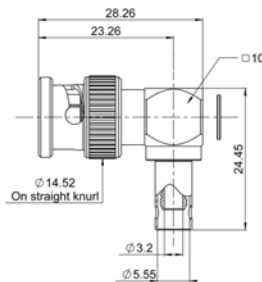

Cable group	Cable group dia.	Part number	Captive center contact	Body material	Finish
RG58 / RG141	5/50S	R141 182 177	Yes	Non-magnetic bronze	BBR / Gold

### STRAIGHT BULKHEAD JACK SOLDER TYPE FOR SEMI RIGID CABLE

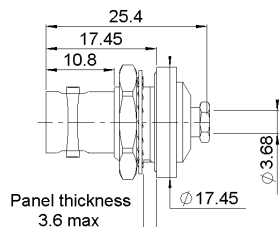

Cable group	Cable group dia.	Part number	Captive center contact	Body material	Finish	Note
RG402	.141"	R141 338 007	No	Non-magnetic bronze	BBR / Gold	Panel sealed

Cable Terminals

**RIGHT-ANGLE TERMINAL SOLDER TYPE FOR FLEXIBLE CABLES**

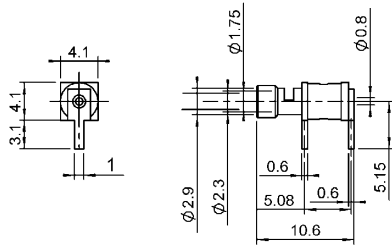

Cable group	Cable group dia.	Part number	Panel drilling	Body material	Finish
RG-174, RG-316, RD-316, RG-179, RD-179	2.6/50+75	R280 220 027	P03	Non-magnetic bronze	Gold over copper

**STRAIGHT TERMINAL SOLDER TYPE FOR SEMI-RIGID CABLES**

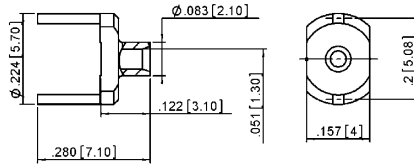

Cable group	Cable group dia.	Part number	Panel drilling	Body material	Finish
RG-174, RG-316, RD-316, RG-179, RD-179	.047	R280 287 107	P04	Non-magnetic bronze	Gold over copper

PRODUCT SPECIFICATION: please refer to the standard range

SIMPLIFICATION IS OUR INNOVATION

### Non-magnetic Cable Assemblies

Radiall also offers a standard range of non-magnetic cable assemblies fit to work within the B<sub>0</sub> magnetic field. The cables are not sold separately.

In order to meet our customers specific project requirements, Radiall provides worldwide technical support.

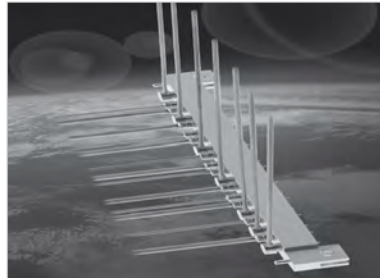

Cable type	Cable group dia.	Part number
RG-178 non-magnetic	2/50/S	C291 140 087
RG-316 non-magnetic	2.6/50/S	C291 170 079
RG-400 non-magnetic	5/50/S	C291 324 079
.085" semi-rigid	.085	C291 851 001
.141" semi-rigid	.141	C291 861 061

### Panel Drilling

P01

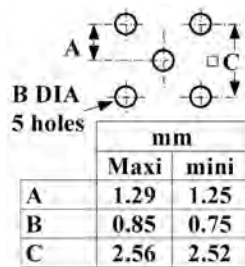

P02

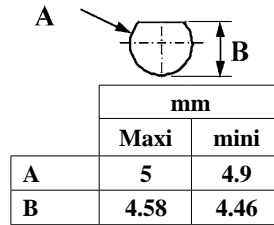

P03

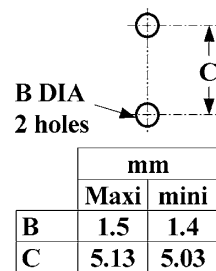

P04

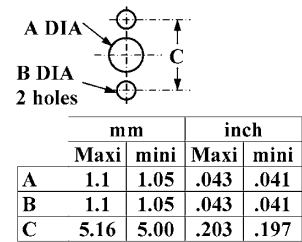

P05

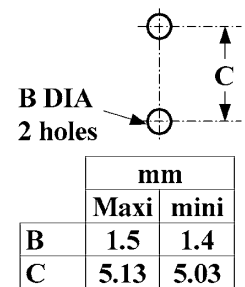

P06

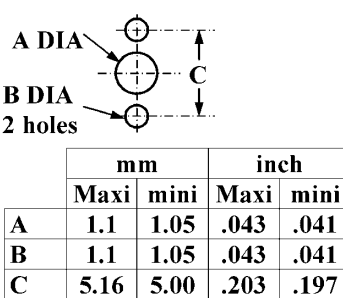

PRODUCT SPECIFICATION: please refer to the standard range



NOTE



# NOTE





## ADAPTERS

R191/R192

**Contents****BETWEEN SERIES 50Ω ADAPTERS**

**Adapters for Radiall propriety interfaces: MC-CARD, MOEBIUS, MQ (MiniQuick), R-MCX, QMA, QN and QRE series** (needed to connect to your analyzer)

Finder guide .....	16-4
Drawing .....	16-10 to 16-12

**Adapters with high frequency and precision connectors: N18 GHZ, PC7, SMA2.4, SMA2.9, SMA3.5 and TNC18 GHZ series**

Finder guide .....	16-5
Drawing .....	16-13 to 16-15

**Adapters with all standard series: 1.0/2.3, 7/16, BMA, BNC, C, HN, MCX, MMBX, MMCX, N, SMA, SMB, SMC, SMP, SSMA, SSMC, TNC and UHF series**

Finder guide .....	16-6 to 16-7
Drawing .....	16-16 to 16-26

**Push-on adapters: N, SMA and TNC series** (for time savings during testing activity)

Finder guide .....	16-5
Drawing .....	16-27

**BETWEEN SERIES 75Ω ADAPTERS**

**Adapters with standard series: 1.0/2.3, 1.6/5.6, BNC, MCX and N series**

Finder guide .....	16-4
Drawing .....	16-28
Panel drilling .....	16-29

**IN SERIES 50Ω AND 75Ω ADAPTERS**

Finder guide .....	16-8 to 16-9
--------------------	--------------

**Introduction**

Radiall offers an extended range of coaxial connectors and adapters. The following finder guides and drawings will help you to find the between series adapters that fit your needs. Adapters are categorized into one of the following families identified below.

**Finder Guide****75Ω ADAPTERS**

1 <sup>st</sup> interface		2 <sup>nd</sup> interface		Part number	Page
Series	Gender	Series	Gender		
BNC	F	N	F	R192 418 000	16-11
			M	R192 421 000	
	M	N	F	R192 419 000	
N	F	BNC	F	R192 418 000	
			M	R192 419 000	
	M		F	R192 421 000	

**50Ω ADAPTERS FOR RADIAL PROPRIETARY INTERFACES**

1 <sup>st</sup> interface		2 <sup>nd</sup> interface		Part number	Page	
Series	Gender	Series	Gender			
MC-Card	F	SMA	F	R191 366 091	16-11	
	M			R191 366 071		
Moebius	M	SMA	F	R191 857 000		
R-MCX	F	SMA	F	R191 976 020	16-12	
			M	R191 977 020		
	M		R191 984 008			
QLI	F	7/16	M	R191 663 000		
			F	R191 665 000		
		N	M	R191 793 000		
	M	7/16	M	R191 662 000		
			F	R191 664 000		
		N	M	R191 792 000		
QMA	F	N	F	R191 764 000		16-13
			M	R191 762 000		
		SMA	F	R191 913 000		
	M		R191 912 000			
	M		N	F	R191 763 000	
		M		R191 765 000		
SMA		F	R191 911 000			
QN	F	7/16	M	R191 923 000	16-14	
			N	F		
		R191 760 000				
	M	F		R191 759 000		
			M	R191 757 000		
		QRE	F	SMA		M
SMA3.5	F			R191 946 700	16-14	
M	SMA		F	R191 926 L01	16-18	
	SMA3.5		F	R191 944 700	16-18	
MMS	M	SMA3.5	F	R191 975 781	16-14	
UMP H2	M	SMA	F	R107 009 901		
UMP H3	M	SMA	F	R107 009 903		

## Finder Guide

## 50Ω ADAPTERS WITH HIGH FREQUENCY AND PRECISION CONNECTORS

1 <sup>st</sup> interface		2 <sup>nd</sup> interface		Part number	Page		
Series	Gender	Series	Gender				
N18	F	SMA3.5	F	R191 330 000	16-15		
			M	R191 333 000			
			F	R191 326 000			
	M		F	R191 328 000			
			M	R191 324 000			
			F	R191 015 000			
PC7	F	BNC	M	R191 013 000		16-16	
			F	R191 027 000			
		N	M	R191 025 000			
			F	R191 011 000			
		SMA	M	R191 009 000			
			F	R191 012 000			
	SMA3.5	M	R191 010 000				
		F	R191 007 000				
	SMB	F	R191 003 000				
		F	R191 970 091				
	2.4 mm	F	SMA2.9	M	R191 970 071		16-34
				F	R191 565 000		
SMPM			M	R191 564 000	16-35		
			F	R191 970 081			
M			SMA2.9	M	R191 970 061	16-6	
				F	R191 563 000		
SMPM		M	R191 562 000	16-35			
		F	R191 970 091				
SMA2.9		F	SMA2.4	M	R191 970 081	16-16	
				F	R191 969 002		
			SMP	M	R191 968 001		16-17
				F	R191 959 000		
	SMPM		M	R191 958 000			
			F	R191 970 071			
	M	SMA2.4	M	R191 970 061	16-16		
			F	R191 967 002			
		SMP	M	R191 966 001		16-17	
			F	R191 957 000			
		SMPM	M	R191 956 020			
			F	R191 958 020			
	SMA3.5	F	MMS	M	R191 975 781		16-15
			N18	F	R191 330 000		
				M	R191 333 000		
				F	R191 328 000		
			PC7	F	R191 012 000	16-16	
				F	R191 946 700		
M		R191 944 700					
TNC18		F	R191 316 700	16-18			
		F	R191 326 000				
		M	R191 324 000				
TNC18		F	SMA	F	R191 318 700	16-18	
				M	R191 314 730		
	F			R191 314 700			
	SMA 3.5		F	R191 316 700	16-33		
			F	R191 010 000			
			M	R191 010 000			

## 50Ω PUSH-ON ADAPTERS

1 <sup>st</sup> interface		2 <sup>nd</sup> interface		Part number	Page
Series	Gender	Series	Gender		
MCX Push-on	F	SMA	M	R191 977 520	16-18
N Push-on	M	N	F	R161 791 500	
TNC Push-on	M	TNC		R143 713 000	
SMA Push-on	M	SMA	R125 792 501		
	F		R125 791 501		

## Finder Guide

## TEST PROBE ADAPTERS

1 <sup>st</sup> interface		2 <sup>nd</sup> interface		Part number	Page
Series	Gender	Series	Gender		
SMA	F	MMBX	F	R191 389 800	16-19
		MML H2.5 & H2.0	F	R191 597 800	
		SMA	F	R191 300 800	
		SMB	M	R191 201 800	
		SMP	M	R191 844 800	
		SMP-MAX	F	R191 553 800	

## 50Ω ADAPTERS WITH ALL STANDARD SERIES

1 <sup>st</sup> interface		2 <sup>nd</sup> interface		Part number	Page	
Series	Gender	Series	Gender			
2B4 (Banana plug 4mm)	F	BNC	M	R191 453 000	16-20	
	M		F	R191 455 000		
4.1-9.5	F	4.3-10	M	R191 598 007	16-22	
4.3-10	F	7/16	M	R191 592 007	16-20	
		N		R191 591 007		
	7/16	F	R191 592 017			
	N		R191 591 017			
	7/16		R191 592 037			
M	7/16	M	R191 592 027	16-22		
	4.1-9.5	F	R191 598 007			
7/16	F	4.3-10	M	R191 592 017	16-20	
			F	R191 592 037	16-22	
		HN	M	R191 908 000	16-21	
		N	F	R191 723 000		
		M	QLI	M	R191 720 000	16-12
	QLI		F	R191 665 000		
	QLI		M	R191 664 000		
	BMA	F	SMA	F	R191 353 711	16-23
				M	R191 353 701	
			SMP	M	R191 815 110	
M		SMA	F	R191 352 001	16-24	
			M	R191 355 001		
		SMP	M	R191 354 001		
			F	R191 350 001		
			F	R191 811 110		
BNC	F	2B4	M	R191 455 000	16-20	
		C	M	R191 429 000	16-24	
		HN	M	R191 449 000		
		MCX	F	R191 477 120	16-25	
		N	F	R191 422 000		
			M	R191 424 000		
		PC7	M	R191 421 000	16-15	
		SMA	M	R191 303 000		
		SMB	F	M	R191 215 000	16-25
					5512-7501-000	
					R191 212 500	
			M	R191 213 000		
R191 212 000	16-26					

1 <sup>st</sup> interface		2 <sup>nd</sup> interface		Part number	Page	
Series	Gender	Series	Gender			
BNC	F	SMC	F	R191 123 000	16-26	
			M	R191 124 000		
			M	R191 120 000		
		TNC	M	5510-1501-000	16-22	
			M	R191 405 000	16-26	
	M	2B4	F	R191 447 000	16-20	
			F	R191 453 000		
		N	F	R191 454 000	16-26	
			M	R191 419 000		
			M	R191 417 000		
	C	F	PC7	-	R191 013 000	16-15
				F	R191 305 000	
			SMA	M	R191 301 000	16-27
				F	R191 214 000	
				F	5405-1501-000	
M		SMB	M	R191 209 000	16-27	
			M	5404-1501-000	16-22	
		SMC	F	5403-1501-000		
			M	5402-1501-000		
			M	R191 117 000		
LC	F	TNC	F	R191 403 000	16-27	
			F	R191 445 000		
		UHF	F	R191 708 000	16-28	
			M	R191 703 000		
			M	R191 703 000		
	HN	M	BNC	F	R191 429 000	16-24
			HN	F	R191 933 000	16-28
			N	F	R191 705 000	
		F	7/16	M	R191 907 000	16-21
			C	M	R191 933 000	16-28
MCX	M	7/16	F	R191 908 000	16-21	
		BNC	F	R191 449 000	16-28	
		N	F	R191 737 000		
	F	N	F	R191 741 000	16-28	
		7/16	F	R191 908 000	16-21	
MMCX	M	BNC	F	R191 741 000	16-28	
			F	R191 449 000		
		N	F	R191 737 000		
	MMCX	F	N	F	R191 741 000	16-28
				F	R191 449 000	
M		BNC	F	R191 737 000	16-24	
			F	R191 477 120		
		SMA	F	R191 388 000		
MMBX	F	SMA	M	R191 386 000	16-29	
			M	R191 387 107		
		F	R191 387 000			
	M	SMA	M	R191 385 000		
			F	R191 399 100		
SMA	F	M	R191 398 020	16-29		
			5512-7501-000			
			R191 212 500			
	M	R191 389 400				
		R191 389 300				
SMB	F	M	R191 389 200	16-29		
			R191 389 300			
			R191 389 200			
	M	R191 389 100				
		R191 389 100				

## Finder Guide

## 50Ω ADAPTERS WITH ALL STANDARD SERIES

1 <sup>st</sup> interface		2 <sup>nd</sup> interface		Part number	Page
Series	Gender	Series	Gender		
N	F	4.3-10	M	R191 591 017	16-30
		7/16	F	R191 723 000	16-21
			M	R191 722 000	
		BNC	F	R191 422 000	16-25
				R191 424 000	
		C	F	R191 419 000	16-26
				R191 708 000	
		HN	M	R191 737 000	16-28
				R191 741 000	
		PC7	-	R191 027 000	16-15
		QLI	M	R191 794 000	16-12
		QMA	F	R191 764 000	16-13
				R191 763 000	
		QN	F	R191 760 010	16-14
				R191 760 000	
		SMA	F	R191 759 000	16-30
				R191 334 000	
				R191 332 000	
				R191 331 000	
				R191 381 000	
		SMA	M	R191 327 000	16-30
	R191 377 000				
	R191 377 000				
	SMB	F	R191 239 000	16-31	
			R191 236 000		
	TNC	F	R191 514 000	16-31	
			R191 511 000		
	UHF	M	R191 733 000		
	M	4.3-10	F	R191 591 007	16-20
				R191 720 000	16-21
				R191 721 000	
		BNC	F	R191 421 000	16-25
				R191 417 000	16-26
		C	F	R191 703 000	16-28
		PC7	-	R191 025 000	16-15
		QLI	F	R191 793 000	16-12
		QLI	M	R191 792 000	16-12
				R191 792 000	
		QMA	F	R191 762 000	16-13
				R191 765 000	
		QN	M	R191 757 000	16-14
		SMA	F	R191 329 000	16-31
R191 325 000					
SMB		M	R191 233 000	16-31	
			R191 513 000		
TNC		F	R191 513 050	16-31	
	R191 513 050				
UHF	F	R191 731 000			
SMA	F	BMA	F	R191 353 711	16-23
			R191 353 701		
		BMA	M	R191 352 001	16-24
				R191 355 001	
		BNC	M	R191 305 000	16-27
		MC-Card	F	R191 366 091	16-11
				R191 366 071	
		MCX	F	R191 388 000	16-28
				R191 387 107	
		MMBX	F	R191 389 400	16-29
				R191 389 200	
		MMCX	F	R191 399 100	16-29
				R191 398 020	
		Moebius	M	R191 857 000	16-11

1 <sup>st</sup> interface		2 <sup>nd</sup> interface		Part number	Page
Series	Gender	Series	Gender		
SMA	F	N	F	R191 334 000	16-30
				R191 332 000	
				R191 331 000	
				R191 381 000	
		BNC	M	R191 329 000	16-31
				R191 011 000	16-16
		PC7	F	R191 913 000	16-13
		QMA	M	R191 911 000	
		QRE	M	R191 926 L01	16-14
		R-MCX	F	R191 976 020	16-12
				R191 203 007	16-32
		SMB	M	R191 201 007	
				R191 844 002	
		SMP	M	R191 843 001	16-23
				R191 843 421	
				R191 843 401	
				R191 843 429	
		SMP	M	R191 843 409	16-23
				R191 843 409	
		SMPM	M	5964-9513-001	16-32
		SSMA	F	5965-9513-000	
	SSMC	F	R191 349 000	16-32	
	TNC	F	5945-9503-000	16-33	
			R191 315 000		
	TNC	M	R191 365 000	16-33	
			R191 313 000		
	TNC18 GHz	F	R191 318 700	16-18	
			R191 314 730	16-33	
	TNC18 GHz	F	R191 314 700	16-33	
			R191 351 701	16-23	
	BMA	M	R191 354 001	16-24	
	BNC	F	R191 350 001	16-24	
			R191 303 000		
	BNC	M	R191 301 000	16-25	
			R191 301 000	16-27	
	MCX	F	R191 386 000	16-28	
			R191 385 000		
	MMCX	M	R191 389 300	16-29	
			R191 389 100		
	N	F	R191 327 000	16-30	
			R191 377 000		
	N	M	R191 325 000	16-31	
R191 325 000					
PC7	F	R191 009 000	16-16		
QMA	F	R191 912 000	16-13		
		R191 910 000			
QRE	F	R191 927 L01	16-14		
R-MCX	F	R191 977 020	16-12		
		R191 984 008			
SMB	M	R191 200 007	16-33		
SMC	F	R191 374 000	16-33		
SMP	F	R191 842 002	16-33		
		R191 841 001			
SSMA	M	R191 841 001	16-34		
		R191 347 000			
SSMC	M	5938-1503-000	16-34		
		R191 311 000			
TNC	F	R191 311 000	16-34		
		R191 309 000			
TNC	M	R191 309 000	16-34		
		R191 309 000			



## Finder Guide

## 50Ω ADAPTERS WITH ALL STANDARD SERIES

1 <sup>st</sup> interface		2 <sup>nd</sup> interface		Part number	Page	
Series	Gender	Series	Gender			
SMB	F	BNC	F	R191 215 000	16-25	
			M	5512-7501-000		
			F	R191 214 000	16-27	
		M	BNC	F	5405-1501-000	16-22
				M	R191 239 000	16-30
				F	R191 007 000	16-16
	M	N	F	R191 203 007	16-32	
			M	R191 212 500	16-25	
			F	R191 213 000		
		SMA	BNC	F	R191 212 000	16-26
				M	R191 209 000	16-27
				F	5404-1501-000	16-22
SMC	F	BNC	F	R191 123 000	16-26	
			M	5403-1501-000		
		M	BNC	F	R191 003 000	16-16
	M			R191 374 000	16-33	
	F			R191 120 000	16-26	
	SMP	F	BMA	M	R191 811 110	16-24
F				R191 844 002	16-32	
M				R191 842 002	16-33	
SMA2.9			F	R191 969 002	16-17	
			M	R191 967 002		
			F	R191 815 110		16-23
M		SMA	F	R191 843 001	16-32	
			M	R191 843 429	16-23	
			F	R191 843 409		
		SMA2.9	SMA	F	R191 841 001	16-34
				M	R191 968 001	16-17
				F	R191 966 001	
SMPM	M	SMA	F	R191 570 100	16-34	

1 <sup>st</sup> interface		2 <sup>nd</sup> interface		Part number	Page	
Series	Gender	Series	Gender			
SMPM	F	2.4 mm	F	R191 565 000	16-34	
			M	R191 563 000		
			F	R191 959 000	16-17	
		SMA 2.9	M	R191 957 000		
			F	R191 564 000		16-35
			M	R191 562 000		
	SMA	F	5964-9513-001			
		M	5965-9513-000			
		F	R191 958 000			
	M	SMA 2.9	M	R191 958 020	16-34	
			F	R191 956 020		
			M	R191 956 020		
SMP		M	SMA	F	R191 570 100	16-34
				M	R191 349 000	16-32
SSMA		F	SMA	M	R191 347 000	16-34
	F			5945-9503-000	16-32	
SSMC	M	SMA	M	5938-1503-000	16-34	
			F	R191 403 000	16-27	
TNC	F	BNC	M	R191 514 000	16-30	
			F	R191 513 000	16-31	
			M	R191 513 050		
		SMA	F	F	R191 315 000	16-33
				M	R191 365 000	
				F	R191 311 000	
	M	BNC	F	R191 405 000	16-26	
			M	R191 511 000	16-31	
			F	R191 313 000	16-33	
		SMA	M	F	R191 309 000	16-34
				M	R191 445 000	16-27
				F	R191 731 000	16-31
UHF	F	BNC	F	R191 447 000	16-26	
			M	R191 733 000	16-31	
			F	R191 733 000	16-31	

## Finder Guide

## 50Ω AND 75Ω IN SERIES ADAPTERS (for reference only)

In series adaptors	Part number	Gender (Male - Female)				Type					Function								
		Side 1	Side 2	Side 3	Side 4	Str.	R/A	U	T	X	Bulkhead	Sealed		Panel isolated	Flange	Press-in	Locked on panel	Hermetic	
												Panel	Inside line						
7/16	R185 703 000	M	M			X													
	R185 705 000	F	F			X													
	R185 707 000	M	F			X													
	R185 710 000	F	F			X													
2.4 mm	R185 730 020	F	F			X					X	X			X				
	R327 703 000	M	M			X													
	R327 704 000	M	F			X													
	R327 705 000	F	F			X													
4.1-9.5	R327 771 000	M	F						X										
	R170 703 007	M	M			X													
BNC	R141 703 000	M	M			X													
	R141 704 000	F	F			X													
	R141 710 000	F	F			X													
	R141 717 000	F	F			X													
	R141 720 000	F	F			X					X								
	R141 723 000	F	F			X					X			X					
	R141 723 161	F	F			X					X			X					
	R141 730 000	F	F			X					X	X							
	R141 753 000	F	F			X					X	X						X	
	R141 770 000	M	F					X											
	R141 780 000	F	F	M					X										
	R141 782 000	F	F	F					X										
	R141 789 000	F	M	F					X										
	R141 799 000	F	F		M					X									
BNC 75 Ω	R142 703 000	M	M			X													
	R142 704 000	F	F			X													
	R142 710 000	F	F			X													
	R142 720 000	F	F			X					X								
	R142 723 000	F	F			X					X								
	R142 770 000	M	F					X						X					
	R142 780 000	F	F	M															
	R142 782 000	F	F	F															
BNC 75 HDTV	R142 789 000	M	F	F															
	R142 703 703	M	M			X													
BNC HT	R142 720 700	F	F			X					X								
	R316 704 000	F	F			X					X	X	X						
C	R316 754 000	F	F			X													
	R166 705 000	F	F			X													
DT-F	R166 770 000	M	F					X											
	R166 753 000	F	F			X					X	X						X	
HN	R139 705 023	F	F			X													
	R176 754 000	F	F			X					X	X	X					X	
MCC2	R176 754 150	F	F			X					X	X							
	R176 770 000	M	F					X											
MCX	R199 001 703	M	M			X										X			
	R199 001 713	M	M			X													
	R199 001 733	M	M			X											X		
MMCX	R113 704 000	F	F			X													
	R110 704 103	F	F			X					X								
MMT	R209 703 070	M	M			X													
	R210 703 507	F	F Slide on			X													
N	R161 703 000	M	M			X													
	R161 705 000	F	F			X													
	R161 715 000	F	F			X													
	R161 730 000	F	F			X					X	X							
	R161 753 000	F	F			X					X	X	X					X	
	R161 771 000	M	F					X											
	R161 780 000	F	F	M															
	R161 782 000	F	F	F															
N18 GHz	R161 791 500	F	F Slide on			X													
	R161 791 530	M	F			X													
	R163 703 001	M	M			X													
N75 Ω	R163 705 001	F	F			X													
	R163 708 001	M	F			X													
QMA	R162 703 000	M	M			X													
	R162 705 000	F	F			X													
	R123 703 000	M	M			X													
QN	R123 704 000	M	F			X													
	R123 705 000	F	F			X													
	R164 705 000	F	F			X													
	R164 708 000	M	F			X													

Note: drawings can be found in the corresponding series' section

## Finder Guide

## 50Ω AND 75Ω IN SERIES ADAPTERS (for reference only)

In series adaptors	Part number	Gender (Male - Female)				Type					Function								
						Str.	R/A	U	T	X	Bulkhead	Sealed		Panel isolated	Flange	Press-in	Locked on panel	Hermetic	
		Side 1	Side 2	Side 3	Side 4							Panel	Inside line						
SHV	R317 720 000	M	M			X					X								
	R125 703 000	M	M			X													
SMA	R125 703 001	M	M			X													
	R125 704 000	M	F			X													
	R125 704 001	M	F			X													
	R125 705 000	F	F			X													
	R125 705 001	F	F			X													
	R125 720 000	F	F			X					X								
	R125 720 001	F	F			X					X								
	R125 753 000	F	F			X					X	X	X					X	
	R125 753 001	F	F			X					X	X	X					X	
	R125 771 000	M	F					X											
	R125 771 001	M	F					X											
	R125 780 000	F	F	M						X									
	R125 780 001	F	F	M						X									
	R125 781 000	F	F	F						X									
	R 125 781 001	F	F	F						X									
	R125 791 501	F	M Slide on				X												
	R125 792 501	F	F Slide on				X												
	SMA 2.9	R127 703 001	M	M			X												
		R127 704 001	M	F			X												
		R127 705 001	F	F			X												
R127 712 001		F	F			X													
R127 732 100		F	F			X					X	X			X				
R127 753 000		F	F			X					X	X	X					X	
R127 870 001		F	F			X													
R127 871 001		M	M			X													
SMB	R127 872 001	M	F			X													
	R114 703 000	M	M			X													
	R114 704 000	F	F			X													
	R114 720 000	M	M			X					X								
	R114 753 000	M	M			X					X	X	X					X	
	R114 780 000	M	M	F															
	R114 781 000	M	M	M															
	5207-1501-000	M	M	M					X										
	5222-1501-000	M	M			X					X								
	5213-1501-000	M	M			X													
	5215-1501-000	M	M	F					X										
	5216-1501-000	F	F			X													
5208-1501-000	F	F	F					X											
SMC	R112 720 000	M	M			X					X								
	R112 780 000	M	M	F					X										
SSMA	R121 703 000	M	M			X													
	R121 705 000	F	F			X													
SSMB	R121 705 001	F	F			X													
	7222-1501-600	M	M			X					X								
SSMC	7122-1502-000	M	M			X					X								
	R143 703 000	M	M			X													
TNC	R143 704 000	F	F			X													
	R143 710 000	F	F			X													
	R143 713 000	F	M Slide on			X											X		
	R143 713 200	M	F			X											X		
	R143 720 000	F	F			X					X								
	R143 753 000	F	F			X					X	X	X					X	
	R143 770 000	M	F						X										
	R143 780 000	F	F	M						X									
TNC18	R143 782 000	F	F	F					X										
	R143 703 700	M	M			X													
	R143 704 700	F	F			X													
	R143 705 700	M	F			X													
	R143 710 700	F	F			X											X		
UHF	R143 730 700	F	F			X					X	X							
	R155 705 000	F	F			X													

**Note:** drawings can be found in the corresponding series' section

75 ohms Adapters

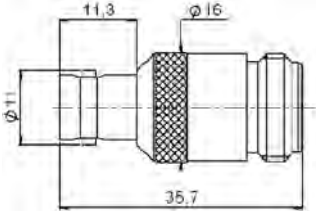

Part number	Interface
R192 418 000	BNC female - N female

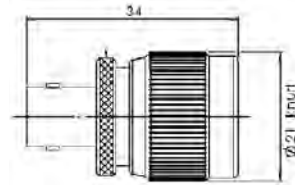

Part number	Interface
R192 421 000	BNC female - N male

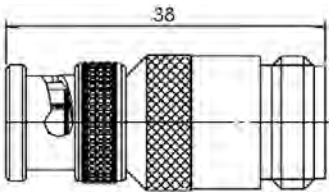

Part number	Interface
R192 419 000	BNC male - N female

Radial Proprietary Interface Adapters

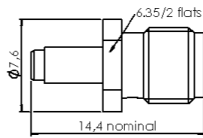

Part number	Interface
R191 366 091	MC-Card female - SMA female

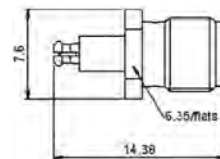

Part number	Interface
R191 366 071	MC-Card male - SMA female

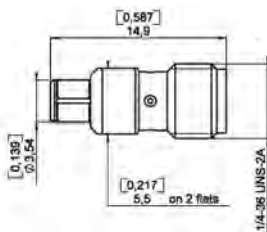

Part number	Interface
R191 857 000	Moebius male - SMA female

ADAPTERS 75Ω & 50Ω

SIMPLIFICATION IS OUR INNOVATION

## Radial Proprietary Interface Adapters

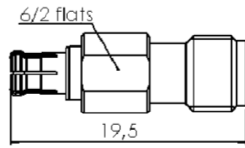

Part number	Interface
R191 976 020	R-MCX female - SMA female

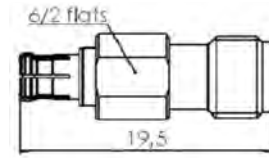

Part number	Interface
R191 977 020	R-MCX female - SMA male

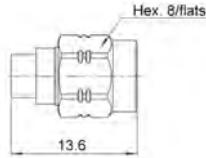

Part number	Interface
R191 984 008	R-MCX male - SMA male

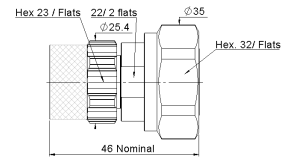

Part number	Interface
R191 663 000	QLI female - 7/16 male

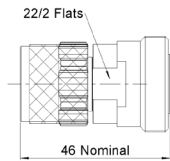

Part number	Interface
R191 665 000	QLI female - 7/16 female

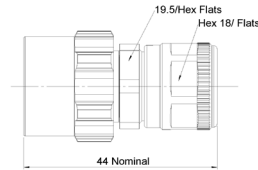

Part number	Interface
R191 793 000	QLI female - N male

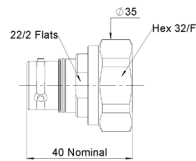

Part number	Interface
R191 662 000	QLI male - 7/16 male

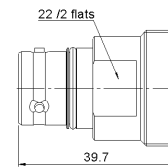

Part number	Interface
R191 664 000	QLI male - 7/16 female

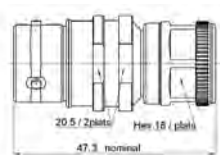

Part number	Interface
R191 792 000	QLI male - N male

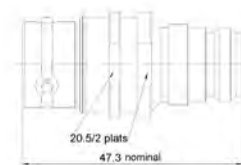

Part number	Interface
R191 794 000	QLI male - N female

Radial Proprietary Interface Adapters

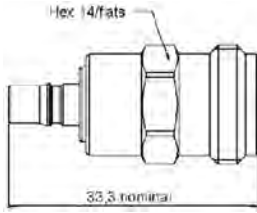

Part number	Interface
R191 764 000	QMA female - N female

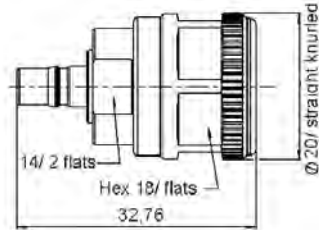

Part number	Interface
R191 762 000	QMA female - N male

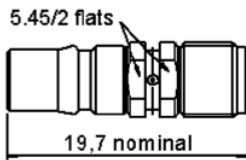

Part number	Interface
R191 913 000	QMA female - SMA female

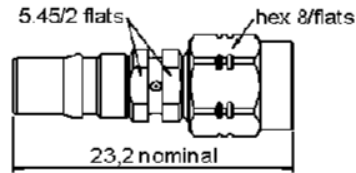

Part number	Interface
R191 912 000	QMA female - SMA male

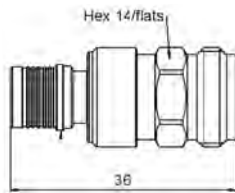

Part number	Interface
R191 763 000	QMA male - N female

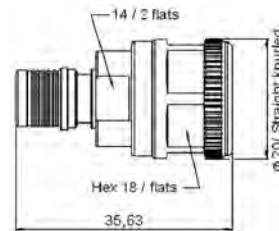

Part number	Interface
R191 765 000	QMA male - N male

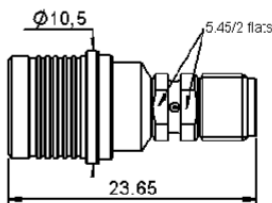

Part number	Interface
R191 911 000	QMA female - SMA female

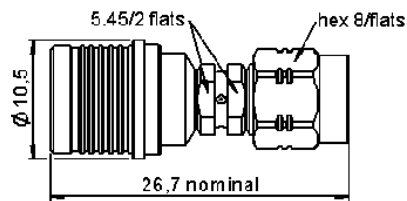

Part number	Interface
R191 910 000	QMA male - SMA male

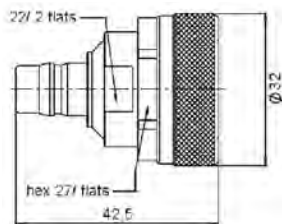

Part number	Interface
R191 923 000	QN female - 7/16 male

## Radial Proprietary Interface Adapters

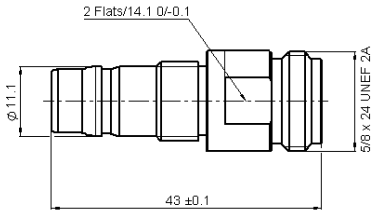

Part number	Interface
R191 760 010	QN female - N female

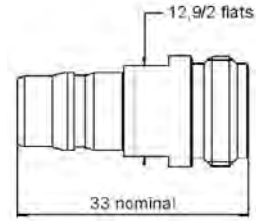

Part number	Interface
R191 760 000	QN female - N female

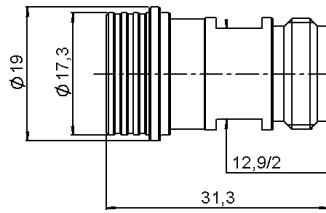

Part number	Interface
R191 759 000	QN male - N female

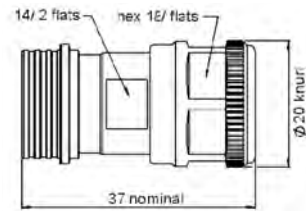

Part number	Interface
R191 757 000	QN male - N male

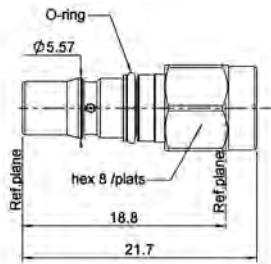

Part number	Interface
R191 927 L01	QRE female - SMA male

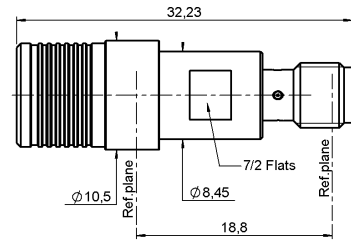

Part number	Interface
R191 926 L01	QRE male - SMA female

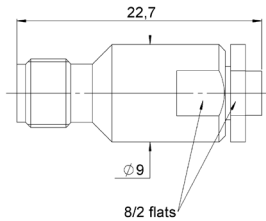

Part number	Interface
R191 975 781	MMS male - SMA 3.5 female

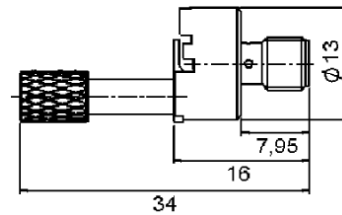

Part number	Interface
R107 009 901	UMP H2 - SMA female

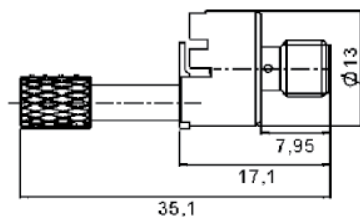

Part number	Interface
R107 009 903	UMP H3 - SMA female

High Frequency and Precision Connector Adapters

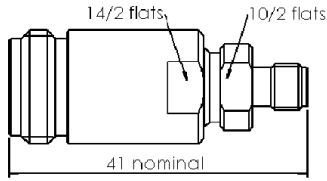

Part number	Interface
R191 330 000	N18 female - SMA3.5 female

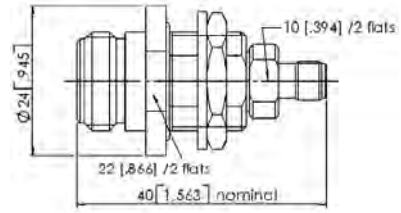

Part number	Interface	Panel drilling
R191 333 000	N18 female - SMA3.5 female	P11

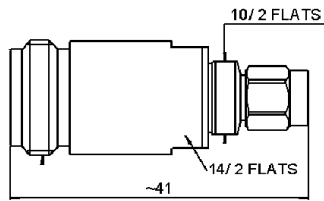

Part number	Interface
R191 326 000	N18 female - SMA3.5 male

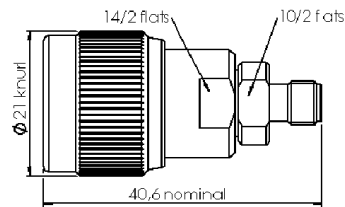

Part number	Interface
R191 328 000	N18 male - SMA3.5 female

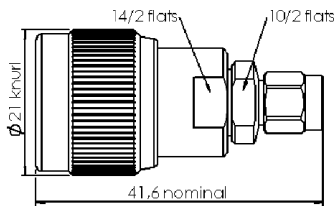

Part number	Interface
R191 324 000	N18 male - SMA3.5 male

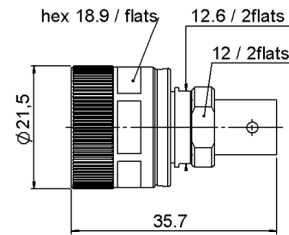

Part number	Interface
R191 015 000	PC7 - BNC female

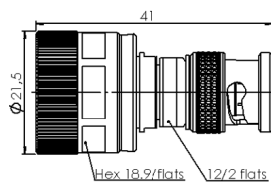

Part number	Interface
R191 013 000	PC7 - BNC male

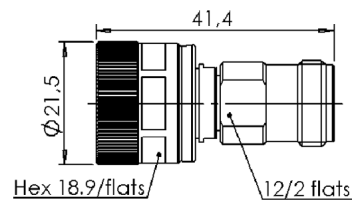

Part number	Interface
R191 027 000	PC7 - N female

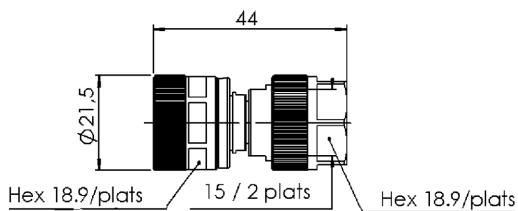

Part number	Interface
R191 025 000	PC7 - N male



## High Frequency and Precision Connector Adapters

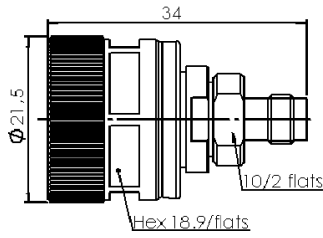

Part number	Interface
R191 011 000	PC7 - SMA female

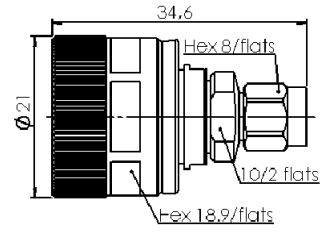

Part number	Interface
R191 009 000	PC7 - SMA male

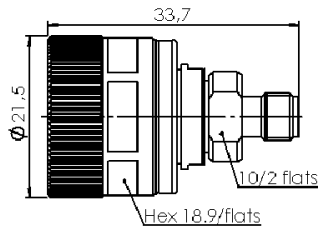

Part number	Interface
R191 012 000	PC7 - SMA3.5 female

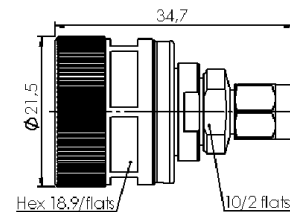

Part number	Interface
R191 010 000	PC7 - SMA3.5 male

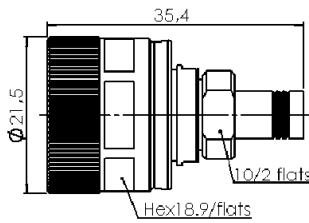

Part number	Interface
R191 007 000	PC7 - SMB female

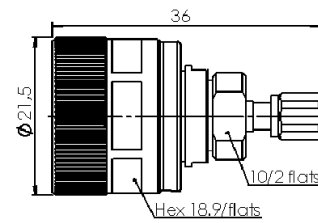

Part number	Interface
R191 003 000	PC7 - SMC female

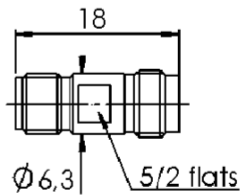

Part number	Interface
R191 970 091	SMA2.4 female - SMA2.9 female

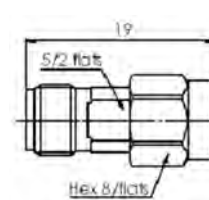

Part number	Interface
R191 970 071	SMA2.4 female - SMA2.9 male

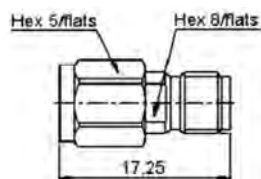

Part number	Interface
R191 970 081	SMA2.4 male - SMA2.9 female

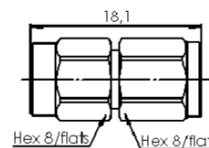

Part number	Interface
R191 970 061	SMA2.4 male - SMA2.9 male

High Frequency and Precision Connector Adapters

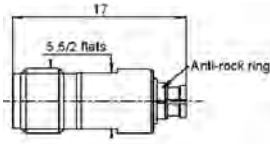

Part number	Interface
R191 969 002	SMA2.9 female - SMP female

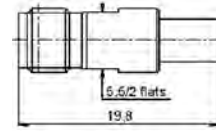

Part number	Interface
R191 968 001	SMA2.9 female - SMP male

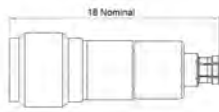

Part number	Interface
R191 959 000	SMA2.9 female - SMPM female

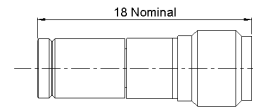

Part number	Interface
R191 958 000	SMA2.9 female - SMPM male

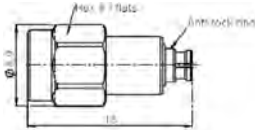

Part number	Interface
R191 967 002	SMA2.9 male - SMP female

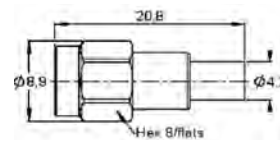

Part number	Interface
R191 966 001	SMA2.9 male - SMP male

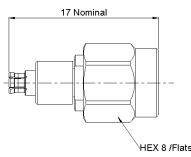

Part number	Interface
R191 957 000	SMA2.9 male - SMPM female

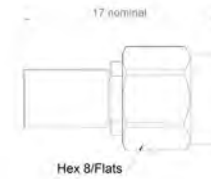

Part number	Interface
R191 956 020	SMA2.9 male - SMPM male

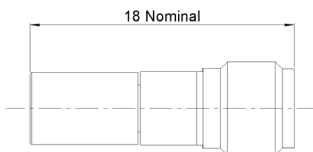

Part number	Interface
R191 958 020	SMA2.9 male - SMPM male

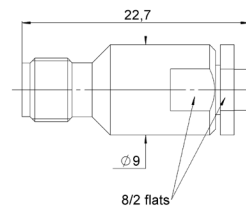

Part number	Interface
R191 975 781	SMA3.5 female - MMS male

## High Frequency and Precision Connector Adapters

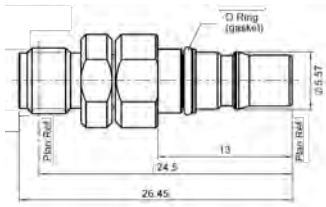

Part number	Interface
R191 946 700	SMA3.5 female - QRE male



Part number	Interface
R191 944 700	SMA3.5 female - QRE male

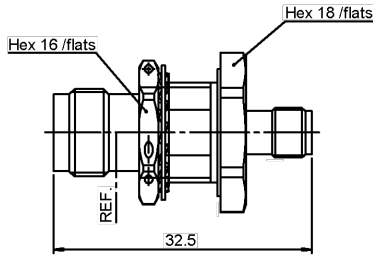

Part number	Interface	Panel drilling
R191 316 700	TNC18 female - SMA3.5 female	P04

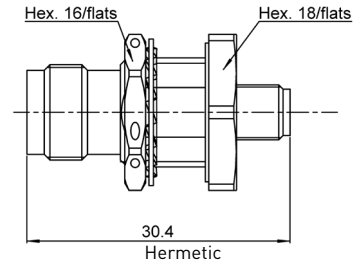

Part number	Interface	Panel drilling
R191 318 700	TNC18 female - SMA female	P04

## Push - On Adapters

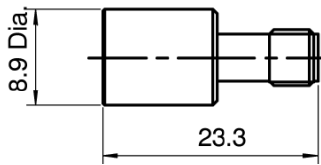

Part number	Interface
R125 791 501	SMA Push-on male - SMA female

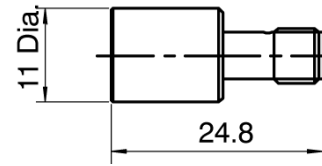

Part number	Interface
R125 792 501	SMA Push-on female - SMA female

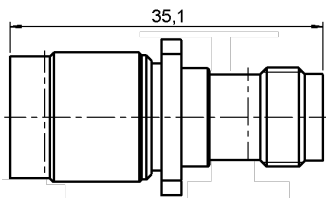

Part number	Interface	Panel drilling
R143 713 000	TNC Push-on male - TNC female	P02

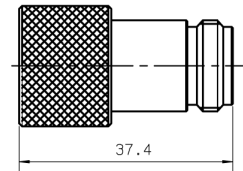

Part number	Interface
R161 791 500	N Push-on male - N female

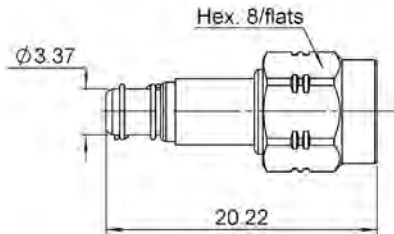

Part number	Interface
R191 977 520	MCX Push-on female - SMA male

Test Probe Adapters

ADAPTERS 50Ω

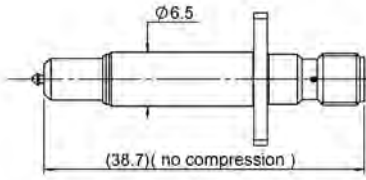

Part number	Interface
R191 389 800	SMA female - MMBX female

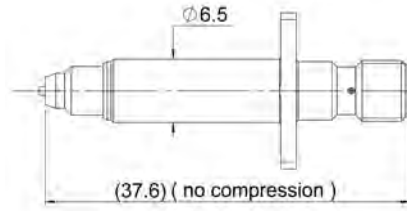

Part number	Interface
R191 597 800	SMA female - MML H2.5 & H2.0 female

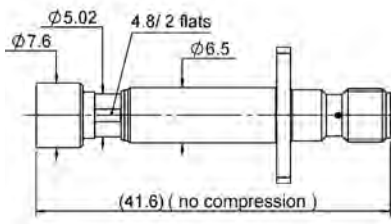

Part number	Interface
R191 300 800	SMA female - SMA female

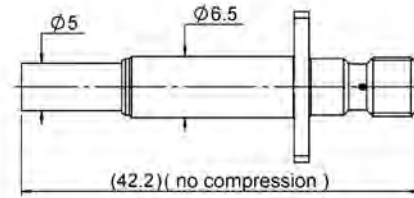

Part number	Interface
R191 201 800	SMA female - SMB male

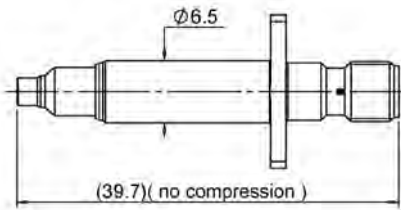

Part number	Interface
R191 844 800	SMA female - SMP female

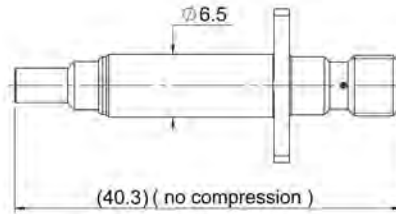

Part number	Interface
R191 553 800	SMA female - SMP-MAX female

## Standard Series Adapters

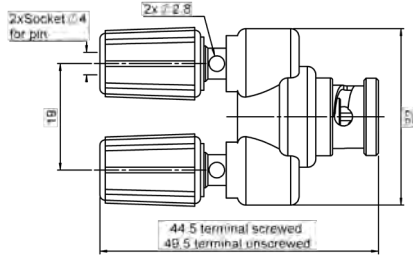

Part number	Interface
R191 453 000	2B4 female - BNC male

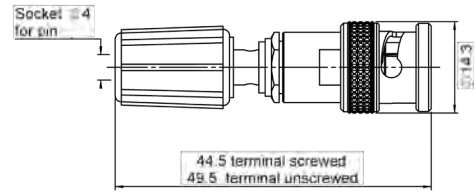

Part number	Interface
R191 454 000	2B4 female - BNC male

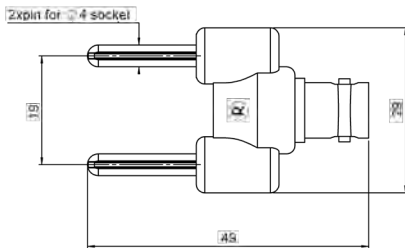

Part number	Interface
R191 455 000	2B4 male - BNC female

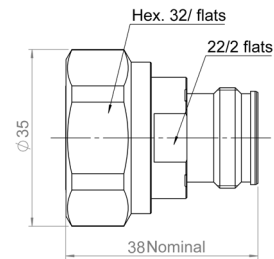

Part number	Interface
R191 592 007	4.3-10 female - 7/16 male

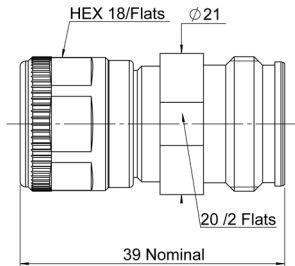

Part number	Interface
R191 591 007	4.3-10 female - N male

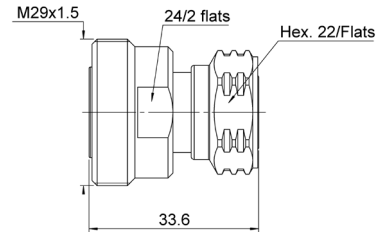

Part number	Interface
R191 592 017	4.3-10 male - 7/16 female

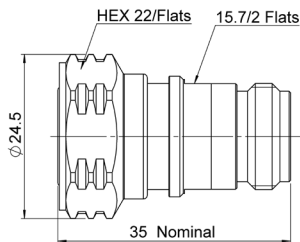

Part number	Interface
R191 591 017	4.3-10 male - N female

Standard Series Adapters

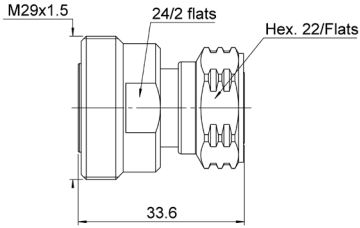

Part number	Interface
R191 592 017	7/16 female - 4.3-10 male

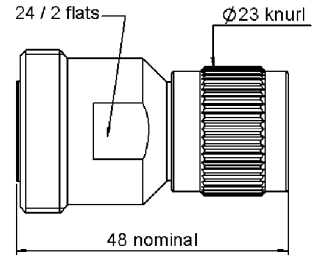

Part number	Interface
R191 908 000	7/16 female - HN male

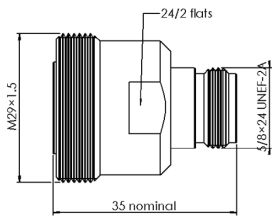

Part number	Interface
R191 723 000	7/16 female - N female

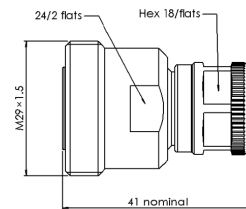

Part number	Interface
R191 720 000	7/16 female - N male

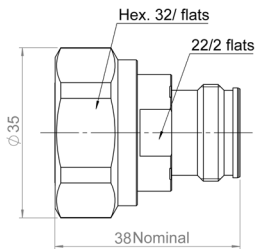

Part number	Interface
R191 592 007	7/16 male - 4.3-10 female

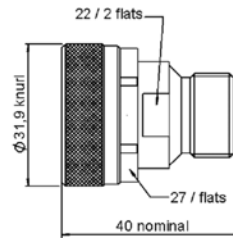

Part number	Interface
R191 907 000	7/16 male - HN female

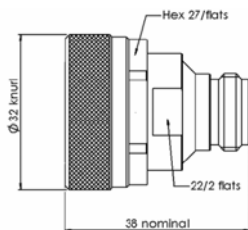

Part number	Interface
R191 722 000	7/16 male - N female

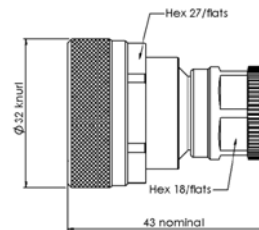

Part number	Interface
R191 721 000	7/16 male - N male

## Standard Series Adapters

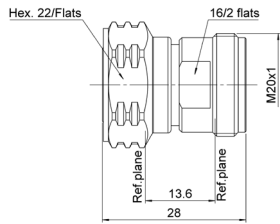

Part number	Interface
R191 598 007	4.3-10 male - 4.1-9.5 female

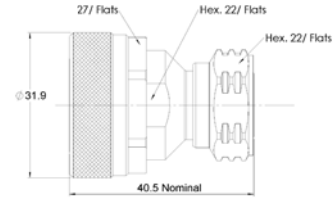

Part number	Interface
R191 592 027	4.3-10 male - 7/16 male

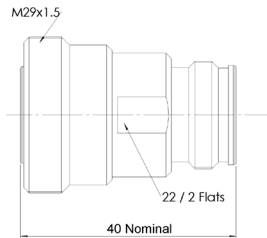

Part number	Interface
R191 592 037	4.3-10 male - 4.1-9.5 female

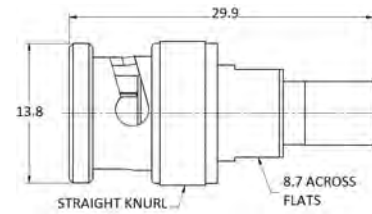

Part number	Interface
5405-1501-000	BNC male - SMB female

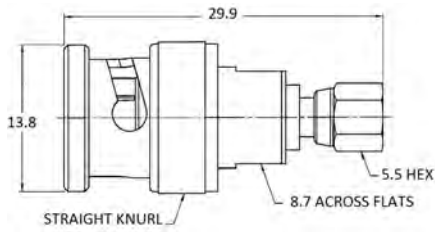

Part number	Interface
5403-1501-000	BNC male - SMC female

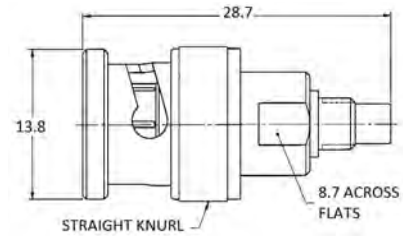

Part number	Interface
5402-1501-000	BNC male - SMC female

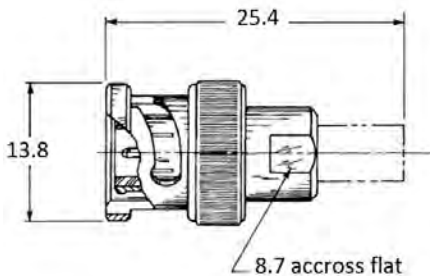

Part number	Interface
5404-1501-000	BNC male - SMB male

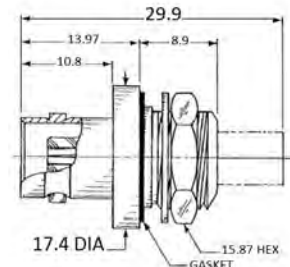

Part number	Interface
5510-1501-000	BNC male - SMB female

Standard Series Adapters

ADAPTERS 50Ω

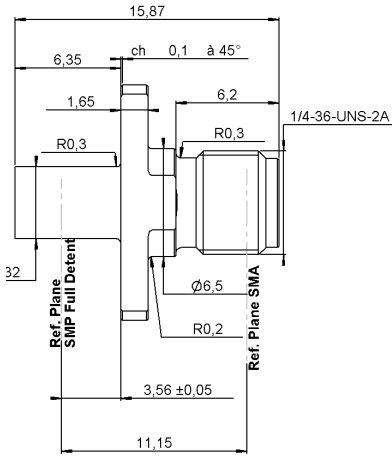

Part number	Interface
R191 843 429	SMA female - SMP male

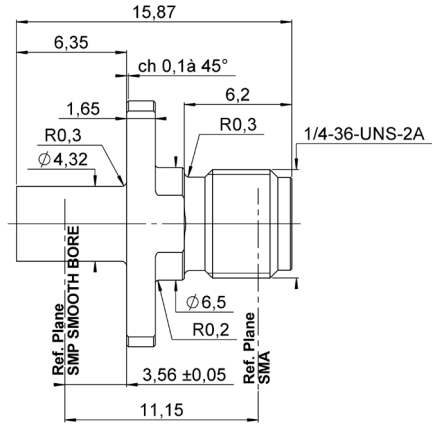

Part number	Interface
R191 843 409	SMA female - SMP male

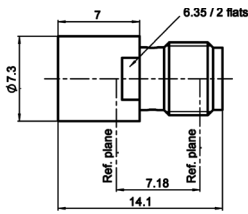

Part number	Interface
R191 353 711	BMA female - SMA female

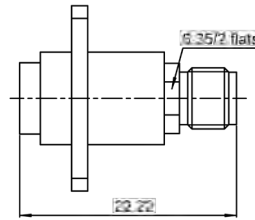

Part number	Interface	Panel drilling
R191 353 701	BMA female - SMA female	P12

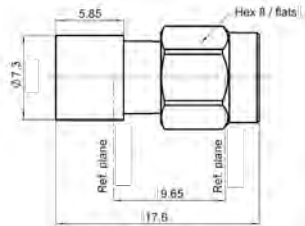

Part number	Interface
R191 351 701	BMA female - SMA male

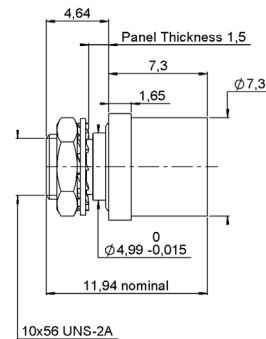

Part number	Interface
R191 815 110	BMA female - SMP male



## Standard Series Adapters

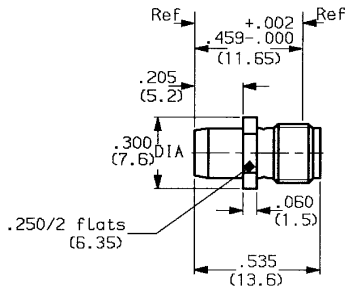

Part number	Interface
R191 352 001	BMA male - SMA female

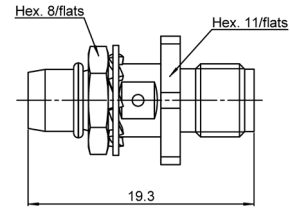

Part number	Interface	Panel drilling
R191 355 001	BMA male - SMA female	P03

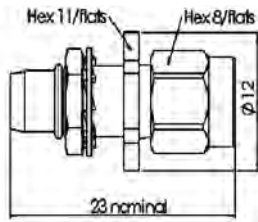

Part number	Interface	Panel drilling
R191 354 001	BMA male - SMA male	P03

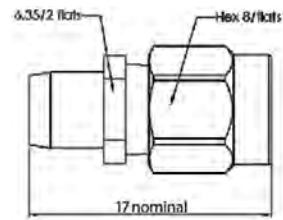

Part number	Interface
R191 350 001	BMA male - SMA male

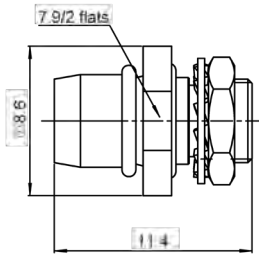

Part number	Interface	Panel drilling
R191 811 110	BMA male - SMP female	P13

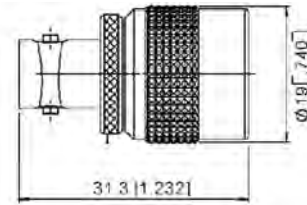

Part number	Interface
R191 429 000	BNC female - C male

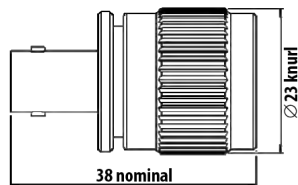

Part number	Interface
R191 449 000	BNC female - HN male

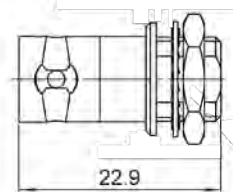

Part number	Interface	Panel drilling
R191 477 120	BNC female - MCX female	P10

Standard Series Adapters

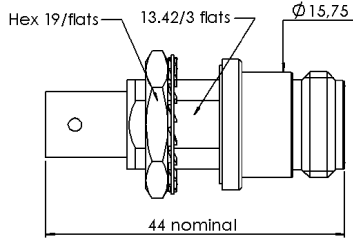

Part number	Interface	Panel drilling
R191 422 000	BNC female - N female	P11

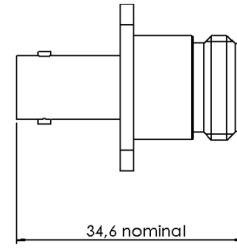

Part number	Interface	Panel drilling
R191 424 000	BNC female - N female	P01

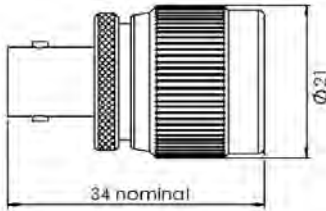

Part number	Interface
R191 421 000	BNC female - N male

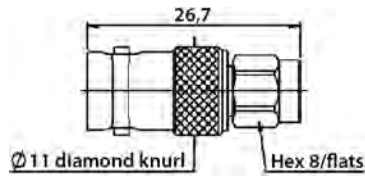

Part number	Interface
R191 303 000	BNC female - SMA male

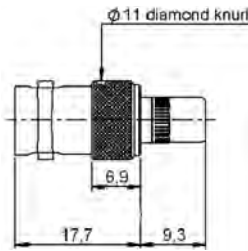

Part number	Interface
R191 215 000	BNC female - SMB female

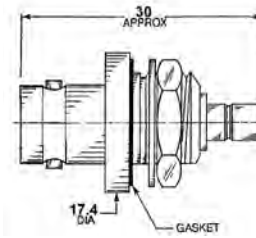

Part number	Interface	Panel drilling
5512-7501-000	BNC female - SMB male	P17

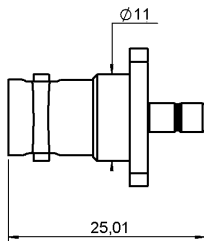

Part number	Interface	Panel drilling
R191 212 500	BNC female - SMB male	P14

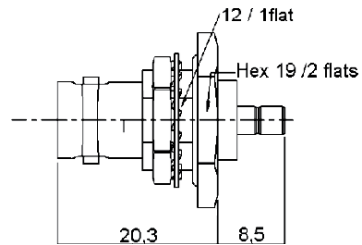

Part number	Interface	Panel drilling
R191 213 000	BNC female - SMB male	P04

## Standard Series Adapters

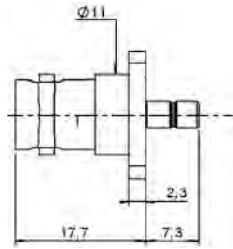

Part number	Interface	Panel drilling
R191 212 000	BNC female - SMB male	P02

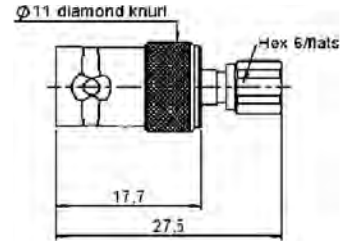

Part number	Interface
R191 123 000	BNC female - SMC female

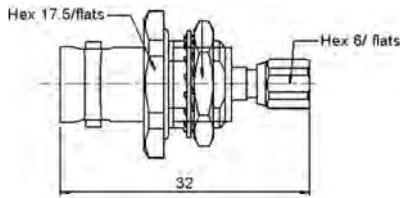

Part number	Interface	Panel drilling
R191 124 000	BNC female - SMC female	P06

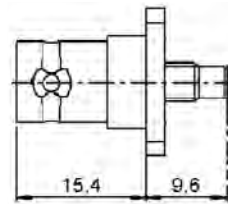

Part number	Interface	Panel drilling
R191 120 000	BNC female - SMC male	P02

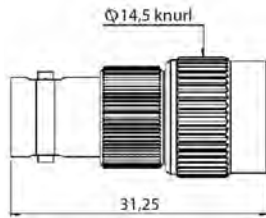

Part number	Interface
R191 405 000	BNC female - TNC male

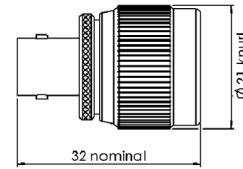

Part number	Interface
R191 447 000	BNC female - UHF male

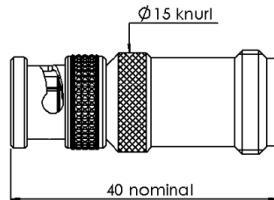

Part number	Interface
R191 419 000	BNC male - N female

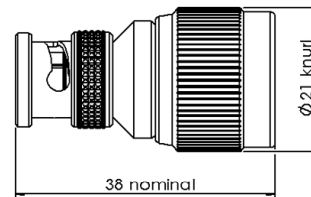

Part number	Interface
R191 417 000	BNC male - N male

Standard Series Adapters

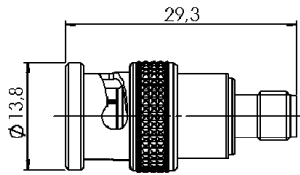

Part number	Interface
R191 305 000	BNC male - SMA female

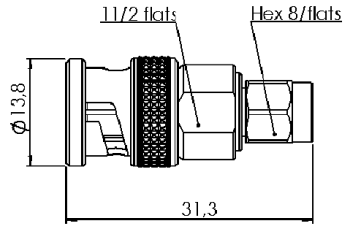

Part number	Interface
R191 301 000	BNC male - SMA male

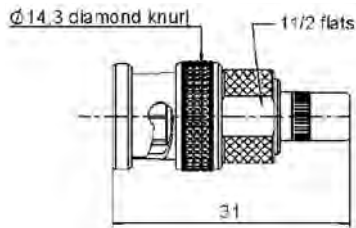

Part number	Interface
R191 214 000	BNC male - SMB female

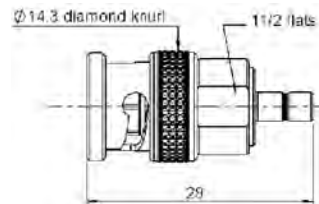

Part number	Interface
R191 209 000	BNC male - SMB male

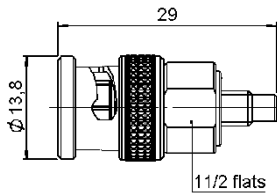

Part number	Interface
R191 117 000	BNC male - SMC male

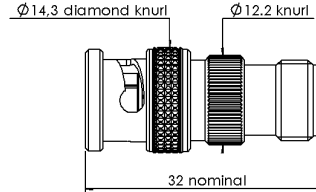

Part number	Interface
R191 403 000	BNC male - TNC female

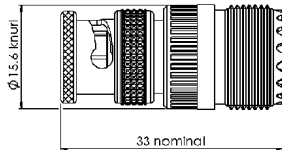

Part number	Interface
R191 445 000	BNC male - UHF female

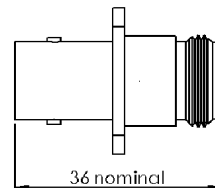

Part number	Interface	Panel drilling
R191 708 000	C female - N female	P01

## Standard Series Adapters

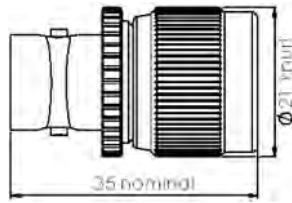

Part number	Interface
R191 703 000	C female - N male

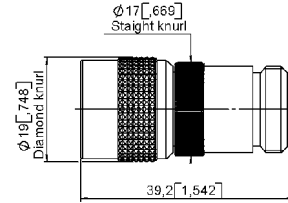

Part number	Interface
R191 705 000	C male - N female

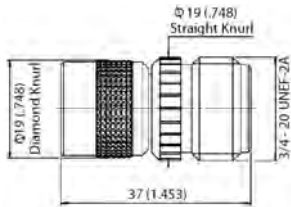

Part number	Interface
R191 933 000	C male - HN female

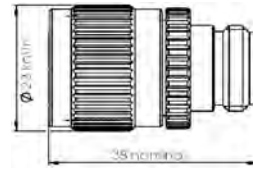

Part number	Interface
R191 737 000	HN male - N female

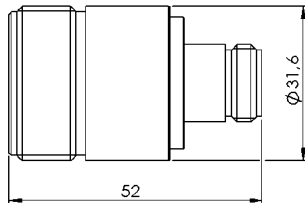

Part number	Interface
R191 741 000	LC female - N female

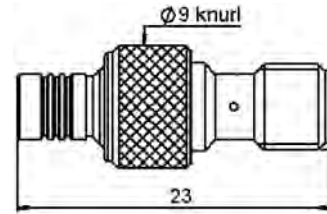

Part number	Interface
R191 388 000	MCX female - SMA female

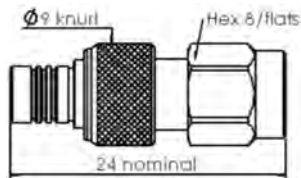

Part number	Interface
R191 386 000	MCX female - SMA male

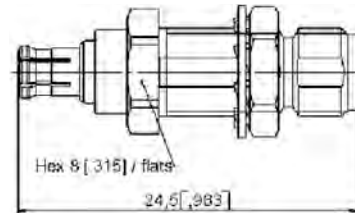

Part number	Interface	Panel drilling
R191 387 107	MCX male - SMA female	P07

Standard Series Adapters

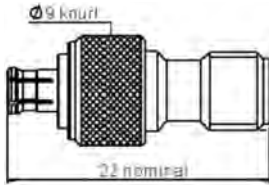

Part number	Interface
R191 387 000	MCX male - SMA female

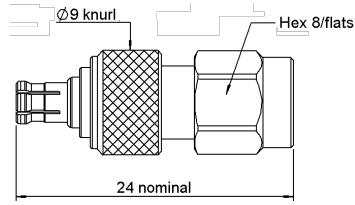

Part number	Interface
R191 385 000	MCX male - SMA male

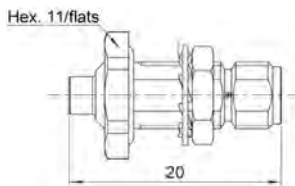

Part number	Interface	Panel drilling
R191 399 100	MMCX female - SMA female	P07

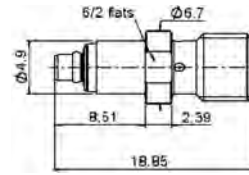

Part number	Interface
R191 398 020	MMCX male - SMA female

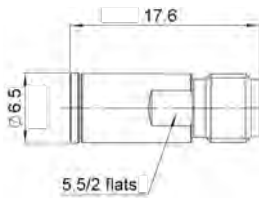

Part number	Interface
R191 389 400	MMBX female - SMA female

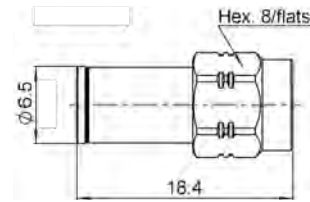

Part number	Interface
R191 389 300	MMBX female - SMA male

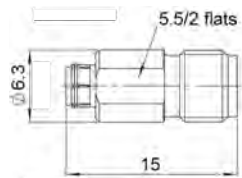

Part number	Interface
R191 389 200	MMBX male - SMA female

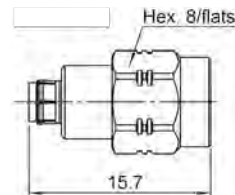

Part number	Interface
R191 389 100	MMBX male - SMA male

Standard Series Adapters

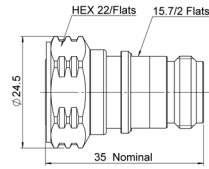

Part number	Interface
R191 591 017	N female- 4.3-10 male

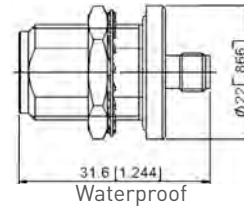

Part number	Interface	Panel drilling
R191 334 000	N female - SMA female	P05

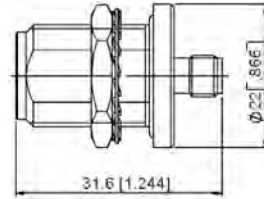

Part number	Interface	Panel drilling
R191 332 000	N female - SMA female	P05

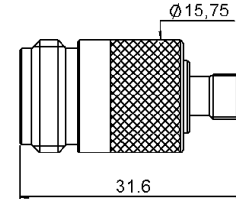

Part number	Interface
R191 331 000	N female - SMA female

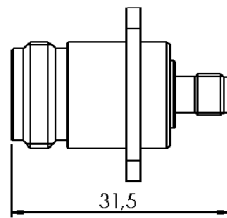

Part number	Interface	Panel drilling
R191 381 000	N female - SMA female	P01

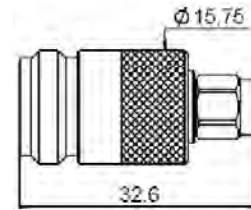

Part number	Interface
R191 327 000	N female - SMA male

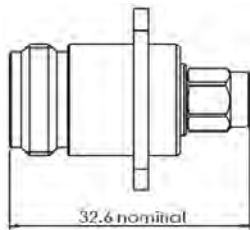

Part number	Interface	Panel drilling
R191 377 000	N female - SMA male	P01

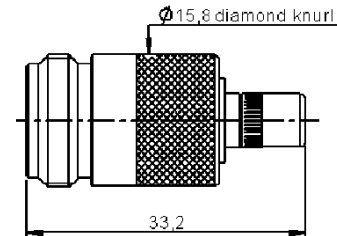

Part number	Interface
R191 239 000	N female - SMB female

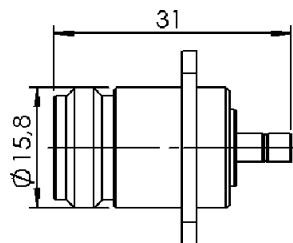

Part number	Interface	Panel drilling
R191 236 000	N female - SMB male	P01

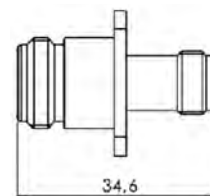

Part number	Interface	Panel drilling
R191 514 000	N female - TNC female	P01

Standard Series Adapters

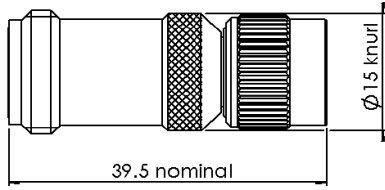

Part number	Interface
R191 511 000	N female - TNC male

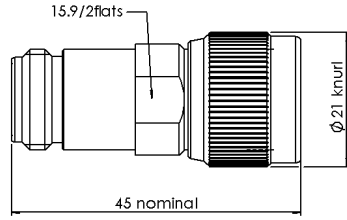

Part number	Interface
R191 733 000	N female - UHF male

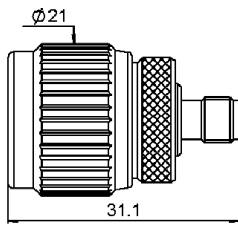

Part number	Interface
R191 329 000	N male - SMA female

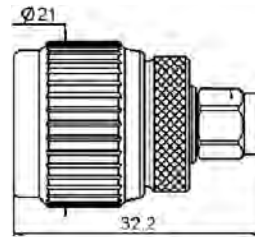

Part number	Interface
R191 325 000	N male - SMA male

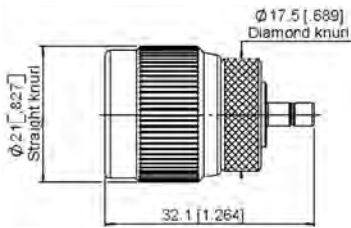

Part number	Interface
R191 233 000	N male - SMB male

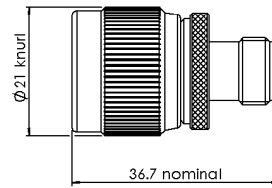

Part number	Interface
R191 513 000	N male - TNC female

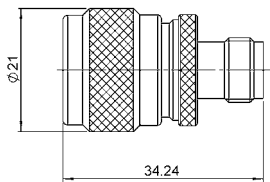

Part number	Interface
R191 513 050	N male - TNC female

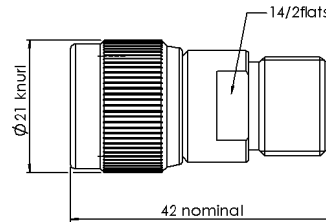

Part number	Interface
R191 731 000	N male - UHF female



Standard Series Adapters

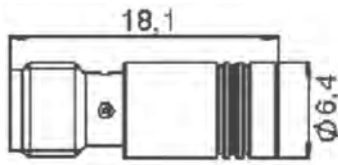

Part number	Interface
R191 203 007	SMA female - SMB female

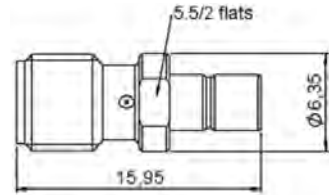

Part number	Interface
R191 201 007	SMA female - SMB male

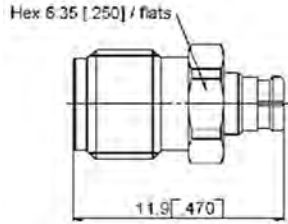

Part number	Interface
R191 844 002	SMA female - SMP female

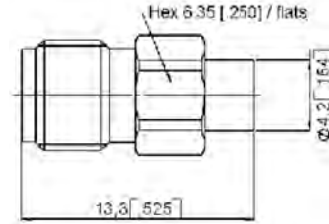

Part number	Interface
R191 843 001	SMA female - SMP male

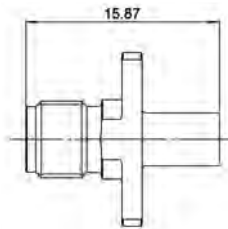

SMP full detent

Part number	Interface	Panel drilling
R191 843 421	SMA female - SMP male	P15

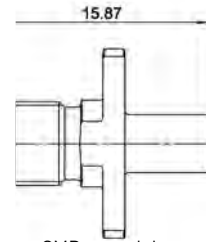

SMP smooth bore

Part number	Interface	Panel drilling
R191 843 401	SMA female - SMP male	P15

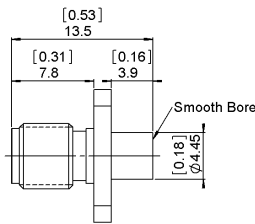

Part number	Interface	Panel drilling
5964-9513-001	SMA female - SMPM male	P15

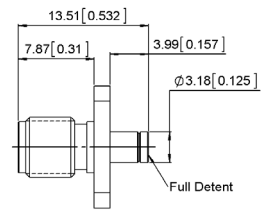

Part number	Interface	Panel drilling
5965-9513-000	SMA female - SMPM male	P15

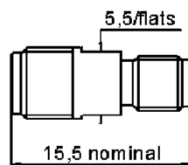

Part number	Interface
R191 349 000	SMA female - SSMA female

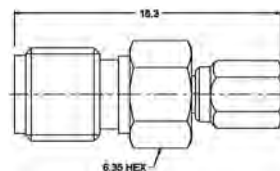

Part number	Interface
5945-9503-000	SMA female - SSMC female

Standard Series Adapters

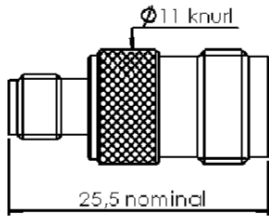

Part number	Interface
R191 315 000	SMA female - TNC female

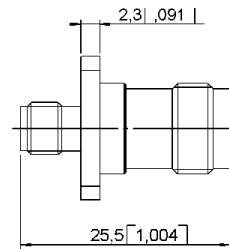

Part number	Interface	Panel drilling
R191 365 000	SMA female - TNC female	P02

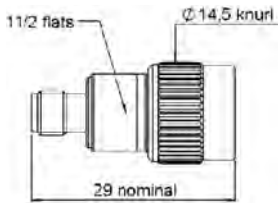

Part number	Interface
R191 313 000	SMA female - TNC male

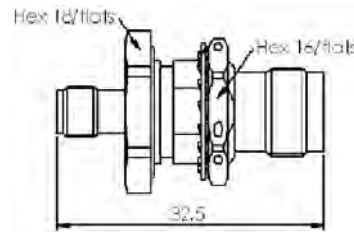

Part number	Interface	Panel drilling
R191 314 700	SMA female - TNC18 female	P04

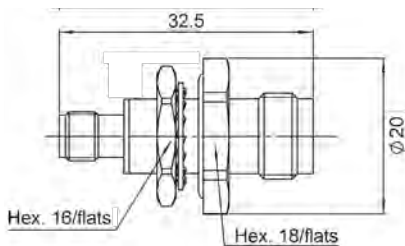

Part number	Interface	Panel drilling
R191 314 730	SMA female - TNC18 female	P08

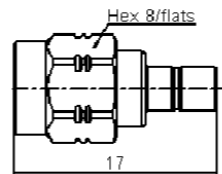

Part number	Interface
R191 200 007	SMA male - SMB male

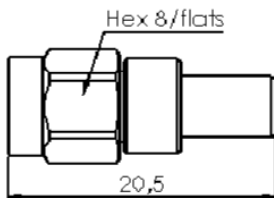

Part number	Interface
R191 374 000	SMA male - SMC female

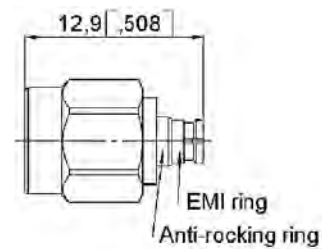

Part number	Interface
R191 842 002	SMA male - SMP female

## Standard Series Adapters

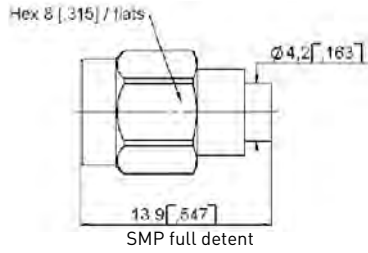

Part number	Interface
R191 841 001	SMA male - SMP male

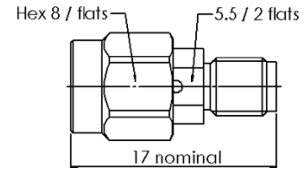

Part number	Interface
R191 347 000	SMA male - SSMA female

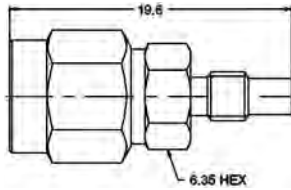

Part number	Interface
5938-1503-000	SMA male - SSMC male

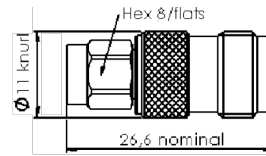

Part number	Interface
R191 311 000	SMA male - TNC female

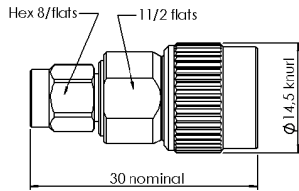

Part number	Interface
R191 309 000	SMA male - TNC male

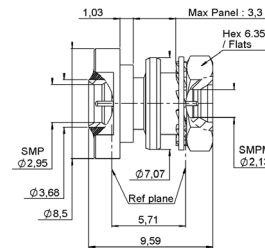

Part number	Interface
R191 570 100	SMP male - SMPM male

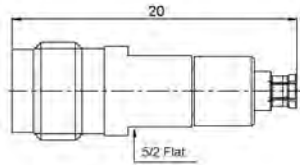

Part number	Interface
R191 565 000	SMPM Female - 2.4mm Female

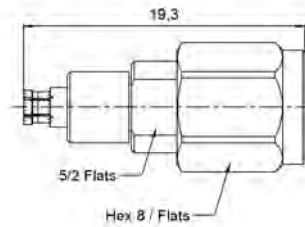

Part number	Interface
R191 563 000	SMPM Female - 2.4mm Male

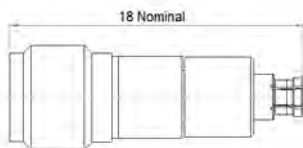

Part number	Interface
R191 959 000	SMPM female - 2.9mm female

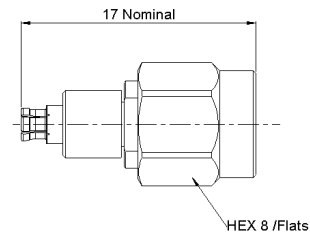

Part number	Interface
R191 957 000	SMPM female - 2.9mm male

Standard Series Adapters

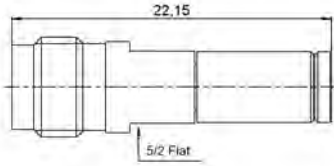

Part number	Interface
R191 564 000	SMPM male - 2.4mm female

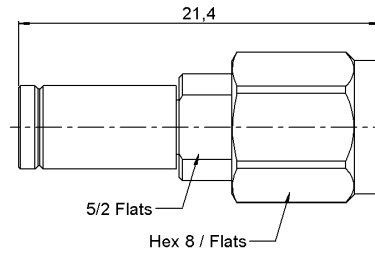

Part number	Interface
R191 562 000	SMPM male - 2.4mm male

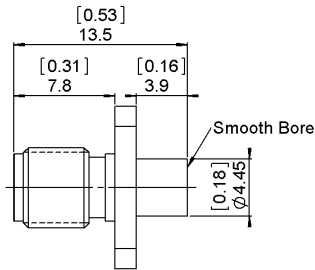

Part number	Interface
5964-9513-001	SMPM male - SMA female

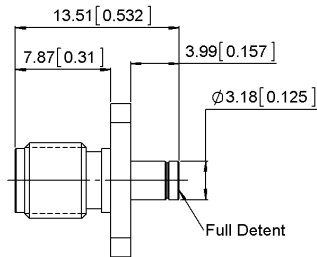

Part number	Interface
5965-9513-000	SMPM male - SMA female

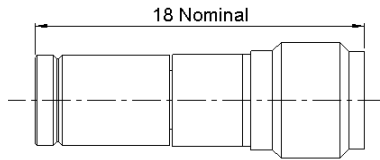

Part number	Interface
R191 958 000	SMPM male - SMA 2.9 female

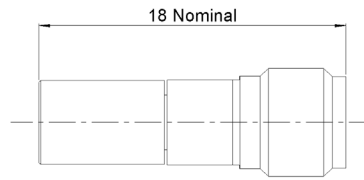

Part number	Interface
R191 958 020	SMPM male - SMA 2.9 male

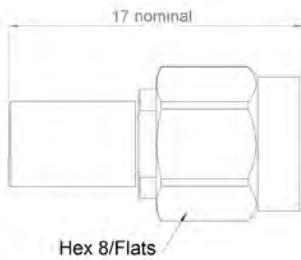

Part number	Interface
R191 956 020	SMPM male - SMA 2.9 male

## Panel Drilling

P01

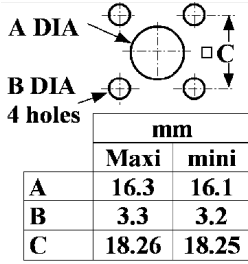

P02

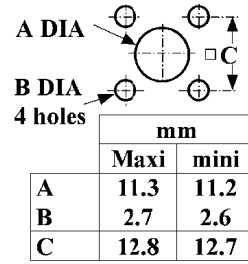

P03

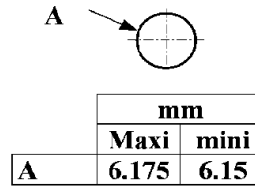

P04

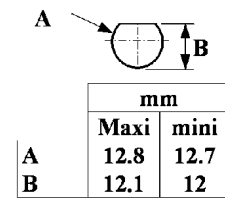

P05

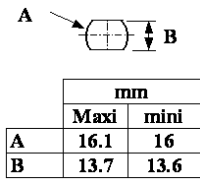

P06

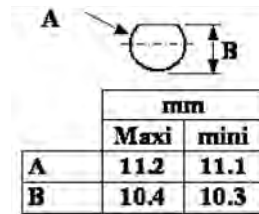

P07

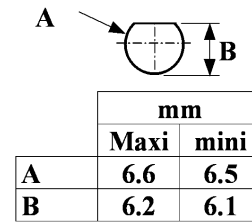

P08

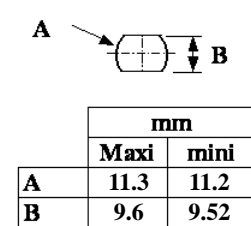

P10

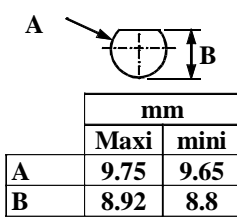

P11

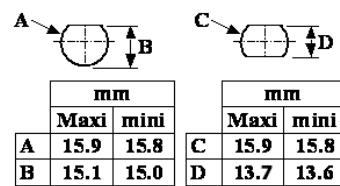

P12

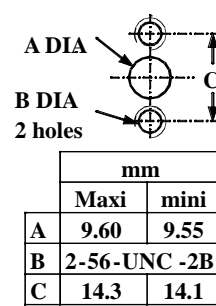

P13

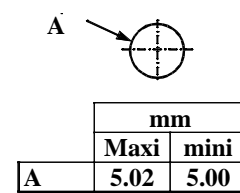

P14

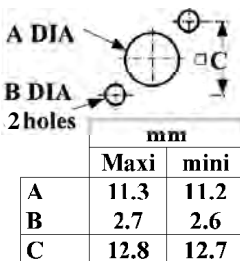

P15

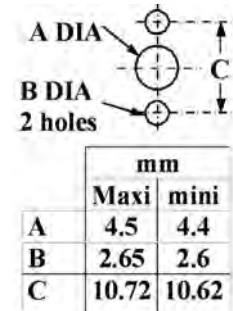

P16

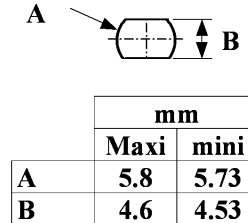

P17

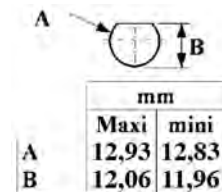

NOTE



# NOTE





## TOOLING & ACCESSORIES

R280/R282



**Contents****TOOLING**

Joule effect soldering devices .....	17-4
Stripping tools .....	17-4 and 17-7
Point gauges .....	17-4
Soldering .....	17-5
Installation tools .....	17-5 to 17-6
Cassettes .....	17-7
Kits for semi-rigid .....	17-8 to 17-10
Kit for microporous semi-rigid cables .....	17-11
Kits for flexible cables .....	17-11
Crimp tools .....	17-12 to 17-13
Torque wrench .....	17-14
Insertion and extraction tools .....	17-15 to 17-17

**ACCESSORIES**

Sliding contacts .....	17-17
Glass beads and EMI gaskets .....	17-18
Insulated washers .....	17-19
Solder tag .....	17-20
Panel sealing gaskets .....	17-20
Cable panel feedthrough .....	17-20
Cable terminations .....	17-21
Heat-shrink sleeves .....	17-22
Cable boots .....	17-22
Panel drilling .....	17-23

**SECTION 17 TABLE OF CONTENTS**

*Joule Effect Soldering Devices, Tools and Pointer Gauge*

**JOULE EFFECT SOLDERING DEVICES**

Compliant with European standards n° 89/336/CEE and 73/23/CEE (electromagnetic compatibility and low voltage). It allows soldering to:

- Center contacts and bodies to semi-rigid cables
- Center contacts to flexible cables
- Solder pot receptacles



Photo 1



Photo 2

Part number	Photo	Power	Delivered with
R282 800 000	1	80 Watts	Pliers + electrode: R282 800 020
R282 800 001	2	200 Watts	Pliers: R282 800 011 Electrode: R282 800 022

**STRIPPING TOOL FOR SEMI-RIGID CABLE**

This easy to use tool removes the cable's outer conductor and dielectric leaving the center conductor stripped to the proper length. It is supplied with a removal blade which can be ordered separately whenever required. Please specify P/N R282 055 000 when ordering the replacement blade, including adjustment gauge and male hex key.



Cable group	Cable group dia.	Part number
RG405	.085"	R282 051 000
RG402	.141"	R282 053 000
RG401	.250"	R282 054 000

**POINTER GAUGE FOR SEMI-RIGID CABLE**

Specially designed for sharpening the end of the cable's center conductor, this sharpening tool-gauge is supplied with a removable blade which can be ordered separately whenever required.



Cable group	Cable group dia.	Part number	Stripping length setting	Replacement blade
RG402	.141"	R282 066 000	2.17 (.085)	R282 056 118
		R282 067 000	3.17 (.125)	
RG405	.085"	R282 062 010	1.30 (.051)	R282 056 085
		R282 063 000	3.17 (.125)	

Soldering and Installation Tools

**SOLDERING FIXTURE (JIG)**

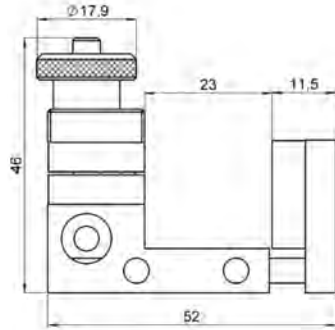

Cable group	Cable group dia.	Part number
RG405 / RG402 / RG401	.085"/.141"/.250"	R282 740 000
RG402 / RG401	.141"/.250"/.350"	R282 740 030

**DRILLING TOOL FOR GLASS BEAD MOUNTING**



Part number	Dia. (mm)
R282 080 000	1.98

Must be used with machine tool to obtain the required concentricity and dimensions.

**SCREW TAP FOR HERMETIC RECEPTACLE SMA, BMA, ...**



Part number	Dimension
R282 082 000	1/4 36 UNS 2B

**INSTALLATION TOOL FOR SMA SCREW-ON FEMALE RECEPTACLES**

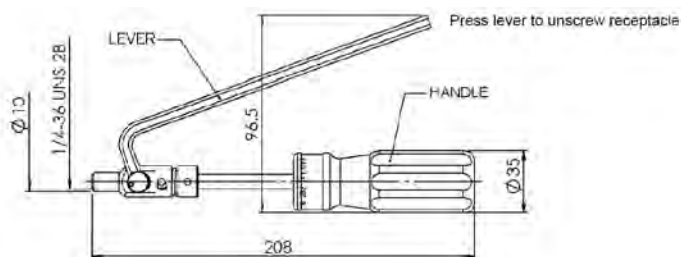

Part number	Coupling torque (N/cm)
R282 341 012	280
R282 341 010	190

Installation Tools

INSTALLATION TOOL FOR BMA MALE RECEPTACLES R128 639 XXX

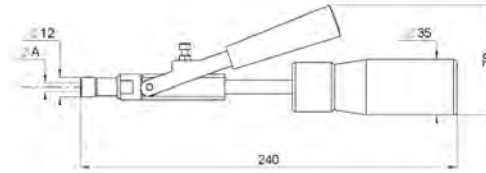

Part number	Coupling torque (N/cm)	Dimension A mm (inch)
R282 340 000	280	5.3 (.209)

TORQUE SCREWDRIVER FOR SMP THREAD-IN RECEPTACLES

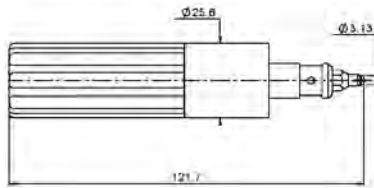
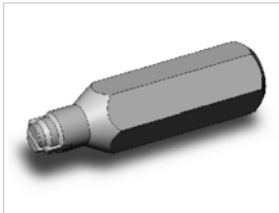

Fig. 1

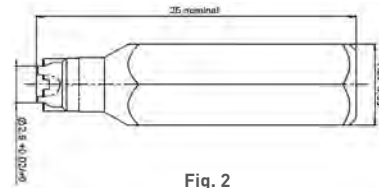

Fig. 2

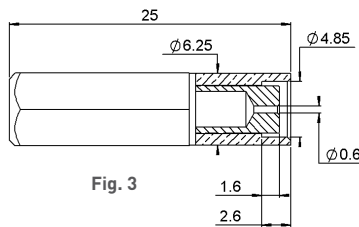

Fig. 3

With bit (fig.1)	Part number	Note	Coupling torque	
-	Bit only (fig.2)			
R282 339 001	R282 360 001	-	7.96 lbf.inch (90cmN)	
-	R282 360 002	-		
-	R282 360 003	-		
R282 339 005	-	R282 360 004	For SMP-LOCK™ no hermetic	5.3 lbf.inch (60cmN)
R282 339 004	-	R282 360 004	For hermetic SMP-LOCK™	

TIGHTENING TOOL



Part number
R282 202 000

A new universal plier helps facilitate the tightening of coupling nuts. The removable inserts are made of plastic in order to avoid damage on the knurling (for ≈ 130 Ncm).

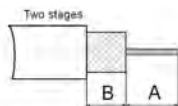

Stripping Tools

**STRIPPING TOOL R299 520 000 FOR CABLE DIA. 2.5 TO 8mm (RG58, RG59, RG62) (includes standard cassette R299 522 000)**

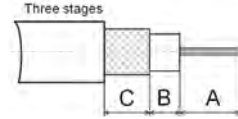

1) Dimension A in accordance with the plug stripping dimensions (not defined by the tool)

Part number	Designation	Stripping dimension
R299 520 000	Fixed-blade coaxial cable stripping tool for cable dia. 2.5 to 8.0 mm [.1" to .315"] Blades can be adjusted to precise cutting depths. Interchangeable blade cassette holders eliminate need to readjust blades	
R299 522 000	Adjustable blade, 2 or 3 stages	adjustable
R299 521 011	Replacement blade red, 2 stages	B = 6mm
R299 521 012	Replacement blade green, 3 stages	B = 5.1mm C = 7.1mm
R299 521 013	Replacement blade blue, 2 stages	B = 6.5mm
R299 521 014	Replacement blade yellow, 2 stages	B = 12mm
R299 521 015	Replacement blade grey, 2 stages	B = 3.9mm
R299 521 017	Replacement blade brown, 3 stages	B = 3.5mm C = 7.5mm

**STRIPPING TOOL R299 550 000 FOR CABLE DIA. 2.5 TO 11mm**



Part number	Designation
R299 550 000	Cable stripping range 2.5 to 11mm [.0984" to .4331"] Spring Tension - Squeeze to Open, Insert Cable & Rotate Around Jacket Delivers Smooth Consistent Strips. 9 Position Adjustable Depth Blade

**KIT R299 510 010: STRIPPING TOOL FOR 2.5 TO 7.6mm DIA. FLEXIBLE CABLES (without cassette)**

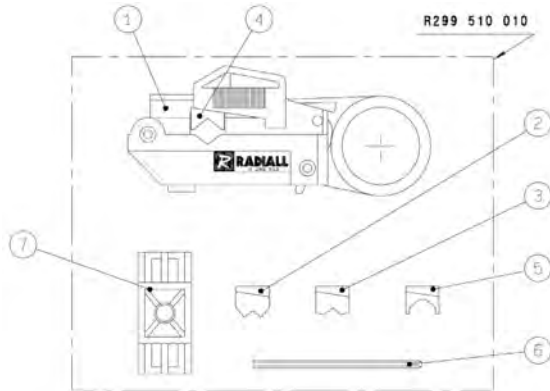
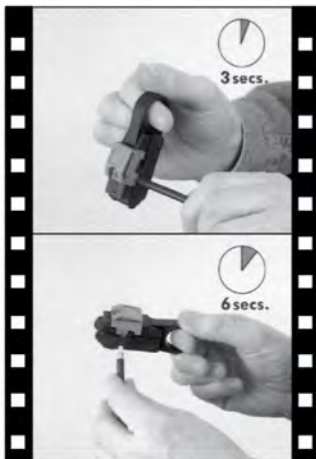

Part number	Designation
R299 510 010	STRIPPING TOOL 1 - Stripping tool 2 - White V guide for dia ext. cable 2.5 to 3 mm 3 - Red V guide for dia ext. cable 3 to 5 mm 4 - Blue V guide for dia ext. cable 5 to 6.4 mm 5 - Yellow V guide for dia ext. cable 6.4 to 7.6 mm 6 - Wrench 7 - Gauge

**CASSETTES FOR R299 510 010**

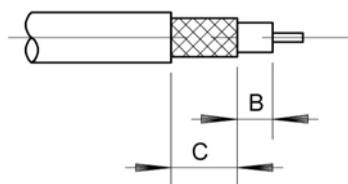
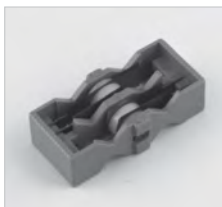

Part number	Designation	Length B (mm)	Length C (mm)
R299 511 013	Orange stripping cassette	3.5	6.5
R299 511 016	White stripping cassette	1.5	6.3
R299 511 011	Green stripping cassette	6.0	6.9
R299 511 012	Yellow stripping cassette	2.0	8.0

Kits for Semi-Rigid Cables

R282 102 000: Bending kit



N°	Part number	Designation	Old cross reference	Mark
1	R282 750 000	Bending	730 11 000	[09]
2	R282 751 050	Bending gauge .085"	730 11 040	[02]
3	R282 751 051	Bending gauge .085"	730 11 030	[01]
4	R282 751 070	Bending gauge .141"	730 11 060	[04]
5	R282 751 080	Bending gauge .250"	730 11 070	[05]
6	R282 751 071	Bending gauge .141"	730 11 050	[03]

KIT: Stripping + sharpening for semi-rigid cables



R282 114 125: Stripping 3.17 (.125) + sharpening for .085" semi-rigid cables

N°	Part number	Designation
1	R282 051 000	Stripping tool .085"
2	R282 055 000	Replacement stripping blade
3	R282 864 110	Blade installation gauge .085"
4	R282 344 150	Hex 1.5 (.059)
5	R282 063 000	Sharpening and length-setting tool 3.17 (.125") long on .085"
6	R282 056 085	Replacement sharpening blade
7	R282 344 127	Hex 1.27 (.05)

## Kits for Semi-Rigid Cables

**R282 114 162: Stripping 2.17 (.085) + sharpening for .141" semi-rigid cables**

N°	Part number	Designation
1	R282 053 000	Stripping tool .141"
2	R282 055 000	Replacement stripping blade
3	R282 864 120	Blade installation gauge .141"
4	R282 344 150	Hex 1.5 (.059)
5	R282 066 000	Sharpening and length-setting tool 2.17 (.085") long on .141"
6	R282 056 118	Replacement sharpening blade
7	R282 344 127	Hex 1.27 (.05)

**R282 114 165: Stripping 3.17 (.125) + sharpening for .141" semi-rigid cables**

N°	Part number	Designation
1	R282 053 000	Stripping tool .141"
2	R282 055 000	Replacement stripping blade
3	R282 864 120	Blade installation gauge .141"
4	R282 344 150	Hex 1.5 (.059)
5	R282 067 000	Sharpening and length-setting tool 3.17 (.125") long on .141"
6	R282 056 118	Replacement sharpening blade
7	R282 344 127	Hex 1.27 (.05)

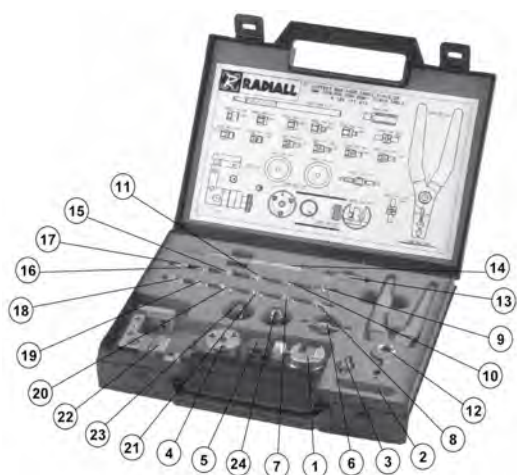
**R282 120 010: SMA solder kit (suitable for commercial and standard SMA)**

N°	Part number	Designation	Mark
1	R282 059 100	Cable holder	-
2	R282 862 060	Solder gauge (cab .085": mark 61, cab .141": mark 62)	-
3	R282 744 200	Soldering locator tool for right angle SMA	(84)
4	R282 053 100	Stripping tool	-
5	R282 066 100	Trimmer	-
6	R282 744 220	Soldering locator tool for center contact	-
7	R282 744 060	Soldering locator tool for male SMA cable .085"	(85)
8	R282 744 062	Soldering locator tool for male SMA B cable .085"	(78)
9	R282 744 201	Soldering locator tool for right angle SMA B	(88)
10	R282 744 010	Soldering locator tool for female cable .085"	(80)
11	R282 744 011	Soldering locator tool for female cable .141"	(86)
12	R282 200 000	Retaining ring pliers	-
13	R282 760 000	Retaining insert tool	-
14	R282 915 010	Dielectric recess tool	-
15	R282 914 010	Dielectric recess gauge for female	(92)
16	R282 857 010	Control gauge for female	(81)
17	R282 744 100	Soldering locator tool for male	(82)
18	R282 857 000	Control gauge for male	(83)
19	R282 914 000	Dielectric recess gauge for male	(93)
20	R282 744 063	Soldering locator tool for male SMA B cable .141"	(77)
21	R282 744 061	Soldering locator tool for male SMA cable .141"	(87)
22	R282 740 000	Soldering fixture	-
23	R282 730 040	Dielectric insert tool + dielect plunger for female	-
24	R282 730 043	Dielectric insert tool + dielect plunger for male	-



## Kits for Semi-Rigid Cables

## R282 122 010: TNC 18 Ghz solder kit

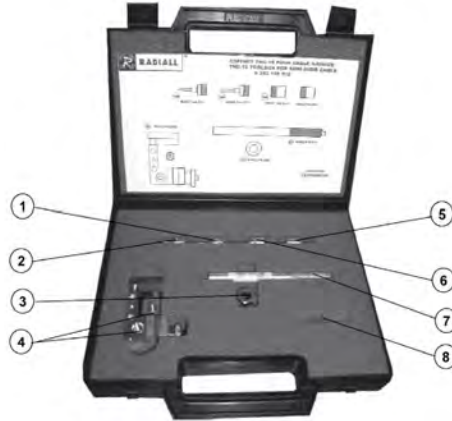

N°	Part number	Designation	Mark
1	R282 744 271	Soldering locator tool for male	[128]
2	R282 744 270	Soldering locator tool for female	[129]
3	R282 370 020	Locking tool	[132]
4	R282 740 000	Soldering fixture	[10]
5	R282 744 000	Soldering locator tool for .085" cable	-
6	R282 744 003	Soldering locator tool for .141" cable	[133]
7	R282 915 020	Dielectric recess tool	[97]
8	R282 862 100	Solder gauge	[63]

## R282 125 010: Solder kit for N connectors

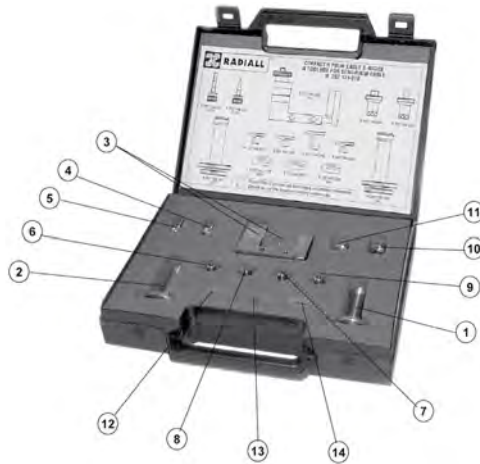

N°	Part number	Designation	Old cross reference	Mark
1	R282 730 160	.250" dielectric insertion tool + plunger for N jacks	730 25 007	[36]
2	R282 730 161	.141" dielectric insertion tool + plunger for N jacks	730 25 008	[37]
3	R282 740 030	Soldering fixture	730 15 022	[11]
4	R282 744 260	N soldering fixture for female centre contact	730 40 005	[126]
5	R282 744 261	N soldering fixture for male centre contact	730 40 006	[127]
6	R282 744 300	N soldering fixture for cable .085"	-	-
7	R282 744 310	N soldering fixture for cable .141"	-	-
8	R282 744 320	N soldering fixture for cable .141"	-	-
9	R282 744 330	N soldering fixture for cable .250"	-	-
10	R282 744 340	Soldering fixture for N plug cable .141"	-	-
11	R282 744 350	Soldering fixture for N plug cable .250"	-	-
12	R282 862 070	Solder gauge thickness 0.35 (.0138")	730 15 170	[62]
13	R282 862 080	Solder gauge thickness 0.45 (.0177")	-	-
14	R282 862 090	Solder gauge thickness 0.70 (.0276")	730 15 180	[64]
15	R282 915 030	Dielectric recess tool for cable .141"	-	-
16	R282 915 040	Dielectric recess tool for cable .250"	-	-



Kit for Microporous Semi-Rigid Cables

R282 120 220: Solder kit for SMA 2.9

No.	REFERENCE	DESIGNATION
1	R282 323 000	Torque wrench
2	R282 061 030	Pointer gauge for cable .085 MP
3	R282 067 030	Pointer gauge for cable .141 MP
4	R282 744 190	Soldering positioner cable .085
5	R282 744 192	Soldering positioner cable .141
6	R282 740 000	Soldering assembly jig
7	R282 053 030	Stripping tool cable .141 MP
8	731 22 034A	Stripping tool cable .085 MP
9	R282 059 010	Cable holder

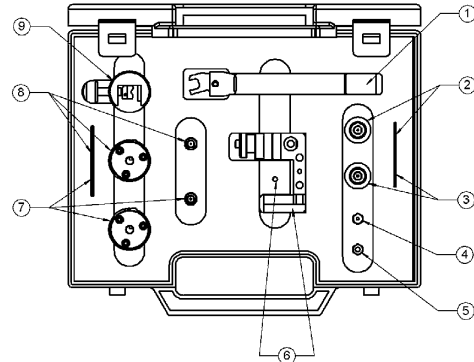

Kits for Flexible Cables

R282 124 100:  
Stripping + crimping  
kit for cables 10+11/50/s+d



N°	Part number	Designation
1	R282 231 000	Crimping tool 
2	R282 078 200	Green stripping cassette 
3	R282 078 220	Green stripping cassette
4	R282 078 500	Adjustment bit
5	R282 078 000	Universal tool body a - Red V guide for dia ext. cable 7 to 9 mm b - Blue V guide for dia ext. cable 9 to 11.5 mm c - Yellow V guide for dia ext. cable 11.5 to 14 mm d - Two interior supports e - Universal tool body f - Adjustment bit (Identical R282 078 500) g - Wrench

Inside the box, every part number can be ordered separately.

Crimp Tools



MIL CRIMP TOOL (M22520/5-01) R282 293 000 (dies not included)

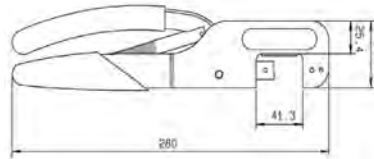

DIES FOR R282 293 000



Cable group	Cable group dia.	Part number			
		Dieset only	Tool complete with dies		
RG178 / RG196 / RD178 / RG174 / RG316 / RG179	2/50/S+D - 2.6/50+75/S	R282 235 003	TA-0105	3.25 (.128)	2.67 (.105)
RG58 / RG141 / RG142 / RG223 / RG400	5/50/S - 5/50/D	R282 235 011	-	5.41 (.213)	1.73 (.068)
KX6-RG62	6/75 + 93	R282 235 013	-	6.48 (.255)	1.73 (.068)

CRIMP TOOL (dies included)



Fig. 1



Fig. 2



Fig. 3

Part number	Fig.	Cable group	Cable group dia.	Color of handles			
R282 211 000	1	.046"OD / .048"OD - RG178 / RG196 / .075"OD RG174 / RG316 / RF179	1/50+75 - 2/50/S+75 - 2.6/50/S+75	Red	4.52 (.178)	3.25 (.128)	2.67 (.105)
R282 223 000		RG122 / RG58 / RG62	4/50+75 - 5/50 - 6/75+93	Orange	6.48 (.255)	5.41 (.213)	1.73 (.068)
R282 227 000	3	RG6	8/75+95	Blue	8.23 (.324)		1.73 (.068)
R282 231 000	2	RG393 / RG214	10/50/D - 10.3/50/S - 11/50/D	Yellow	10.54 (.415)	2.54 (.1)	
R282 232 000	3	RD179 / mini RG159 / RG6	4.0/75/D-7/75D	Blue	6.7(.236)	5.4(.213)	Square 1.1(.043)
R282 234 000		RG59	6/75D	Black	6.98(.275)	6.48(.255)	Square 1.15(.0452)
R282 271 000		RG178 / RG174 / RG316 / RD316 / RG179 / RD179	2/50+75 - 2.6/50+75/S+D	Black	3.84 (.131)	3.25 (.128)	0.72* (.028)

\* Square crimping die.

Crimp Tools

**BNC TOOLKITS**

Part number	Designation
R282 124 050 (50Ω)	1x R282 223 000 Crimp tool for cable diameter 5 or 6 mm. Hex.: 1.73/5.41/6.48 15x R141 082 161 BNC male, straight, crimp for RG58 1x R299 520 000 Strip tool 1x R299 521 017 Replacement blade brown, 3 step for RG58, RG59

Part number	Designation
R282 124 075 (75Ω)	1x R282 223 000 Crimp tool for cable diameter 5 or 6 mm. Hex.: 1.73/5.41/6.48 15x R142 085 161 BNC male, straight, crimp for RG59 1x R299 520 000 Strip tool 1x R299 521 017 Replacement blade brown, 3 step for RG58, RG59



**CRIMP TOOL R282 281 000 FOR CENTER CONTACTS**

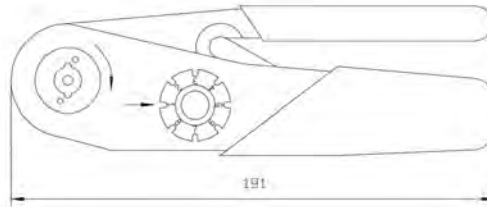

**LOCATOR TOOL FOR CENTER CONTACT CRIMP TOOL R282 281 000**



Part number	Note
R282 967 030	For pin contact for socket contact
R282 983 000	

Torque Wrench

**TORQUE WRENCH 4 TO 10mm**

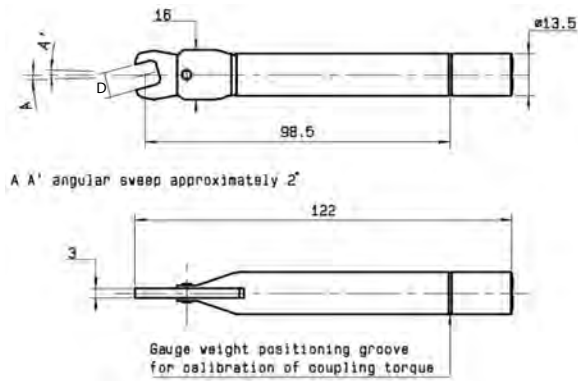

Part number	Across flats D (mm)	Coupling torque (N.cm)
R282 318 000	6 (.236)	30
R282 319 000	6.35 (.250)	60 to 80
R282 320 000	8 (.315)	80 to 120
R282 320 030		60
R282 320 031		70
R282 323 000	6.5 (.256)	80 to 120
TA-0456	8 (.315)	395 (35 lbf-in)
TA-0398	5.5 (.218)	34 (48 oz-in)
TA-0432	4.0 (.156)	21 (30 oz-in)
TA-0436	5.5 (.218)	68 (96 oz-in)

**TORQUE WRENCH 10 TO 21 MM**

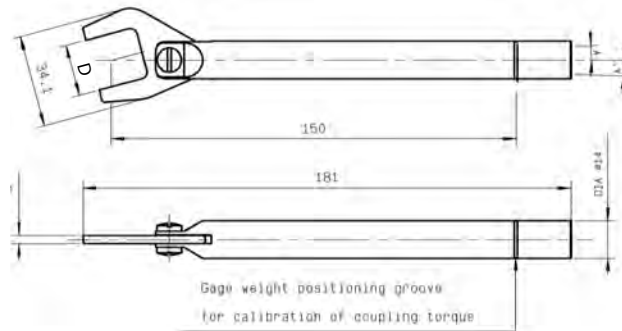

Part number	Across flats D (mm)	Coupling torque (N.cm)
R282 300 000	14 (.550)	265
R282 303 020	18 (.710)	170
R282 303 000	19 (.748)	160
R282 303 010		130
R282 303 230	21 (.827)	400

**TORQUE WRENCH 32 MM**

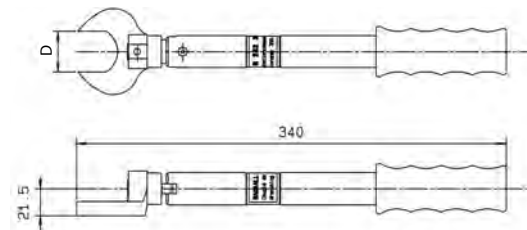

Part number	Across flats D (mm)	Coupling torque (N.cm)
R282 303 500	32 (1.260)	3500

Insertion and Extraction Tools

EXTRACTION TOOLS FOR BMA & COAXIPACK 2

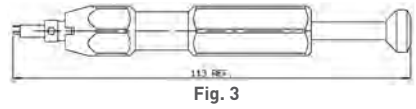
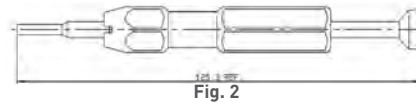
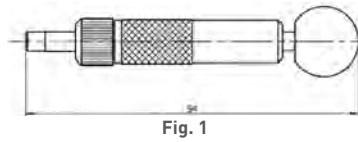

Part number	Fig.	Use	Note
R282 918 000	1	-	For removing BMA floating plug
R282 918 150	1	-	For removing SMP snap-in R222 223 XXX
R282 920 010	2	U01	For male COAXIPACK 2 inserts
R282 920 100	3	U02	For female COAXIPACK 2 inserts

SMPM/SMP EXTRACTION TOOLS FOR ADAPTERS

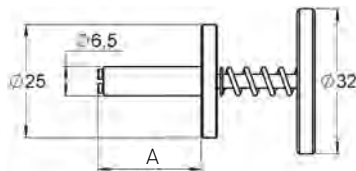

Part number	A dimension	Adapters
R282 918 200	23mm	SMPM R201 705 XXX
R282 918 120	150mm	SMP R222 705 XXX

SMPM/SMP/SMP-LOCK EXTRACTION TOOLS (for right angle cable plugs)



Fig. 1

Part number	Fig.	Plugs
R282 918 160	1	SMP R222 15X XXX
R282 868 300	1	SMP-LOCK R222 LXX XXX
R282 918 210	1	SMPM R201 15X XXX

COAXIPACK 2 EXTRACTION TOOL

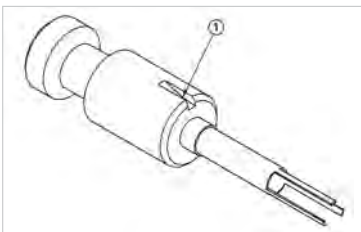

Part number
R282 920 120

HDC 43 INSERTION & EXTRACTION TOOL

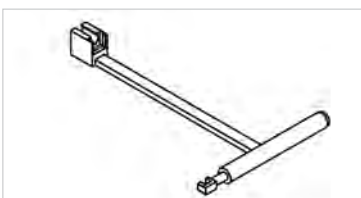

Part number
R282 868 201

Extraction Tools

**UMP EXTRACTION TOOL**



Photo 1

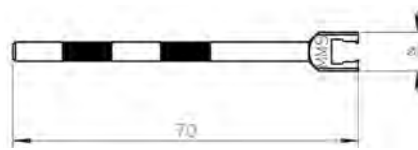
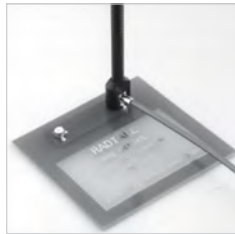

Photo 2

Part number	Photo	Note	To disconnect
R282 867 020	1	Axial disconnection	H2
R282 867 030	2	Lateral disconnection	H2, H2.6 & H3

This tool only applies to lock version. No tool needed for UMP snap of slide versions

**MMS AND MMT EXTRACTION TOOL**



Part number	Series
R282 868 040	MMT
R282 868 100	MMS

Materials and finish: black anodized aluminium. The anodization allows the electric insulation and protects from the oxidization.

**MML EXTRACTION TOOLS**



Part number	To disconnect	Packaging
R302 309 000	H2.5 & H2.0	Unit
R302 159 000	H1.5	

**QMA EXTRACTION TOOL (optional for high density applications)**

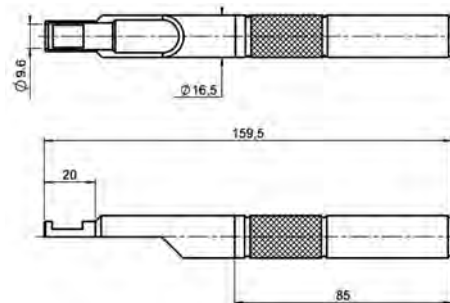

Part number
R282 868 230

This tool can be used with either straight or right angle connectors.

**QRE EXTRACTION TOOL**

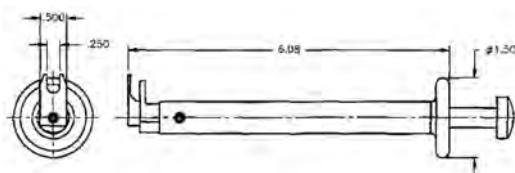

Part number
TA-0457

This tool can be used with either straight or right angle connectors.

Extraction Tools and Sliding Contacts

**EXTRACTION TOOL FOR RIGHT ANGLE MCX AND MMBX CONNECTORS AND CAP MOUNTING**



Part number	Flat dimension: inch (mm)
R282 868 000	.276 (7)

This tool has two functions  
 - Fitting cover on right angle connectors  
 - Extraction of these models after coupling

**OPTIONAL SLIDING CONTACTS AND INSULATORS**

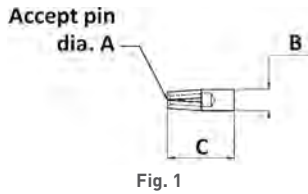

Fig. 1



Fig. 2

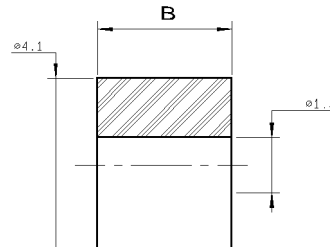

Fig. 3

Type	Part number	Fig.	Dimensions (mm)			Packaging
			A	B	C	
Socket	R280 181 000	1	0.9	1.28	14.8	10 pieces
	R280 469 000		0.3	0.85	3.43	
	R280 469 010		0.46			
	R280 470 000		0.28/0.38	0.77	1.84	
	R280 470 050		0.46			
Pin	R280 473 100	2	-	0.30	2.80	Unitary
	R280 473 130		-	0.5	5.6	
Insulator	R280 467 000	3	-	1.57	-	10 pieces
	R280 468 000		-	3.17	-	
	R280 468 120		-	10.1	-	
	R280 468 140		-	6.38	-	

**CONTACTS FOR FIELD REPLACEABLE RECEPTACLES, DIAMETER 0.93mm (.037")**

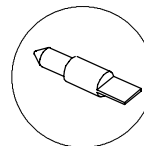
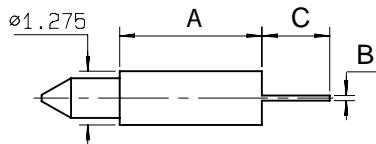
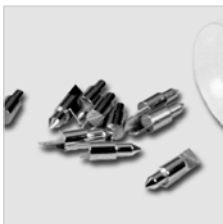

Fig. 1

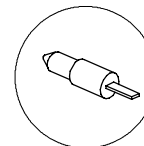

Fig. 2

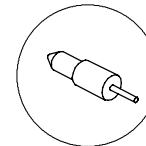

Fig. 3

Part number	Fig.	Termination	A	B	C	Packaging
R280 461 000	1	Tab	3.37	0.13	1.6	10 pieces
R280 461 200	2	Tab special	3.37	0.13 x W0.51	1.6	
R280 461 210	1	Tab	10.3	0.13	1.6	
R280 462 000	3	Cylindrical	1.77	dia 0.25	1.57	
R280 463 000			3.37			
R280 465 000	2	Tab special	0.2	0.13 x W0.60	0.9	



Glass Beads and EMI Gaskets

EMI/RFI GASKET

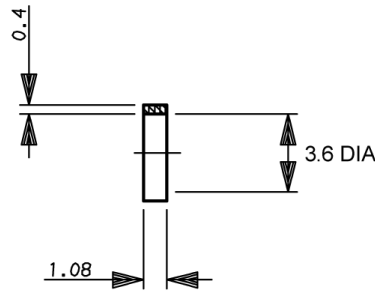

Part number	Packaging
R280 510 000	10 pieces

GLASS BEAD/HERMETIC SEALS

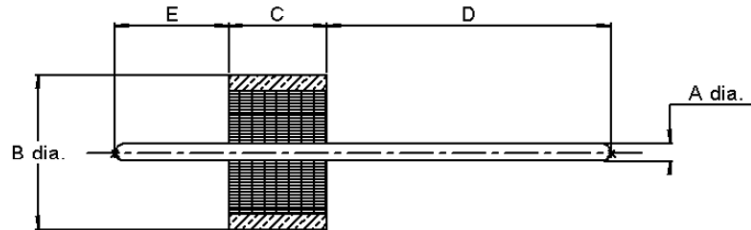

Hermeticity guaranteed at  $10^{-8}$  atm.cm<sup>3</sup>/s

Part number	Dimensions (mm)					Packaging	
	A	B	C	D	E		
R280 751 000	0.30 [.012]	2.52 [.099]	1.60 [.063]	4.57 [.180]	1.83 [.072]	1	
R280 751 080				1.3 [.051]		100	
R280 751 350				4.57 [.180]		1.83 [.072]	1
R280 752 000	0.38 [.015]	2.50 [.098]	1.56 [.061]	1.95 [.076]	1.59 [.062]	100	
R280 752 020				1.3 [.051]			
R280 755 000	0.46 [.018]	2.85 [.112]	1.60 [.063]	4.57 [.180]	1.83 [.072]	1	
R280 755 040							
R280 757 060	0.50 [.109]	4 [.157]	1.77 [.070]	1.78 [.070]	2.03 [.080]	100	
R280 757 070				5.82 [.230]		1.93 [.076]	1
R280 757 080				1.78 [.070]		1.93 [.076]	1
R280 760 000	0.30 [.012]	1.93 [.076]	1.40 [.055]	0.74 [.029]	1.04 [.041]	5	
R280 760 040				1.10 [.043]		1.72 [.068]	100
R280 760 050				1.10 [.043]		1.72 [.068]	



Insulated Washers

INSULATED WASHERS

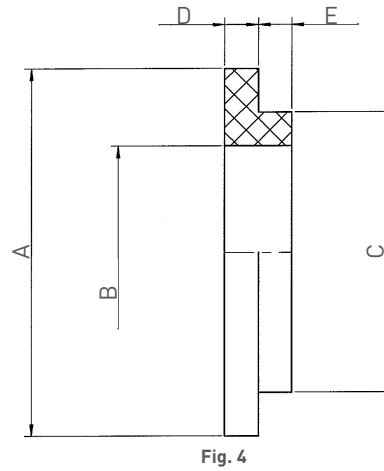
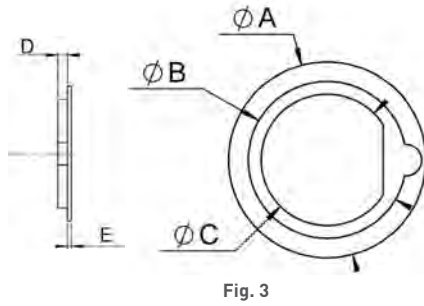
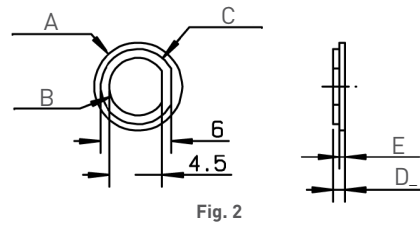
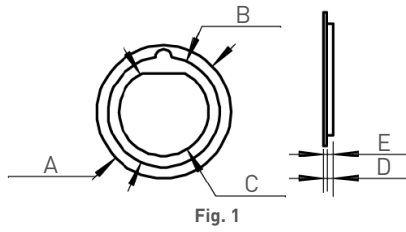

Part number	Fig.	To be used on (partial list)		Dimensions (mm)					Material	Packaging
				A	B	C	D	E		
R280 907 000	1	R141 304 000 R141 323 000 R141 324 000 R141 327 000 R141 332 161 R141 332 500	R141 338 000 R141 730 000 R141 753 000 R142 329 000 R142 334 161 R142 720 000	19.06	15.88	12.7	1.02	0.44	Nylon	100 sets (200 washers)
99762	3	R142 306 500 R142 306 503	R141 301 000 R141 303 503 R141 306 000 R141 306 503 R141 308 000	14.3	11.45	9.58	1	0.4		
R280 902 000	2	R142 562 290		16	12.6	9.6	1.5	0.7		
539 22 090	4	R125 720 000 R125 720 001 R125 722 001		11	8.4	6.4	1	1		

## TAG, Gaskets and Feedthrough

### SOLDER TAG

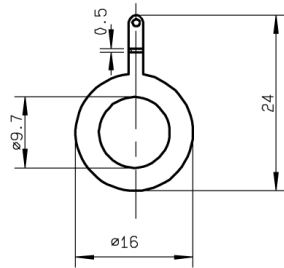

Part number	Finish	Packaging
R280 490 020	Nickel	100 units

### PANEL SEALING GASKETS

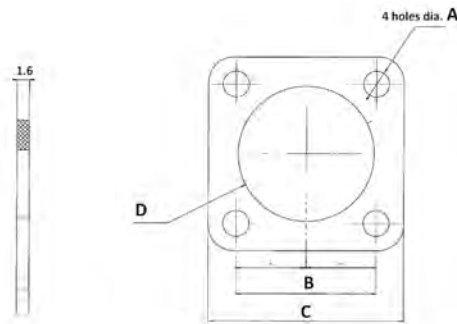

Part number	Series	Dimensions (mm)				Material
		A	B	C	D	
R280 505 000	N	∅ 3.4	18.25	25.4	17.7	Neoprene
R280 503 000	BNC	∅ 3	12.7	17.5	11.5	

### CABLE PANEL FEEDTHROUGH

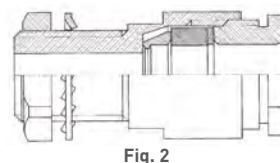
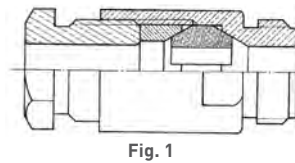

Part number	Fig.	Mounting type	Panel hole size	Cable group dia.	Cable group
R280 007 000	1	Thread-in	7/16 - 14 UNC 2A	5/50	RG58 / RG141 / RG142
R280 009 000			7/16 - 28 UNEF 2A		
R280 010 000			7/16 UNC 2A	6/75	RG59 / RG62
R280 019 000			11/16 24 NEF 2A	10/50 11/50	RG213 / RG393 / RG214 / RG216
R280 054 000	2	Bulkhead	4.9 mm	3 Max	RG178 / RG174 / RG316 / RG179
R280 257 000			8 mm	5/50	RG58 / RG141 / RG142
R280 254 000			4.9 mm	2.6/50	RG174 / RG178 / RG179

Cable Terminations

RIGHT ANGLE PCB CABLE TERMINATIONS

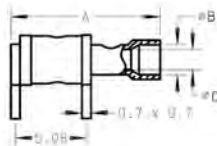

Fig. 1

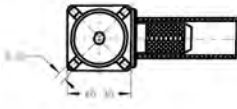

Fig. 2

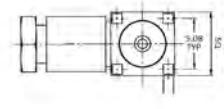

Fig. 4

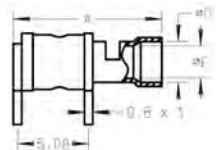

Fig. 3

Cable group	Cable dia.	Part number	Fig.	Dimensions (mm)			Panel drilling	Finish	Note
				A	B	C/E			
RG178 / RG196	2/50/S	R280 219 000	1	10.70	2.10	1.45	P03	Gold	2 pins / Solder
		7145-1521-002	2	9.39	9.65	1.01	-		4 pins / Crimp
RG174 / RG316 / RG179	2.6/50+75/S	R280 220 008	3	10.70	2.90	2.30	P04	Tin lead	2 pins / Solder
		R280 294 000	2	16.85	3.25	1.70	P01		4 pins / Crimp
RG405	.085"	8045-1541-010	4	14.98	3.07	-	-	Gold	4 pins / Clamp
RG174 / RG316	2.6/50S	8045-1551-003		-	-	-	-		4 pins / Crimp
RG178 / RG196	2/50S	8145-1521-003	4	17.44	3.09	-	P01	Gold	4 pins / Crimp
RD316	2.6/50D	8145-1521-002				-			
		8145-1521-019		3.50	-				

STRAIGHT PCB CABLE TERMINATIONS

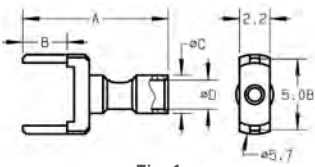

Fig. 1

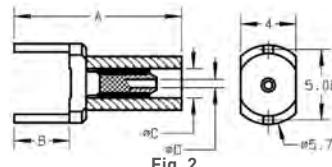

Fig. 2

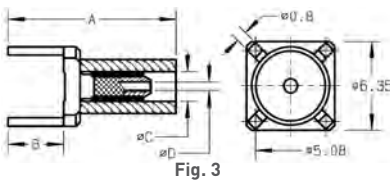
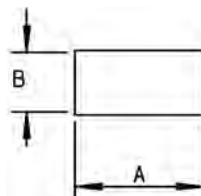

Fig. 3

Cable group	Cable dia.	Part number	Fig.	Dimensions (mm)				Panel drilling	Finish	Note
				A	B	C	D			
RG178 / RG196	2/50/S	R280 221 000	1	10.50	3.20	2.70	1.45	P02	Gold	2 pins / Solder
RG174 / RG316 / RG179	2.6/50 - 2.6/75/S	R280 222 000	2	8.40	3.20	3.15	2.30			
		R280 284 000	3	17.20	4.00	3.25	1.70	P01	Nickel	4 pins / Crimp

HEATSHRINK SLEEVES



Part number	B		A	Packaging
	Before shrinkage	After shrinkage		
R280 637 030	6.4	3.2	25.4	100
R280 637 040	12	6	45	

Heatshrink sleeves guarantee an IP65 moisture resistance on crimp type models and an IP 67 moisture resistance on clamp type models.

Heatshrink Sleeves and Cable Boots

**PROTECTIVES CAPS (material: PVC color: red)**

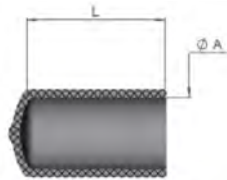

These caps protect the interface against dust and accidental interface damage during storage or handling.

Part number	Dimensions		Connectors series using these caps
	$\phi A$	L	
240 92 682	6	11.1	SSMA male, SMB female
240 92 671	6	19	SMA female, SMC female jack
240 92 672	8.7		SMA male
240 92 684	9		QMA male
240 92 673	10.3	22.2	TNC female, BNC female
240 92 674	13.5	25.4	TNC male, C female
240 92 675	14.3	25.4	BNC male
240 92 676	15.9		N female
240 92 677	17.4		C male
240 92 678	19	12.7	N male, HN female
A240 92 010	20.63		7/16 male
240 94 681	4	11.1	SSMA female, QMA female, 10/23 female, SMC male plug
241 92 040	29	10.5	7/16 female
Z241 92 080	20	30.5	4.3-10 female jack

**CABLE BOOTS (material: PVC)**

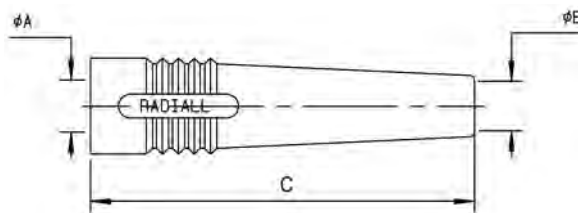

Cable group Color	2.6/50		5/50	6/75
	A: 5.5 - B: 2.6 C: 27	A: 5.5 - B: 2.6 C: 48	A: 5.5 - B: 5.1 - C: 48	A: 6.5 - B: 6.2 - C: 48
Black	R280 560 000	R280 566 000	R280 570 010 / R280 570 000*	R280 590 000
Red	R280 560 001	R280 566 001	R280 571 000	R280 591 000
Green	R280 560 002	R280 566 002	R280 572 000	R280 592 000
Blue	R280 560 003	R280 566 003	R280 573 000	R280 593 000
Yellow	R280 560 004	R280 566 004	R280 574 000	R280 594 000
Grey	R280 560 005	R280 566 005	R280 575 000	R280 595 000
White	R280 560 006	R280 566 006	R280 576 000	R280 596 000
Brown	R280 560 007	R280 566 007	R280 577 000	R280 597 000
Orange	R280 560 008	R280 566 008	R280 578 000	R280 598 000
Violet	-	-	R280 579 000	-

Standard packaging = 10 pieces - \* packaging = 100 pieces

Panel Drilling

P01

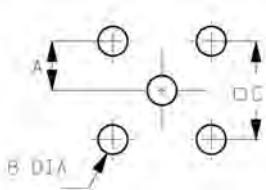

	MM		INCH	
	maxi	mini	maxi	mini
A	2.56	2.52	0.101	0.099
B	1.4	1.3	0.055	0.051
C	5.13	5.03	0.202	0.198

P02

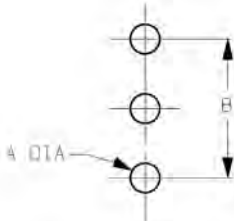

	MM		INCH	
	maxi	mini	maxi	mini
A	1.15	1.05	0.045	0.041
B	5.15	5.05	0.203	0.199

P03

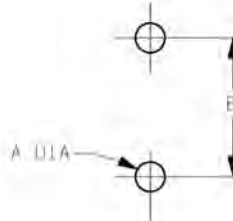

	MM		INCH	
	maxi	mini	maxi	mini
A	1.10	1.00	0.043	0.039
B	5.13	5.03	0.202	0.198

P04

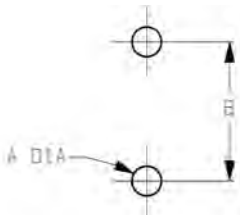

	MM		INCH	
	maxi	mini	maxi	mini
A	1.5	1.4	.059	.055
B	5.13	5.03	.202	.198

SIMPLIFICATION IS OUR INNOVATION

# NOTE





## COAXIAL CABLE ASSEMBLIES

C291

## Contents

**CABLE ASSEMBLIES**

Introduction .....	18-4
Specify the right cable for your application .....	18-5
Finder guide cables vs insertion loss .....	18-6 to 18-7

**FLEXIBLE CABLES (STANDARD)**

0.8/50 S cable (132390 type) .....	18-8
1/50 S cable (50VMTX type) .....	18-8
1/75 S cable (75VMTX type) .....	18-9
2/50 S cable (RG178-KX21A-RG178 non mag) .....	18-9 to 18-10
2/50 D cable (124416 type) .....	18-10
2/75 S cable (296775 type) .....	18-11
2.6/50 S cable (RG174-KX3B-RG316-KX22A) .....	18-11 to 18-12
2.6/50 D cable (RD316) .....	18-12
2.6/75 S cable (RG179) .....	18-13
4.6/75 D cable (HD 0.6/2.8-mini RG59 type) .....	18-13
5/50 S cable (RG58-KX15) .....	18-14
5/50 D cable (RG142-RG223-RG400-KX23) .....	18-14 to 18-16
6/75 S cable (RG59-KX6A) .....	18-16 to 18-17
6/75 D cable (HD 0.8/3.7-RG59 type) .....	18-17
7/75 D cable (HD 1.0/4.8-RG6 type) .....	18-18
10/50 S cable (RG213-KX4) .....	18-18
10/50 D cable (RG393) .....	18-19
11/50 D cable (RG214-KX13) .....	18-19
11/75 D cable (RG216) .....	18-20

**FLEXIBLE CABLES (LOW-LOSS ECO-FRIENDLY)**

2.6/50 S cable (ECO316-ECO316X) .....	18-20 to 18-21
2.6/50 D cable (ECO316D-ECO316DX) .....	18-21 to 18-22
5/50 D cable (ECO142-ECO142X-Power142) .....	18-22 to 18-23
6/50 D cable (ECO230) .....	18-24
10/50 D cable (ECO393-ECO393X) .....	18-24 to 18-25

**CORRUGATED CABLES**

Cable 1/4" spiral (HCF 1/4"-50 AlCu) .....	18-25
Cable 3/8" spiral (HCF 3/8" CuH-50 AlCu) .....	18-26
Cable 1/2" spiral (HCF 1/2" CuH-50 AlCu) .....	18-26

**SEMI-RIGID AND HAND-FORMABLE CABLES**

.047" cable (SR copper-SR tinned copper) .....	18-27
.085" cable (Handformable unjacketed-SR RG405/KS1-SR tinned copper-SR non magnetic-SR aluminum) .....	18-28 to 18-30
.141" cable (Handformable unjacketed-Handformable FEP jacketed-SR RG402/KS2 SR tinned copper-SR silvered copper-SR non magnetic-SR aluminum) .....	18-30 to 18-33
.250" cable (SR RG401/KS3-SR aluminum) .....	18-34

**LOW-LOSS FLEXIBLE CABLES**

AEP-100FR (LMR® 100) .....	18-35
AEP-195FR (LMR® 195) .....	18-36
AEP-200FR (LMR® 200) .....	18-37
AEP-240FR (LMR® 240) .....	18-38
AEP-400FR (LMR® 400) .....	18-39
AEP-600FR (LMR® 600) .....	18-40

<b>SHF ULTRA LOW LOSS CABLES</b> .....	18-41 to 18-44
--	----------------

**Radiall cable groups**

Example for flexible cables: 5/50 S

— Cable outer diameter in mm (2.6 mm, 5 mm, 10 mm, 11 mm,...)  
 — Characteristic impedance (50Ω, 75Ω)  
 — Number of shields (S=single, D=double)

Example for corrugated cables: 1/2 spiral

— Cable outer conductor diameter in fraction of inch (1/4", 3/8", 1/2",...)

Example for semi-rigid & handformable cables: .141"

— Cable outer conductor diameter in inches (.085", .141", .250",...)



## Introduction

Radiall is globally recognized as a leading manufacturer of coaxial connectors, cable and cable assemblies.

Radiall has top tier manufacturing technology and processes. As a result, we are one of the only manufacturers that have fully mastered foam PTFE wrapping technology. This capability enables us to supply cable assemblies featuring the highest level of performance, stability and repeatability.

In addition, Radiall has high precision stripping and cutting machines, soldering and cleaning equipment.

Radiall offers five standard ranges of cable for a wide variety of applications for the telecom, military, instrumentation, medical and broadcast markets.

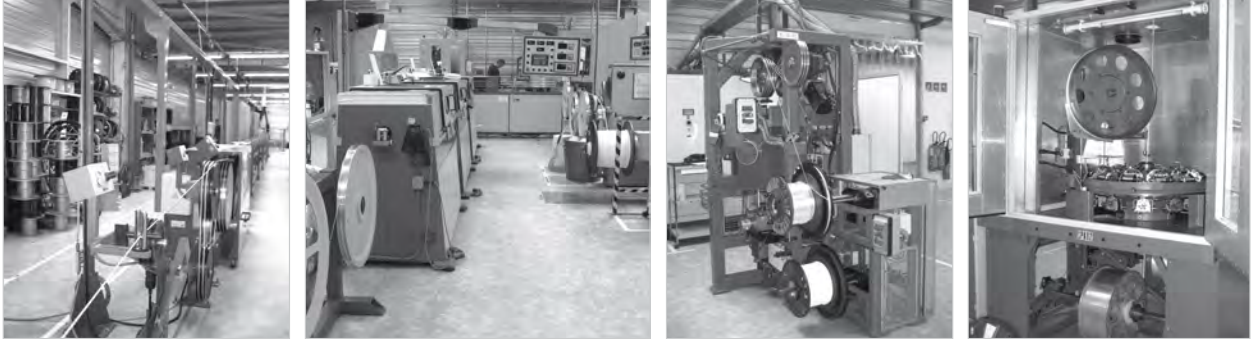

## Requirements for Designing a Custom Cable Assembly

Start with identifying the needed components and the required information for your cable assembly:

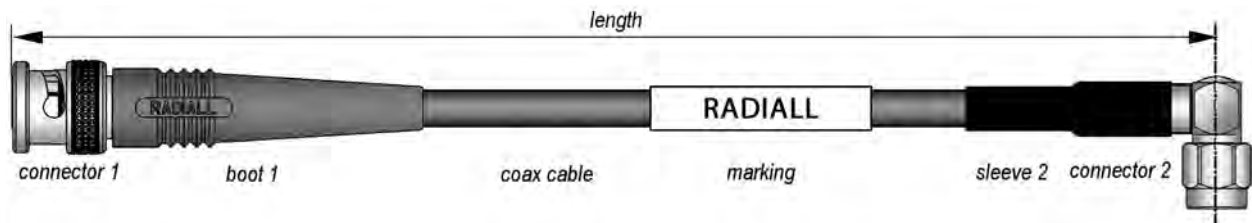

- Coaxial cable (p/n or description)
- Connector 1 (p/n or description)
- Optional boot 1 or heat-shrink sleeve 1 (p/n or description)
- Connector 2 (p/n or description)
- Optional boot or sleeve 2 (p/n or description)
- Length: radiall standard = overall length (or please specify if length between reference planes)
- + Length tolerance (radiall standard =  $\pm 2\%$ )
- Marking: Radiall standard = RADIALL + p/n + batch code (or please specify if different)
- Connectors orientation (if needed for right-angle or panel connectors)

For you will also need the following dimensions and information:

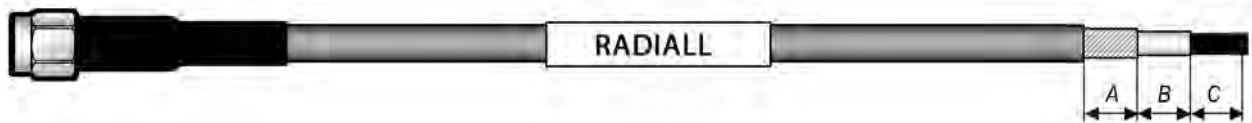

- Stripping A dimension
- Stripping B dimension
- Stripping C dimension
- Tinned inner conductor (if needed)
- Tinned braid (if needed)

Specify the Right Cable for Your Application

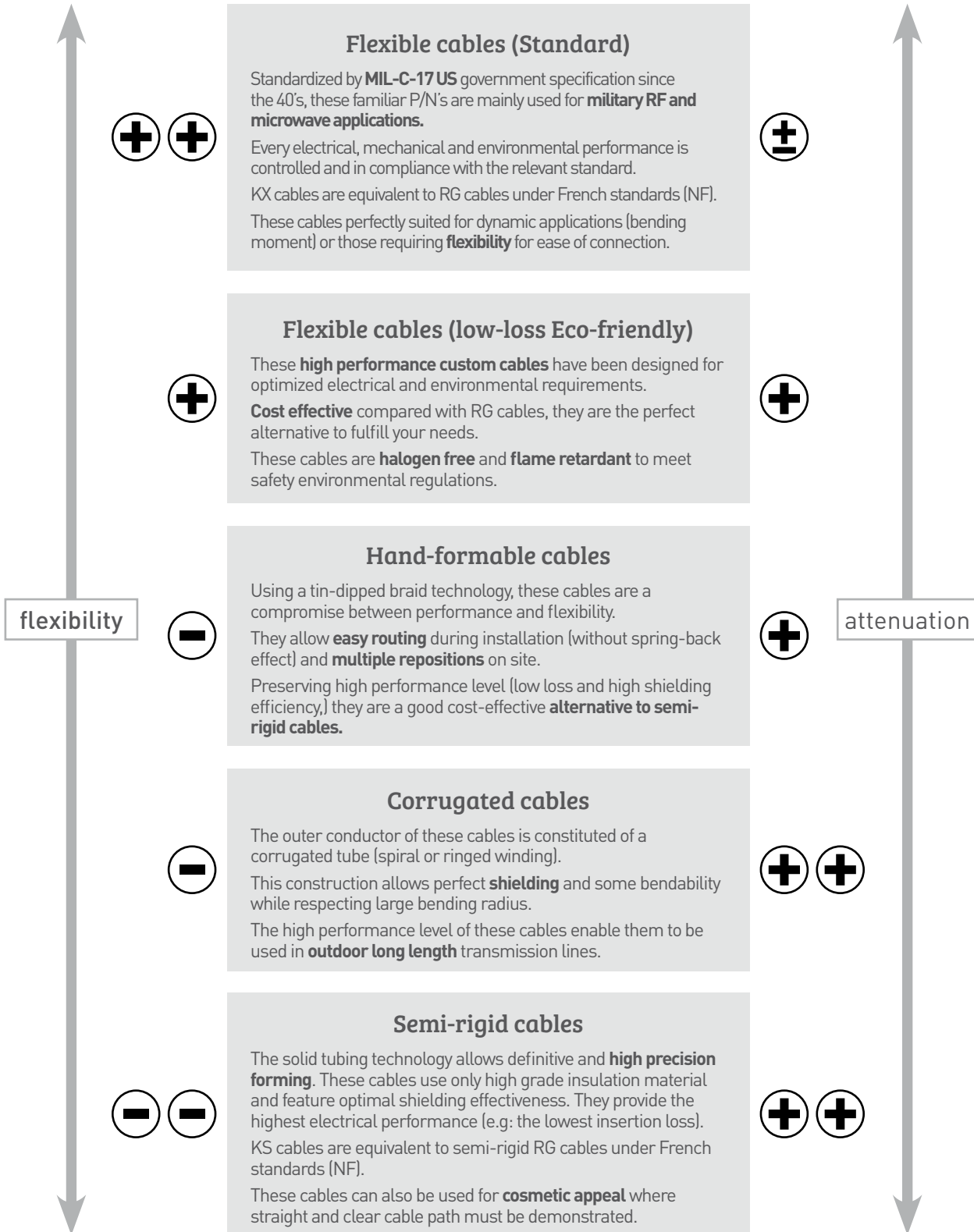

## Finder Guide - Cables vs Insertion Loss

## FLEXIBLE CABLES (STANDARD)

Cable group	Cable p/n	Cable type	1 GHz (VHF/UHF) dB/m dB/ft	2 GHz (band L) dB/m dB/ft	3 GHz (band S) dB/m dB/ft	6 GHz (band C) dB/m dB/ft	8 GHz (band C) dB/m dB/ft	12.4 GHz (band X) dB/m dB/ft
0.8/50 S	C291 042 066	132390 type	2.41/0.73	3.51/1.06	4.93/1.49	-	-	-
1/50 S	C291 050 066	50 VMTX type	2.12/0.64	3.36/1.02	4.45/1.35	-	-	-
1/75 S	C291 055 076	75 VMTX type	2.22/0.67	3.14/0.95	-	-	-	-
2/50 S	C291 145 007/017	RG178/KX21	1.54/0.47	2.20/0.67	2.72/0.82	-	-	-
	C291 140 087	RG178 non mag type	1.34/0.41	1.92/0.58	2.37/0.72	-	-	-
2/50 D	C291 146 087	124416 type	1.34/0.41	1.92/0.58	2.37/0.72	-	-	-
2/75 S	C291 147 060	296775 type	1.38/0.42	1.98/0.60	2.46/0.75	-	-	-
2.6/50 S	C291 150 000/010	RG174/KX3B	1.07/0.32	-	-	-	-	-
	C291 170 007/017	RG316/KX22A	0.86/0.26	1.24/0.38	1.54/0.47	-	-	-
2.6/50 D	C291 185 067	RD316	0.86/0.26	1.24/0.38	1.54/0.47	-	-	-
2.6/75 S	C291 210 007	RG179	0.95/0.29	1.37/0.41	1.70/0.51	-	-	-
5/50 S	C291 305 000/010	RG58/KX15	0.67/0.20	-	-	-	-	-
5/50 D	C291 320 007	RG142	0.44/0.13	0.65/0.20	0.81/0.25	1.22/0.37	1.45/0.44	1.90/0.58
	C291 330 000	RG223	0.46/0.14	0.67/0.20	0.85/0.26	1.27/0.38	1.51/0.46	1.97/0.60
	C291 324 007	RG400	0.52/0.16	0.76/0.23	0.95/0.29	1.42/0.43	1.68/0.51	2.19/0.66
	C291 322 017	KX23	0.48/0.14	0.70/0.21	0.89/0.27	1.35/0.41	1.61/0.49	-
	C291 325 270	POWER142	0.41/0.12	0.58/0.18	0.72/0.22	-	-	-
6/75 S	C291 360 000	RG59	0.44/0.13	-	-	-	-	-
	C291 351 012	KX6A	0.48/0.15	-	-	-	-	-
10/50 S	C291 510 000/010	RG213/KX4	0.24/0.07	-	-	-	-	-
10/50 D	C291 511 007	RG393	0.23/0.07	0.35/0.11	0.45/0.14	0.71/0.21	0.86/0.26	1.07(11)/0.32(11)
11/50 D	C291 600 000/010	RG214/KX13	0.24/0.07	0.36/0.11	0.47/0.14	0.73/0.22	0.89/0.27	1.1(11)/0.33(11)
11/75 D	C291 610 000	RG216	0.32/0.10	0.48/0.14	0.60/0.18	-	-	-

(11) = 11 GHz

## FLEXIBLE CABLES (LOW-LOSS ECO-FRIENDLY)

(alternative to RG cables - in accordance with RoHS regulation)

Cable group	Cable p/n	Cable type	1 GHz (VHF/UHF) dB/m dB/ft	2 GHz (band L) dB/m dB/ft	3 GHz (band S) dB/m dB/ft	6 GHz (band C) dB/m dB/ft
2.6/50 S	C291 999 904	ECO316	0.76/0.23	1.09/0.33	1.34/0.41	-
	C291 171 083	ECO316X	0.96/0.29	1.45/0.44	1.85/0.56	-
2.6/50 D	C291 999 905	ECO316D	0.76/0.23	1.09/0.33	1.34/0.41	-
	C291 217 020	ECO316DX	0.86/0.26	1.30/0.40	1.68/0.51	2.64/0.80
5/50 D	C291 325 290	ECO142	0.41/0.12	0.58/0.18	0.72/0.22	-
	C291 320 180	ECO142X	0.54/0.16	0.83/0.25	1.07/0.32	1.70/0.51
6/50 D	C291 326 490	ECO230	0.28/0.08	0.40/0.12	0.50/0.15	0.59/0.18(4)
10/50 D	C291 491 060	ECO393	0.16/0.05	0.24/0.07	0.30/0.09	-
	C291 512 020	ECO393X	0.29/0.09	0.47/0.14	0.64/0.19	1.11/0.34

(4) = 4 GHz

## LOW-LOSS FLEXIBLE CABLES (AEP-xxxFR cables)

Cable group	Cable p/n	Cable type	1 GHz (VHF/UHF) dB/m dB/ft	2 GHz (band L) dB/m dB/ft	3 GHz (band S) dB/m dB/ft	6 GHz (band C) dB/m dB/ft
AEP-100FR	C291 327 060	LMR® 100	0.79/0.24	1.16/0.35	1.45/0.44	2.15/0.65
AEP-195FR	C291 327 010	LMR® 195	0.39/0.12	0.55/0.17	0.69/0.21	1.00/0.3
AEP-200FR	C291 327 020	LMR® 200	0.34/0.10	0.49/0.15	0.61/0.19	0.88/0.27
AEP-240FR	C291 327 030	LMR® 240	0.26/0.08	0.38/0.11	0.47/0.14	0.68/0.21
AEP-400FR	C291 327 040	LMR® 400	0.14/0.04	0.20/0.06	0.24/0.07	0.36/0.11
AEP-600FR	C291 327 050	LMR® 600	0.09/0.03	0.13/0.04	0.16/0.05	0.24/0.07

## Finder Guide - Cables vs Insertion Loss

## STANDARD FLEXIBLE HD CABLES

Cable group	Cable p/n	Cable type	1 GHz (VHF/UHF) dB/m dB/ft	2 GHz (band L) dB/m dB/ft	3 GHz (band S) dB/m dB/ft	4.5 GHz (band C) dB/m dB/ft
4.6/75 D	C291 333 039	HD 0.6/2.8 mini RG59 type	0.34/0.10	0.50/0.15	0.62/0.19	-
6/75 D	C291 360 093	HD 0.8/3.7 RG59 type	0.25/0.07	0.35/0.11	0.44/0.13	0.54/0.16
7/75 D	C291 384 083	HD 1.0/4.8 RG6 type	0.19/0.06	0.28/0.08	0.35/0.11	0.44/0.13

## CORRUGATED CABLES (spiral outer shielding)

Cable group	Cable p/n	Cable type	2 GHz (band L) dB/m dB/ft	3 GHz (band S) dB/m dB/ft	6 GHz (band C) dB/m dB/ft	8 GHz (band C) dB/m dB/ft	12.4 GHz (band X) dB/m dB/ft	18 GHz (band Ku) dB/m dB/ft	20 GHz (band Ku) dB/m dB/ft
Celiflex 1/4"	C291 993 170	HCF 1/4"-50 AlCu	0.27/0.08	0.34/0.10	0.51/0.15	0.60/0.18	0.78/0.24	0.99/0.30	1.06/0.32
Celiflex 3/8"	C291 996 170	HCF 3/8" CuH-50 AlCu	0.19/0.06	0.24/0.07	0.36/0.11	0.43/0.13	0.54(11.7)/ 0.16(11.7)	-	-
Celiflex 1/2"	C291 994 170	HCF 1/2" CuH-50 AlCu	0.16/0.05	0.20/0.06	0.30/0.09	0.36/0.11	0.42(10)/ 0.13(11.7)	-	-

(11.7) = 11.7 GHz (10) = 10 GHz

## HAND-FORMABLE AND SEMI-RIGID CABLES

Cable group	Cable p/n	Cable type	2 GHz (band L) dB/m dB/ft	3 GHz (band S) dB/m dB/ft	6 GHz (band C) dB/m dB/ft	8 GHz (band C) dB/m dB/ft	12.4 GHz (band X) dB/m dB/ft	18 GHz (band Ku) dB/m dB/ft	20 GHz (band Ku) dB/m dB/ft
.047"	C291 855 001	SR copper	1.64/0.50	2.03/0.61	2.93/0.89	3.43/1.04	4.73/1.32	5.39/1.63	5.72/1.73
	C291 855 065	SR tinned copper	1.64/0.50	2.03/0.61	2.93/0.89	3.43/1.04	4.73/1.32	5.39/1.63	5.72/1.73
.085"	C291 844 065	Handformable unjacketed	0.97/0.29	1.21/0.37	1.78/0.54	2.10/0.64	2.71/0.82	3.39/1.03	3.62/1.10
	C291 850 001	SR RG405/KS1	0.94/0.29	1.18/0.36	1.73/0.53	2.05/0.62	2.64/0.80	3.31/1.00	3.53/1.07
	C291 850 005	SR tinned copper	0.94/0.29	1.18/0.36	1.73/0.53	2.05/0.62	2.64/0.80	3.31/1.00	3.53/1.07
	C291 851 001	SR non magnetic	0.94/0.29	1.18/0.36	1.73/0.53	2.05/0.62	2.64/0.80	3.31/1.00	3.53/1.07
	C291 844 187	SR aluminum	0.98/0.30	1.22/0.37	1.80/0.54	2.12/0.64	2.73/0.83	3.41/1.03	3.64/1.10
.141"	C291 864 065	Handformable unjacketed	0.57/0.17	0.72/0.22	1.09/0.33	1.30/0.39	1.71/0.52	2.18/0.66	2.34/0.71
	C291 866 378	Handformable FEP jacketed	0.63/0.19	0.80/0.24	1.20/0.36	1.42/0.43	1.87/0.57	2.37/0.72	2.54/0.77
	C291 860 001	SR RG402/KS2	0.50/0.15	0.64/0.19	0.97/0.30	1.17/0.35	1.55/0.47	1.99/0.60	2.14/0.65
	C291 862 005	SR tinned copper	0.50/0.15	0.64/0.19	0.97/0.30	1.17/0.35	1.55/0.47	1.99/0.60	2.14/0.65
	C291 861 066	SR silvered copper	0.50/0.15	0.64/0.19	0.97/0.30	1.17/0.35	1.55/0.47	1.99/0.60	2.14/0.65
	C291 861 061	SR non magnetic	0.50/0.15	0.64/0.19	0.97/0.30	1.17/0.35	1.55/0.47	1.99/0.60	2.14/0.65
	C291 864 187	SR aluminum	0.53/0.16	0.67/0.20	1.02/0.31	1.23/0.37	1.62/0.49	2.08/0.63	2.23/0.38
.250"	C291 870 001	SR RG401/KS3	0.31/0.09	0.41/0.12	0.64/0.20	0.79/0.24	1.08/0.33	1.42/0.43	1.54/0.47
	C291 874 187	SR aluminum	0.33/0.10	0.43/0.13	0.68/0.21	0.83/0.25	1.13/0.34	1.48/0.45	1.60/0.49

## Flexible cable 0.8/50 S (132390 type)



**P/N: C291042066**

### APPLICATION NOTE

The very small outer diameter and bending moment of this cable allow very easy routing during installation.

Its very light weight makes it perfect to be used in all miniature and space saving applications.

The insulation and jacket materials allow this cable to be used in severe thermal conditions.

## CONSTRUCTION / DIMENSIONS

	Material	mm	Inches
Center conductor	Solid SPC <sup>(1)</sup>	0.16	0.006
Dielectric	Solid PFA <sup>(2)</sup>	0.50	0.020
Inner shield	SPC <sup>(1)</sup> braid	0.70	0.028
Outer shield	-	-	-
Jacket	White FEP <sup>(3)</sup>	0.83 max	0.033 max

## ELECTRICAL CHARACTERISTICS

Characteristic impedance	50Ω ± 3Ω	
Operating frequency range	DC - 3 GHz	
Shielding effectiveness	40 dB	
Voltage withstanding	18 000 V rms	
Peak power	6 kW	
Capacitance	98.7 pF / m	29.9 pF / ft
Velocity of propagation	69 % (4.8 ns / m)	

## MECHANICAL CHARACTERISTICS

Recommended minimum bending radius	4 mm	0.157 inch
Weight	1.8 g / m	0.001 lbs / ft

## ENVIRONMENTAL CHARACTERISTICS

Operating temperature range	-50 / +200 °C	-58 / +392 °F
Fire resistance	Yes (UL94V0)	
Halogen free	No	

## FREQUENCY / ATTENUATION (typ.) / CW MAX POWER (sea level / 40 °C)

GHz	dB / m	dB / ft	Watts
0.1	0.64	0.19	45
0.2	0.88	0.27	34
0.3	1.90	0.58	28
0.4	1.28	0.39	22
0.5	1.48	0.45	20
1.0	2.41	0.73	14
1.5	3.03	0.92	12
2.0	3.51	1.06	10
2.5	4.20	1.27	9
3.0	4.93	1.49	8

<sup>(1)</sup> SPC = Silver Plated Copper

<sup>(2)</sup> PFA = PerFluoroAlkoxy

<sup>(3)</sup> FEP = Fluorinated Ethylene Propylene

### Note:

Typical attenuation for a couple of connectors (dB) = 0.045 x √f (GHz)

## Flexible cable 1/50 S (50 vmtx type)



**P/N: C291050066**

### APPLICATION NOTE

The very small outer diameter and bending moment of this cable allow very easy routing during installation.

Its very light weight makes it perfect to be used in all miniature and space saving applications.

The insulation and jacket materials allow this cable to be used in severe thermal conditions.

## CONSTRUCTION / DIMENSIONS

	Material	mm	Inches
Center conductor	Solid SPC <sup>(1)</sup>	0.17	0.007
Dielectric	Solid PTFE <sup>(2)</sup>	0.52	0.020
Inner shield	SPC <sup>(1)</sup> braid	0.70	0.028
Outer shield	-	-	-
Jacket	White FEP <sup>(3)</sup>	1.17	0.046

## ELECTRICAL CHARACTERISTICS

Characteristic impedance	50Ω ± 5Ω	
Operating frequency range	DC - 3 GHz	
Shielding effectiveness	40 dB	
Voltage withstanding	19 000 V rms	
Peak power	7 kW	
Capacitance	94 pF / m	28.5 pF / ft
Velocity of propagation	69 % (4.8 ns / m)	

## MECHANICAL CHARACTERISTICS

Recommended minimum bending radius	6 mm	0.236 inch
Weight	3 g / m	0.002 lbs / ft

## ENVIRONMENTAL CHARACTERISTICS

Operating temperature range	-90 / +200 °C	-130 / +392 °F
Fire resistance	Yes (UL94V0)	
Halogen free	No	

## FREQUENCY / ATTENUATION (typ.) / CW MAX POWER (sea level / 40 °C)

GHz	dB / m	dB / ft	Watts
0.1	0.54	0.16	82
0.2	0.80	0.24	58
0.3	1.01	0.31	45
0.4	1.20	0.36	39
0.5	1.37	0.42	34
1.0	2.12	0.64	25
1.5	2.76	0.84	21
2.0	3.36	1.02	17
2.5	3.91	1.19	15
3.0	4.45	1.35	14
Attenuation calculation (dB/m)	[1.51 x √f (GHz)] + [0.61 x f (GHz)]		

<sup>(1)</sup> SPC = Silver Plated Copper

<sup>(2)</sup> PTFE = PolyTetraFluoroEthylene

<sup>(3)</sup> FEP = Fluorinated Ethylene Propylene

**Flexible cable 1/75 S (75 vmtx type)****P/N: C291 055 076****APPLICATION NOTE**

Due to its 75 ohms characteristic impedance, this cable is best suited for TV/Video applications.  
The very small outer diameter and bending moment allow very easy routing during installation.  
Its very light weight makes it perfect to be used in all miniature, space saving and dynamic applications.  
Suitable for severe thermal conditions.

**CONSTRUCTION / DIMENSIONS**

	Material	mm	Inches
Center conductor	Solid SPCCS <sup>(1)</sup>	0.10	0.004
Dielectric	Solid PTFE <sup>(2)</sup>	0.57	0.022
Inner shield	SPC <sup>(3)</sup> braid	0.80	0.031
Outer shield	-	-	-
Jacket	White FEP <sup>(4)</sup>	1.22	0.048

**ELECTRICAL CHARACTERISTICS**

Characteristic impedance	80Ω ± 8Ω	
Operating frequency range	DC - 2 GHz	
Shielding effectiveness	40 dB	
Voltage withstanding	2 600 V rms	
Peak power	0.9 kW	
Capacitance	60 pF / m	18.3 pF / ft
Velocity of propagation	69 % (4.8 ns / m)	

**MECHANICAL CHARACTERISTICS**

Recommended minimum bending radius	6.1 mm	0.240 inch
Weight	3 g / m	0.002 lbs / ft

**ENVIRONMENTAL CHARACTERISTICS**

Operating temperature range	-90 / +200 °C	-130 / +392 °F
Fire resistance	Yes (UL94V0)	
Halogen free	No	

**FREQUENCY / ATTENUATION (typ.) / CW MAX POWER (sea level / 40 °C)**

GHz	dB / m	dB / ft	Watts
0.1	0.70	0.21	86
0.2	0.99	0.30	64
0.3	1.21	0.37	50
0.4	1.40	0.42	41
0.5	1.57	0.47	38
0.6	1.71	0.52	35
0.8	1.98	0.60	30
1.0	2.22	0.67	26
1.5	2.71	0.82	21
2.0	3.14	0.95	18
Attenuation calculation (dB/m)	[2.21 x √f GHz] + [0.005 x f GHz]		

<sup>(1)</sup> SPCCS = Silver Plated Copper covered steel<sup>(2)</sup> PTFE = PolyTetraFluoroEthylene<sup>(3)</sup> SPC = Silver Plated Copper<sup>(4)</sup> FEP = Fluorinated Ethylene Propylene**Note:**

Typical attenuation for a couple of connectors (dB) = 0.045 x √f (GHz)

**Flexible cable 2/50 S (RG178 - KX21A)****P/N: C291 145 007****(MIL-C-17/93-RG178)****P/N: C291 145 017****(NF-C-93/550-KX21A)****APPLICATION NOTE**

Due to its small diameter and its stranded inner conductor, RG 178 / KX21A is used for applications requiring high flexibility.

Its very low bending moment allows an easy routing during installation.

The insulation and jacket materials allow this cable to be used in severe thermal conditions.

**CONSTRUCTION / DIMENSIONS**

	Material	mm	Inches
Center conductor	Stranded SPCCS <sup>(1)</sup>	0.30	0.012
Dielectric	Solid PTFE <sup>(2)</sup>	0.84	0.033
Inner shield	SPC <sup>(3)</sup> braid	1.30	0.051
Outer shield	-	-	-
Jacket	Brown FEP <sup>(4)</sup>	1.78	0.07

**ELECTRICAL CHARACTERISTICS**

Characteristic impedance	50Ω ± 3Ω	
Operating frequency range	DC - 3 GHz	
Shielding effectiveness	40 dB	
Voltage withstanding	2 000 V rms	
Peak power	1 kW	
Capacitance	96 pF / m	29 pF / ft
Velocity of propagation	70 % (4.8 ns / m)	

**MECHANICAL CHARACTERISTICS**

Recommended minimum bending radius	7 mm	0.275 inch
Weight	8 g / m	0.0053 lbs / ft

**ENVIRONMENTAL CHARACTERISTICS**

Operating temperature range	-55 / +200 °C	-67 / +392 °F
Fire resistance	Yes (CSA FT6 / IEC 332-2)	
Halogen free	No	

**FREQUENCY / ATTENUATION (typ.) / CW MAX POWER (sea level / 25 °C)**

GHz	dB / m	dB / ft	Watts
0.1	0.48	0.14	190
0.2	0.68	0.21	134
0.3	0.83	0.25	110
0.5	1.08	0.33	85
1.0	1.54	0.47	60
1.5	1.90	0.57	49
2.0	2.20	0.67	42
2.5	2.47	0.75	38
3.0	2.72	0.82	35
Attenuation calculation (dB/m)	[1.50 x √f GHz] + [0.04 x f GHz]		
Power calculation (W)	60 / √f GHz		

<sup>(1)</sup> SPCCS = Silver Plated Copper covered steel<sup>(2)</sup> PTFE = PolyTetraFluoroEthylene<sup>(3)</sup> SPC = Silver Plated Copper<sup>(4)</sup> FEP = Fluorinated Ethylene Propylene



## Flexible cable 2/50 S (non magnetic RG178 type)



**P/N: C291 140 087  
(MIL-C-17/93-RG178)**

### APPLICATION NOTE

Based on MIL-C17/93 US standard, this cable is used where non magnetic is required.

In addition the solid inner conductor allows reduced attenuation in comparison with standard RG178.

The insulation and jacket materials allow this cable to be used in severe thermal conditions.

## CONSTRUCTION / DIMENSIONS

	Material	mm	Inches
Center conductor	Solid SPC <sup>(1)</sup>	0.29	0.0114
Dielectric	Solid PTFE <sup>(2)</sup>	0.84	0.033
Inner shield	SPC <sup>(1)</sup> braid	1.30	0.051
Outer shield	-	-	-
Jacket	Brown FEP <sup>(3)</sup>	1.80	0.071

## ELECTRICAL CHARACTERISTICS

Characteristic impedance	50Ω ± 2Ω	
Operating frequency range	DC - 3 GHz	
Shielding effectiveness	40 dB	
Voltage withstanding	2 000 V rms	
Peak power	1 kW	
Capacitance	100 pF / m	30 pF / ft
Velocity of propagation	70 % (4.8 ns / m)	

## MECHANICAL CHARACTERISTICS

Recommended minimum bending radius	9 mm	0.354 inch
Weight	8 g / m	0.0053 lbs / ft

## ENVIRONMENTAL CHARACTERISTICS

Operating temperature range	-55 / +200 °C	-67 / +392 °F
Fire resistance	Yes (CSA FT6 / IEC 332-2)	
Halogen free	No	

## FREQUENCY / ATTENUATION (typ.) / CW MAX POWER (sea level / 25 °C)

GHz	dB / m	dB / ft	Watts
0.1	0.42	0.13	253
0.2	0.59	0.18	179
0.3	0.72	0.22	146
0.5	0.94	0.28	113
1.0	1.34	0.41	80
1.5	1.65	0.50	65
2.0	1.92	0.58	57
2.5	2.16	0.65	51
3.0	2.37	0.72	46
Attenuation calculation (dB/m)	(1.30 x √f GHz) + (0.04 x f GHz)		
Power calculation (W)	80 / √f GHz		

<sup>(1)</sup> SPC = Silver Plated Copper

<sup>(2)</sup> PTFE = PolyTetraFluoroEthylene

<sup>(3)</sup> FEP = Fluorinated Ethylene Propylene

### Note:

Typical attenuation for a couple of connectors (dB) = 0.045 x √f (GHz)

## Flexible cable 2/50 D (124416 type)



**P/N: C291 146 087**

### APPLICATION NOTE

Due to its small diameter this cable will be used for applications requiring flexibility.

Its low bending moment allows an easy routing during installation.

The double braid provides a higher level of shielding in comparison with 2mm single braided cables.

In addition the solid inner conductor provides a very good attenuation level.

The insulation and jacket materials allow this cable to be used in severe thermal conditions.

## CONSTRUCTION / DIMENSIONS

	Material	mm	Inches
Center conductor	Solid SPC <sup>(1)</sup>	0.29	0.011
Dielectric	Solid PTFE <sup>(2)</sup>	0.84	0.033
Inner shield	SPC braid	1.27	0.050
Outer shield	SPC braid	1.60	0.063
Jacket	Brown FEP <sup>(3)</sup>	2.10	0.083

## ELECTRICAL CHARACTERISTICS

Characteristic impedance	50Ω ± 2Ω	
Operating frequency range	DC - 3 GHz	
Shielding effectiveness	80 dB	
Voltage withstanding	3 000 V rms	
Peak power	1.8 kW	
Capacitance	105 pF / m	32 pF / ft
Velocity of propagation	69 % (4.8 ns / m)	

## MECHANICAL CHARACTERISTICS

Recommended minimum bending radius	12.5 mm	0.49 inch
Weight	12.5 g / m	0.0083 lbs / ft

## ENVIRONMENTAL CHARACTERISTICS

Operating temperature range	-90 / +200 °C	-130 / +392 °F
Fire resistance	Yes (UL94V0)	
Halogen free	No	

## FREQUENCY / ATTENUATION (typ.) / CW MAX POWER (sea level / 40 °C)

GHz	dB / m	dB / ft	Watts
0.1	0.42	0.13	253
0.2	0.59	0.18	179
0.3	0.72	0.22	146
0.5	0.94	0.28	113
1.0	1.34	0.41	80
1.5	1.65	0.50	65
2.0	1.92	0.58	57
2.5	2.16	0.65	51
3.0	2.37	0.72	46
Attenuation calculation (dB/m)	(1.30 x √f GHz) + (0.04 x f GHz)		
Power calculation (W)	80 / √f GHz		

<sup>(1)</sup> SPC = Silver Plated Copper

<sup>(2)</sup> PTFE = PolyTetraFluoroEthylene

<sup>(3)</sup> FEP = Fluorinated Ethylene Propylene

**Flexible cable 2/75 S (296775 type)****P/N: C291 147 060****APPLICATION NOTE**

Due to its 75 ohms characteristic impedance, this cable is best suited for TV/Video and networks applications. Its small diameter and light weight make it perfect to be used in all miniature, space saving and dynamic applications.

**CONSTRUCTION / DIMENSIONS**

	Material	mm	Inches
Center conductor	Solid SPCCS <sup>(1)</sup>	0.17	0.007
Dielectric	Solid PE <sup>(2)</sup>	1.00	0.039
Inner shield	SPC <sup>(3)</sup> braid	1.32	0.052
Outer shield	-	-	-
Jacket	Black LSZH PE <sup>(4)</sup>	1.90	0.075

**ELECTRICAL CHARACTERISTICS**

Characteristic impedance	75Ω ± 5Ω	
Operating frequency range	DC - 3 GHz	
Shielding effectiveness	50 dB min	
Voltage withstanding	8 000 V rms	
Peak power	400 W	
Capacitance	67 pF / m	20.1 pF / ft
Velocity of propagation	66 % [5 ns / m]	

**MECHANICAL CHARACTERISTICS**

Recommended minimum bending radius	10 mm	0.394 inch
Weight	6.6 g / m	0.0044 lbs / ft

**ENVIRONMENTAL CHARACTERISTICS**

Operating temperature range	-60 / +85 °C	-40 / +185 °F
Fire resistance	No	
Halogen free	Yes (IEC 754-2)	

**FREQUENCY / ATTENUATION (typ. / 25 °C) / CW MAX POWER (sea level / 40 °C)**

GHz	dB / m	dB / ft	Watts
0.1	0.42	0.13	41
0.2	0.60	0.18	29
0.3	0.74	0.22	23
0.4	0.86	0.26	20
0.6	1.06	0.32	16
1.0	1.38	0.42	12
1.5	1.70	0.52	10
2.0	1.98	0.60	8
2.5	2.23	0.68	7
3.0	2.46	0.75	6
Attenuation calculation (dB/m)	[1.317 x √f GHz] + [0.06 x f GHz]		

<sup>(1)</sup> SPCCS = Silver Plated Copper covered steel<sup>(2)</sup> PE = PolyEthylene<sup>(3)</sup> SPC = Silver Plated Copper<sup>(4)</sup> LSZH PE = Low Smoke Zero Halogen PolyEthylene**Note:**

Typical attenuation for a couple of connectors [dB] = 0.045 x √f [GHz]

**Flexible cable 2.6/50 S (RG174 - KX3B)****P/N: C291 150 000  
(MIL-C-17/119-RG174)****P/N: C291 150 010  
(NF-C-93/550-KX3B)****APPLICATION NOTE**

For cost savings in low frequency applications, RG174 may be used instead of RG316 when environmental conditions like operating temperature allow it.

This cable is compatible with a large range of connector series.

Cost effective solution

**CONSTRUCTION / DIMENSIONS**

	Material	mm	Inches
Center conductor	Stranded CCS <sup>(1)</sup>	0.48	0.019
Dielectric	Solid PE <sup>(2)</sup>	1.52	0.060
Inner shield	TC <sup>(3)</sup> braid	2.21	0.087
Outer shield	-	-	-
Jacket	Black PVC <sup>(4)</sup>	2.79	0.110

**ELECTRICAL CHARACTERISTICS**

Characteristic impedance	50Ω ± 2Ω	
Operating frequency range	DC - 1 GHz	
Shielding effectiveness	40 dB	
Voltage withstanding	2 000 V rms	
Peak power	1.4 kW	
Capacitance	97.5 pF / m	29.5 pF / ft
Velocity of propagation	66 % [5 ns / m]	

**MECHANICAL CHARACTERISTICS**

Recommended minimum bending radius	10 mm	0.394 inch
Weight	13 g / m	0.0088 lbs / ft

**ENVIRONMENTAL CHARACTERISTICS**

Operating temperature range	-40 / +85 °C	-40 / +185 °F
Fire resistance	No	
Halogen free	No	

**FREQUENCY / ATTENUATION (typ.) / CW MAX POWER (sea level / 25 °C)**

GHz	dB / m	dB / ft	Watts
0.05	0.23	0.07	72
0.1	0.33	0.10	51
0.2	0.47	0.14	36
0.3	0.58	0.17	29
0.5	0.75	0.23	23
0.6	0.82	0.25	21
0.7	0.89	0.27	19
0.8	0.95	0.29	18
1.0	1.07	0.32	16
Attenuation calculation (dB/m)	[1.03 x √f GHz] + [0.04 x f GHz]		
Power calculation (W)	16 / √f GHz		

<sup>(1)</sup> CCS = Copper Covered Steel<sup>(2)</sup> PE = PolyEthylene<sup>(3)</sup> TC = Tinned Copper<sup>(4)</sup> PVC = PolyVinyl Chloride



## Flexible cable 2.6/50 S (RG316 - KX22A)



**P/N: C291 170 007  
(MIL-C-17/113-RG316)**

**P/N: C291 170 017  
(NF-C-93/550-KX22A)**

### APPLICATION NOTE

RG316 is one of the most popular RG cables. This cable has good flexibility and better attenuation than RG174. Suitable for severe thermal conditions, this cable is compatible with a large range of connector series.

### CONSTRUCTION / DIMENSIONS

	Material	mm	Inches
Center conductor	Stranded SPCCS <sup>(1)</sup>	0.53	0.021
Dielectric	Solid PTFE <sup>(2)</sup>	1.52	0.060
Inner shield	SPC <sup>(3)</sup> braid	1.98	0.078
Outer shield	-	-	-
Jacket	Brown FEP <sup>(4)</sup>	2.49	0.098

### ELECTRICAL CHARACTERISTICS

Characteristic impedance	50Ω ± 2Ω	
Operating frequency range	DC - 3 GHz	
Shielding effectiveness	40 dB	
Voltage withstanding	2 000 V rms	
Peak power	1.8 kW	
Capacitance	96 pF / m	29 pF / ft
Velocity of propagation	70 % (4.8 ns / m)	

### MECHANICAL CHARACTERISTICS

Recommended minimum bending radius	10 mm	0.394 inch
Weight	17 g / m	0.0110 lbs / ft

### ENVIRONMENTAL CHARACTERISTICS

Operating temperature range	-55 / +200 °C	-67 / +392 °F
Fire resistance	Yes (CSA FT6 / IEC 332-2)	
Halogen free	No	

### FREQUENCY / ATTENUATION (typ.) / CW MAX POWER (sea level / 25 °C)

GHz	dB / m	dB / ft	Watts
0.1	0.26	0.08	411
0.2	0.37	0.11	291
0.3	0.46	0.14	237
0.5	0.60	0.18	184
1.0	0.86	0.26	130
1.5	1.06	0.32	106
2.0	1.24	0.38	92
2.5	1.40	0.42	82
3.0	1.54	0.47	75
Attenuation calculation (dB/m)	[0.82 x √f GHz] + [0.04 x f GHz]		
Power calculation (W)	130 / √f GHz		

<sup>(1)</sup> SPCCS = Silver Plated Copper covered steel

<sup>(2)</sup> PTFE = PolyTetraFluoroEthylene

<sup>(3)</sup> SPC = Silver Plated Copper

<sup>(4)</sup> FEP = Fluorinated Ethylene Propylene

### Note:

Typical attenuation for a couple of connectors (dB) = 0.045 x √f (GHz)

## Flexible cable 2.6/50 D (RD316)



**P/N: C291 185 067**

### APPLICATION NOTE

Based on the RG 316 construction, RD316 has an outer shield braid which allows higher screening effectiveness and better mechanical resistance. Suitable for severe thermal conditions, this cable is compatible with a large range of connector series.

### CONSTRUCTION / DIMENSIONS

	Material	mm	Inches
Center conductor	Stranded SPC <sup>(1)</sup>	0.53	0.021
Dielectric	Solid PTFE <sup>(2)</sup>	1.52	0.060
Inner shield	SPC <sup>(1)</sup> braid	1.90	0.075
Outer shield	SPC <sup>(1)</sup> braid	2.30	0.091
Jacket	Brown FEP <sup>(3)</sup>	2.80	0.110

### ELECTRICAL CHARACTERISTICS

Characteristic impedance	50Ω ± 2Ω	
Operating frequency range	DC - 3 GHz	
Shielding effectiveness	60 dB	
Voltage withstanding	2 000 V rms	
Peak power	1.8 kW	
Capacitance	96 pF / m	29 pF / ft
Velocity of propagation	70 % (4.8 ns / m)	

### MECHANICAL CHARACTERISTICS

Recommended minimum bending radius	15 mm	0.590 inch
Weight	27 g / m	0.0181 lbs / ft

### ENVIRONMENTAL CHARACTERISTICS

Operating temperature range	-55 / +200 °C	-67 / +392 °F
Fire resistance	Yes (CSA FT6 / IEC 332-2)	
Halogen free	No	

### FREQUENCY / ATTENUATION (typ.) / CW MAX POWER (sea level / 25 °C)

GHz	dB / m	dB / ft	Watts
0.1	0.26	0.08	411
0.2	0.37	0.11	291
0.3	0.46	0.14	237
0.5	0.60	0.18	184
1.0	0.86	0.26	130
1.5	1.06	0.32	106
2.0	1.24	0.38	92
2.5	1.40	0.42	82
3.0	1.54	0.47	75
Attenuation calculation (dB/m)	[0.82 x √f GHz] + [0.04 x f GHz]		
Power calculation (W)	130 / √f GHz		

<sup>(1)</sup> SPC = Silver Plated Copper

<sup>(2)</sup> PTFE = PolyTetraFluoroEthylene

<sup>(3)</sup> FEP = Fluorinated Ethylene Propylene

## Flexible cable 2.6/75 S (RG179)



P/N: C291 210 007  
(MIL-C-17/94-RG179)

## APPLICATION NOTE

Due to its 75 ohms characteristic impedance, RG179 is dedicated to TV/Video application.

Its small internal stranded inner conductor diameter allows high flexibility for easy routing.

Suitable for severe thermal conditions.

## CONSTRUCTION / DIMENSIONS

	Material	mm	Inches
Center conductor	Stranded SPCCS <sup>(1)</sup>	0.30	0.012
Dielectric	Solid PTFE <sup>(2)</sup>	1.60	0.063
Inner shield	SPC <sup>(3)</sup> braid	2.00	0.079
Outer shield	-	-	-
Jacket	Brown FEP <sup>(4)</sup>	2.54	0.100

## ELECTRICAL CHARACTERISTICS

Characteristic impedance	75Ω ± 3Ω	
Operating frequency range	DC - 3 GHz	
Shielding effectiveness	40 dB	
Voltage withstanding	2 000 V rms	
Peak power	1.6 kW	
Capacitance	69 pF / m	21 pF / ft
Velocity of propagation	70 % (4.8 ns / m)	

## MECHANICAL CHARACTERISTICS

Recommended minimum bending radius	10 mm	0.400 inch
Weight	14.5 g / m	0.0097 lbs / ft

## ENVIRONMENTAL CHARACTERISTICS

Operating temperature range	-55 / +200 °C	-67 / +392 °F
Fire resistance	Yes (CSA FT6 / IEC 332-2)	
Halogen free	No	

FREQUENCY / ATTENUATION (typ.) /  
CW MAX POWER (sea level / 25 °C)

GHz	dB / m	dB / ft	Watts
0.1	0.29	0.09	791
0.2	0.41	0.13	559
0.3	0.51	0.15	456
0.5	0.66	0.20	354
1.0	0.95	0.29	250
1.5	1.17	0.36	204
2.0	1.37	0.41	117
2.5	1.54	0.47	158
3.0	1.70	0.51	144
Attenuation calculation (dB/m)	[0.91 x √f GHz] + [0.04 x f GHz]		
Power calculation (W)	250 / √f GHz		

<sup>(1)</sup> SPCCS = Silver Plated Copper Covered Steel

<sup>(2)</sup> PTFE = PolyTetraFluoroEthylene

<sup>(3)</sup> SPC = Silver Plated Copper

<sup>(4)</sup> FEP = Fluorinated Ethylene Propylene

## Note:

Typical attenuation for a couple of connectors (dB) = 0.045 x √f (GHz)

## Flexible cable 4.6/75 D (HD 0.6/2.8 - mini RG59 type)



P/N: C291 333 039

## APPLICATION NOTE

Due to its 75 ohms characteristic impedance, this cable is dedicated to HDTV/Video applications.

## CONSTRUCTION / DIMENSIONS

	Material	mm	Inches
Center conductor	Solid BC <sup>(1)</sup>	0.60	0.024
Dielectric	Foam PE <sup>(2)</sup>	2.80	0.110
Inner shield	Triplex tape Al <sup>(3)</sup> /PES <sup>(4)</sup> /Al	2.90	0.114
Outer shield	TC <sup>(5)</sup> braid	3.30	0.130
Jacket	Purple LSZH PE <sup>(6)</sup>	4.60	0.181

## ELECTRICAL CHARACTERISTICS

Characteristic impedance	75Ω ± 3Ω	
Operating frequency range	DC - 3 GHz	
Shielding effectiveness	-	
Voltage withstanding	1 500 V rms	
Peak power	-	
Capacitance	56 pF / m	17.07 pF / ft
Velocity of propagation	78 % (4.3 ns / m)	

## MECHANICAL CHARACTERISTICS

Recommended minimum bending radius	37 mm	1.46 inch
Weight	24 g / m	0.0161 lbs / ft

## ENVIRONMENTAL CHARACTERISTICS

Operating temperature range	-20 / +70 °C	-4 / +158 °F
Fire resistance	Yes (IEC 60332-1)	
Halogen free	Yes (IEC 60754-1 & -2)	

FREQUENCY / ATTENUATION (typ.) /  
CW MAX POWER (sea level / 25 °C)

GHz	dB / m	dB / ft	Watts
0.05	0.073	0.022	-
0.1	0.103	0.031	-
0.5	0.238	0.072	-
0.8	0.305	0.092	-
1.0	0.343	0.104	-
1.5	0.426	0.129	-
2.0	0.499	0.151	-
2.5	0.563	0.171	-
3.0	0.623	0.189	-
Attenuation calculation (dB/m)	[0.32 x √f GHz] + [0.023 x f GHz]		

<sup>(1)</sup> BC = Bare Copper

<sup>(2)</sup> PE = PolyEthylene

<sup>(3)</sup> Al = Aluminum

<sup>(4)</sup> PES = PolyESter

<sup>(5)</sup> TC = Tinned Copper

<sup>(6)</sup> LSZH PE = Low Smoke Zero Halogen PolyEthylene

## Flexible cable 5/50 S (RG58 - KX15)



**P/N: C291 305 000  
(MIL-C-17/28-RG58)**

**P/N: C291 305 010  
(NF-C-93/550-KX15)**

### APPLICATION NOTE

RG58 is one of the most popular RG cables. Due to its construction and raw material construction, RG58 / KX15 is designed to perform the same as 5/50 cables (RG142, RG223, EC0142)

This very flexible cable can be considered for applications requiring low electrical performance and reduced cost.

## CONSTRUCTION / DIMENSIONS

	Material	mm	Inches
Center conductor	Stranded TC <sup>(1)</sup>	0.90	0.035
Dielectric	Solid PE <sup>(2)</sup>	2.95	0.116
Inner shield	TC <sup>(1)</sup> braid	3.66	0.144
Outer shield	-	-	-
Jacket	Black PVC <sup>(3)</sup>	4.95	0.195

## ELECTRICAL CHARACTERISTICS

Characteristic impedance	50Ω ± 2Ω	
Operating frequency range	DC - 1 GHz	
Shielding effectiveness	40 dB	
Voltage withstanding	5 000 V rms	
Peak power	2.6 kW	
Capacitance	96 pF / m	29 pF / ft
Velocity of propagation	66 % [5 ns / m]	

## MECHANICAL CHARACTERISTICS

Recommended minimum bending radius	20 mm	0.787 inch
Weight	35 g / m	0.0234 lbs / ft

## ENVIRONMENTAL CHARACTERISTICS

Operating temperature range	-40 / +85 °C	-40 / +185 °F
Fire resistance	No	
Halogen free	No	

## FREQUENCY / ATTENUATION (typ.) / CW MAX POWER (sea level / 25 °C)

GHz	dB / m	dB / ft	Watts
0.05	0.14	0.04	246
0.1	0.20	0.06	174
0.2	0.29	0.09	123
0.3	0.36	0.11	100
0.5	0.47	0.14	78
0.6	0.51	0.16	71
0.7	0.56	0.17	66
0.8	0.60	0.18	61
1.0	0.67	0.20	55
Attenuation calculation (dB/m)	[0.63 x √f GHz] + [0.04 x f GHz]		
Power calculation (W)	55 / √f GHz		

<sup>(1)</sup> TC = Tinned Copper

<sup>(2)</sup> PE = PolyEthylene

<sup>(3)</sup> PVC = PolyVinyl Chloride

### Note:

Typical attenuation for a couple of connectors (dB) = 0.045 x √f (GHz)

## Flexible cable 5/50 D (RG142)



**P/N: C291 320 007  
(MIL-C-17/158-RG142)**

### APPLICATION NOTE

RG142 is one of the most popular RG cables. This cable offers a compromise between flexibility and electrical performances. RG142 will be selected among other 5/50 RG's for applications requiring high frequency range and low attenuation. Suitable for severe thermal conditions.

## CONSTRUCTION / DIMENSIONS

	Material	mm	Inches
Center conductor	Solid SPCCS <sup>(1)</sup>	0.94	0.037
Dielectric	Solid PTFE <sup>(2)</sup>	2.95	0.116
Inner shield	SPC <sup>(3)</sup> braid	-	-
Outer shield	SPC <sup>(3)</sup> braid	4.19	0.165
Jacket	Brown FEP <sup>(4)</sup>	4.95	0.195

## ELECTRICAL CHARACTERISTICS

Characteristic impedance	50Ω ± 2Ω	
Operating frequency range	DC - 12.4 GHz	
Shielding effectiveness	65 dB (DC - 3GHz)	
Voltage withstanding	5 000 V rms	
Peak power	3.4 kW	
Capacitance	97 pF / m	29.3 pF / ft
Velocity of propagation	70 % [4.8 ns / m]	

## MECHANICAL CHARACTERISTICS

Recommended minimum bending radius	25 mm	0.984 inch
Weight	64 g / m	0.043 lbs / ft

## ENVIRONMENTAL CHARACTERISTICS

Operating temperature range	-55 / +200 °C	-67 / +392 °F
Fire resistance	yes (CSA FT6 / IEC 332-2)	
Halogen free	No	

## FREQUENCY / ATTENUATION (typ.) / CW MAX POWER (sea level / 25 °C)

GHz	dB / m	dB / ft	Watts
0.5	0.30	0.09	665
1.0	0.44	0.13	470
1.5	0.55	0.17	384
2.0	0.65	0.20	332
3.0	0.81	0.25	271
6.0	1.22	0.37	192
8.0	1.45	0.44	166
10.0	1.66	0.50	149
12.4	1.90	0.58	133
Attenuation calculation (dB/m)	[0.40 x √f GHz] + [0.04 x f GHz]		
Power calculation (W)	470 / √f GHz		

<sup>(1)</sup> SPCCS = Silver Plated Copper Covered Steel

<sup>(2)</sup> PTFE = PolyTetraFluoroEthylene

<sup>(3)</sup> SPC = Silver Plated Copper

<sup>(4)</sup> FEP = Fluorinated Ethylene Propylene

## Flexible cable 5/50 D (RG223)



**P/N: C291 330 000  
(MIL-C-17/84-RG223)**

## APPLICATION NOTE

RG223 is one of the most popular RG cables. This cable is a good compromise between flexibility and electrical performance. RG223 can be used instead of RG142 to reduce cost in applications that do not require high temperature resistance.

## CONSTRUCTION / DIMENSIONS

	Material	mm	Inches
Center conductor	Solid SPC <sup>(1)</sup>	0.89	0.035
Dielectric	Solid PE <sup>(2)</sup>	2.95	0.116
Inner shield	SPC <sup>(1)</sup> braid	-	-
Outer shield	SPC <sup>(1)</sup> braid	4.19	0.165
Jacket	Black PVC <sup>(3)</sup>	5.38	0.212

## ELECTRICAL CHARACTERISTICS

Characteristic impedance	50Ω ± 2Ω	
Operating frequency range	DC - 12.4 GHz	
Shielding effectiveness	65 dB (DC - 3 GHz)	
Voltage withstanding	5 000 V rms	
Peak power	2.6 kW	
Capacitance	96 pF / m	29 pF / ft
Velocity of propagation	66 % [5 ns / m]	

## MECHANICAL CHARACTERISTICS

Recommended minimum bending radius	25 mm	0.984 inch
Weight	55 g / m	0.0370 lbs / ft

## ENVIRONMENTAL CHARACTERISTICS

Operating temperature range	-40 / +85 °C	-40 / +185 °F
Fire resistance	No	
Halogen free	No	

FREQUENCY / ATTENUATION (typ.) /  
CW MAX POWER (sea level / 25 °C)

GHz	dB / m	dB / ft	Watts
0.5	0.32	0.10	71
1.0	0.46	0.14	50
1.5	0.57	0.17	41
2.0	0.67	0.20	35
3.0	0.85	0.26	29
6.0	1.27	0.38	20
8.0	1.51	0.46	18
10.0	1.73	0.52	16
12.4	1.97	0.60	14
Attenuation calculation (dB/m)	[0.42 x √f GHz] + [0.04 x f GHz]		
Power calculation (W)	50 / √f GHz		

<sup>(1)</sup> SPC = Silver Plated Copper<sup>(2)</sup> PE = PolyEthylene<sup>(3)</sup> PVC = PolyVinyl Chloride

## Note:

Typical attenuation for a couple of connectors (dB) = 0.045 x √f (GHz)

## Flexible cable 5/50 D (RG400)



**P/N: C291 324 007  
(MIL-C-17/128-RG400)**

## APPLICATION NOTE

Due to its stranded inner conductor, RG 400 is much more flexible than RG142 and RG223. This cable can be used instead of equivalent RG's for specific applications requiring high flexibility. Suitable for severe thermal conditions.

## CONSTRUCTION / DIMENSIONS

	Material	mm	Inches
Center conductor	Stranded SPC <sup>(1)</sup>	0.98	0.039
Dielectric	Solid PTFE <sup>(2)</sup>	2.95	0.116
Inner shield	SPC <sup>(1)</sup> braid	-	-
Outer shield	SPC <sup>(1)</sup> braid	4.19	0.165
Jacket	Brown FEP <sup>(3)</sup>	4.95	0.195

## ELECTRICAL CHARACTERISTICS

Characteristic impedance	50Ω ± 2Ω	
Operating frequency range	DC - 12.4 GHz	
Shielding effectiveness	65 dB (DC - 3 GHz)	
Voltage withstanding	5 000 V rms	
Peak power	3.4 kW	
Capacitance	97 pF / m	29.3 pF / ft
Velocity of propagation	70 % [4.8 ns / m]	

## MECHANICAL CHARACTERISTICS

Recommended minimum bending radius	20 mm	0.79 inch
Weight	66 g / m	0.0442 lbs / ft

## ENVIRONMENTAL CHARACTERISTICS

Operating temperature range	-55 / +200 °C	-67 / +392 °F
Fire resistance	yes (CSA FT6 / IEC 332-2)	
Halogen free	No	

FREQUENCY / ATTENUATION (typ.) /  
CW MAX POWER (sea level / 25 °C)

GHz	dB / m	dB / ft	Watts
0.5	0.36	0.11	665
1.0	0.52	0.16	470
1.5	0.65	0.20	384
2.0	0.76	0.23	332
3.0	0.95	0.29	271
6.0	1.42	0.43	192
8.0	1.68	0.51	166
10.0	1.92	0.58	149
12.4	2.19	0.66	133
Attenuation calculation (dB/m)	[0.48 x √f GHz] + [0.04 x f GHz]		
Power calculation (W)	470 / √f GHz		

<sup>(1)</sup> SPC = Silver Plated Copper<sup>(2)</sup> PTFE = PolyTetraFluoroEthylene<sup>(3)</sup> FEP = Fluorinated Ethylene Propylene

## Flexible cable 5/50 D (KX23)



**P/N: C291 322 017  
(NF-C-93/550-KX23)**

### APPLICATION NOTE

Relevant standard: NF-C-93/550-KX23 (France)  
 Due to its stranded inner conductor it is much more flexible than RG142 or RG223.  
 This cable can be used instead of equivalent RG's for specific applications requiring high flexibility.  
 Suitable for severe thermal conditions.

### CONSTRUCTION / DIMENSIONS

	Material	mm	Inches
Center conductor	Stranded SPC <sup>(1)</sup>	0.92	0.036
Dielectric	Solid PTFE <sup>(2)</sup>	2.95	0.116
Inner shield	SPC braid	-	-
Outer shield	SPC braid	4.34	0.171
Jacket	Translucent fiber glass	5.10	0.201

### ELECTRICAL CHARACTERISTICS

Characteristic impedance	50Ω ± 2.5Ω	
Operating frequency range	DC - 8 GHz	
Shielding effectiveness	65 dB (DC - 3 GHz)	
Voltage withstanding	5 000 V rms	
Peak power	3 kW	
Capacitance	95 pF / m	28.8 pF / ft
Velocity of propagation	70 % [4.8 ns / m]	

### MECHANICAL CHARACTERISTICS

Recommended minimum bending radius	30 mm	1.181 inch
Weight	70 g / m	0.0466 lbs / ft

### ENVIRONMENTAL CHARACTERISTICS

Operating temperature range	-55 / +200 °C	-67 / +392 °F
Fire resistance	Yes (IEC 60332-1)	
Halogen free	No	

### FREQUENCY / ATTENUATION (typ. / 25 °C) / CW MAX POWER (sea level / 40 °C)

GHz	dB / m	dB / ft	Watts
0.5	0.33	0.10	375
1.0	0.48	0.14	260
1.5	0.60	0.18	210
2.0	0.70	0.21	180
2.5	0.80	0.24	160
3.0	0.89	0.27	146
4.0	1.05	0.32	126
5.0	1.20	0.37	112
6.0	1.35	0.41	102
8.0	1.61	0.49	88
Attenuation calculation (dB/m)	[0.427 x √f GHz] + [0.05 x f GHz]		

<sup>(1)</sup> SPC = Silver Plated Copper

<sup>(2)</sup> PTFE = PolyTetraFluoroEthylene

## Flexible cable 6/75 S (RG59)



**P/N: C291 360 000  
(MIL-C-17/29-RG59)**

### APPLICATION NOTE

Due to its 75 ohms characteristic impedance, RG59 is best suited for TV/ Video application.  
 Its solid inner conductor allows better attenuation than the equivalent KX solution (KX6).

### CONSTRUCTION / DIMENSIONS

	Material	mm	Inches
Center conductor	Solid CCS <sup>(1)</sup>	0.57	0.022
Dielectric	Solid PE <sup>(2)</sup>	3.71	0.146
Inner shield	Copper braid	4.50	0.177
Outer shield	-	-	-
Jacket	Black PVC <sup>(3)</sup>	6.15	0.242

### ELECTRICAL CHARACTERISTICS

Characteristic impedance	75Ω ± 3Ω	
Operating frequency range	DC - 1 GHz	
Shielding effectiveness	40 dB	
Voltage withstanding	7 000 V rms	
Peak power	2.7 kW	
Capacitance	60 pF / m	18.2 pF / ft
Velocity of propagation	66 % [5 ns / m]	

### MECHANICAL CHARACTERISTICS

Recommended minimum bending radius	30 mm	1.18 inch
Weight	47 g / m	0.0315 lbs / ft

### ENVIRONMENTAL CHARACTERISTICS

Operating temperature range	-40 / +85 °C	-40 / +185 °F
Fire resistance	No	
Halogen free	No	

### FREQUENCY / ATTENUATION (typ.) / CW MAX POWER (sea level / 25 °C)

GHz	dB / m	dB / ft	Watts
0.05	0.09	0.03	335
0.1	0.13	0.04	237
0.2	0.19	0.06	168
0.3	0.23	0.07	137
0.5	0.30	0.09	106
0.6	0.33	0.10	97
0.7	0.36	0.11	90
0.8	0.39	0.12	84
1.0	0.44	0.13	75
Attenuation calculation (dB/m)	[0.40 x √f GHz] + [0.04 x f GHz]		
Power calculation (W)	75 / √f GHz		

<sup>(1)</sup> CCS = Copper Covered Steel

<sup>(2)</sup> PE = PolyEthylene

<sup>(3)</sup> PVC = PolyVinyl Chloride

#### Note:

Typical attenuation for a couple of connectors (dB) = 0.045 x √f (GHz)

## Flexible cable 6/75 S (KX6A)



**P/N: C291 351 012**  
**(NF-C-93/550-KX6)**

**APPLICATION NOTE**

Relevant standard: NF-C-93/550-KX6 (France)

Due to its stranded inner conductor, KX6 is much more flexible than RG59.

This cable is better suited instead of RG59 for specific applications requiring high flexibility.

Cost effective solution

**CONSTRUCTION / DIMENSIONS**

	Material	mm	Inches
Center conductor	Stranded copper	0.60	0.024
Dielectric	Solid PE <sup>(1)</sup>	3.70	0.146
Inner shield	Copper braid	4.50	0.177
Outer shield	-	-	-
Jacket	Green PVC <sup>(2)</sup>	6.10	0.240

**ELECTRICAL CHARACTERISTICS**

Characteristic impedance	75Ω ± 3Ω	
Operating frequency range	DC - 1 GHz	
Shielding effectiveness	40 dB	
Voltage withstanding	7 000 V rms	
Peak power	2.7 kW	
Capacitance	63 pF / m	19 pF / ft
Velocity of propagation	66 % (5 ns / m)	

**MECHANICAL CHARACTERISTICS**

Recommended minimum bending radius	25 mm	0.98 inch
Weight	48 g / m	0.0320 lbs / ft

**ENVIRONMENTAL CHARACTERISTICS**

Operating temperature range	-40 / +85 °C	-40 / +185 °F
Fire resistance	No	
Halogen free	No	

**FREQUENCY / ATTENUATION (typ.) / CW MAX POWER (sea level / 25 °C)**

GHz	dB / m	dB / ft	Watts
0.05	0.10	0.03	300
0.1	0.14	0.04	212
0.2	0.20	0.06	150
0.3	0.25	0.08	122
0.5	0.33	0.10	95
0.6	0.36	0.11	86
0.7	0.40	0.12	80
0.8	0.43	0.13	75
1.0	0.48	0.15	67
Attenuation calculation (dB/m)	[0.44 x √f GHz] + [0.04 x f GHz]		
Power calculation (W)	67 / √f GHz		

<sup>(1)</sup> PE = PolyEthylene

<sup>(2)</sup> PVC = PolyVinyl Chloride

## Flexible cable 6/75 D (HD 0.8/3.7 - RG59 type)



**P/N: C291 360 093**

**APPLICATION NOTE**

Due to its 75 ohms characteristic impedance, this cable is best suited for HDTV/Video application.

**CONSTRUCTION / DIMENSIONS**

	Material	mm	Inches
Center conductor	Solid BC <sup>(1)</sup>	0.81	0.032
Dielectric	FHD PE <sup>(2)</sup>	3.68	0.145
Inner shield	Al <sup>(3)</sup> tape	3.81	0.150
Outer shield	TC <sup>(4)</sup> braid	4.37	0.172
Jacket	Blue PVC <sup>(5)</sup>	5.92	0.233

**ELECTRICAL CHARACTERISTICS**

Characteristic impedance	75Ω ± 1.5Ω	
Operating frequency range	DC - 4.5 GHz	
Shielding effectiveness	-	
Voltage withstanding	300 V rms	
Peak power	-	
Capacitance	53.5 pF / m	16.3 pF / ft
Velocity of propagation	83 % (4.0 ns / m)	

**MECHANICAL CHARACTERISTICS**

Recommended minimum bending radius	63.5 mm	2.5 inch
Weight	46 g / m	0.031 lbs / ft

**ENVIRONMENTAL CHARACTERISTICS**

Operating temperature range	-30 / +75 °C	-22 / +167 °F
Fire resistance	Yes (UL1666 Vertical Shaft)	
Halogen free	No	

**FREQUENCY / ATTENUATION (typ.) / CW MAX POWER (sea level / 25 °C)**

GHz	dB / m	dB / ft	Watts
0.5	0.173	0.052	-
1.0	0.247	0.075	-
1.5	0.304	0.092	-
2.0	0.353	0.107	-
2.5	0.397	0.120	-
3.0	0.437	0.132	-
3.5	0.473	0.143	-
4.0	0.508	0.154	-
4.5	0.541	0.164	-
Attenuation calculation (dB/m)	[0.24 x √f GHz] + [0.007 x f GHz]		

<sup>(1)</sup> BC = Bare Copper

<sup>(2)</sup> FHD PE = Foam High Density PolyEthylene

<sup>(3)</sup> Al = Aluminum

<sup>(4)</sup> TC = Tinned Copper

<sup>(5)</sup> PVC = PolyVinyl Chloride

**Note:**

Typical attenuation for a couple of connectors (dB) = 0.045 x √f (GHz)



## Flexible cable 7/75 D (HD 1.0/4.8 - RG6 type)



**P/N: C291 384 083**

### APPLICATION NOTE

Due to its 75 ohms characteristic impedance, this cable is better suited for HDTV/Video application.

### CONSTRUCTION / DIMENSIONS

	Material	mm	Inches
Center conductor	Solid BC <sup>(1)</sup>	1.02	0.040
Dielectric	FHD PE <sup>(2)</sup>	4.56	0.180
Inner shield	Al <sup>(3)</sup> tape	4.70	0.185
Outer shield	TC <sup>(4)</sup> braid	5.26	0.207
Jacket	Blue PVC <sup>(5)</sup>	6.95	0.274

### ELECTRICAL CHARACTERISTICS

Characteristic impedance	75Ω ± 1.5Ω	
Operating frequency range	DC - 4.5 GHz	
Shielding effectiveness	-	
Voltage withstanding	300 V rms	
Peak power	-	
Capacitance	53.15 pF / m	16.2 pF / ft
Velocity of propagation	82 % [4.1 ns / m]	

### MECHANICAL CHARACTERISTICS

Recommended minimum bending radius	69.85 mm	2.75 inch
Weight	59.5 g / m	0.04 lbs / ft

### ENVIRONMENTAL CHARACTERISTICS

Operating temperature range	-30 / +75 °C	-22 / +167 °F
Fire resistance	Yes [UL1666 Vertical Shaft]	
Halogen free	No	

### FREQUENCY / ATTENUATION (typ.) / CW MAX POWER (sea level / 25 °C)

GHz	dB / m	dB / ft	Watts
0.5	0.134	0.040	-
1.0	0.193	0.058	-
1.5	0.240	0.073	-
2.0	0.281	0.085	-
2.5	0.318	0.096	-
3.0	0.352	0.107	-
3.5	0.384	0.116	-
4.0	0.414	0.125	-
4.5	0.443	0.134	-
Attenuation calculation (dB/m)	[0.179 x √f GHz] + [0.014 x f GHz]		

<sup>(1)</sup> BC = Bare Copper

<sup>(2)</sup> FHD PE = Foam High Density PolyEthylene

<sup>(3)</sup> Al = Aluminum

<sup>(4)</sup> TC = Tinned Copper

<sup>(5)</sup> PVC = PolyVinyl Chloride

### Note:

Typical attenuation for a couple of connectors (dB) = 0.045 x √f (GHz)

## Flexible cable 10/50 S (RG213 - KX4)



**P/N: C291 510 000**

**(MIL-C-17/74-RG213)**

**P/N: C291 510 010**

**(NF-C-93/550-KX4)**

### APPLICATION NOTE

Due to its construction and raw material selection, RG213 is a cost effectiveness solution in the 10 mm cable range.

This cable may be considered for low frequency applications that do not require a high level of screening effectiveness.

Cost effective solution

### CONSTRUCTION / DIMENSIONS

	Material	mm	Inches
Center conductor	Standed copper	2.26	0.089
Dielectric	Solid PE <sup>(1)</sup>	7.24	0.285
Inner shield	Copper braid	8.13	0.320
Outer shield	-	-	-
Jacket	Black PVC <sup>(2)</sup>	10.30	0.406

### ELECTRICAL CHARACTERISTICS

Characteristic impedance	50Ω ± 2Ω	
Operating frequency range	DC - 1 GHz	
Shielding effectiveness	40 dB	
Voltage withstanding	10 000 V rms	
Peak power	6.5 kW	
Capacitance	96 pF / m	29 pF / ft
Velocity of propagation	66 % [5 ns / m]	

### MECHANICAL CHARACTERISTICS

Recommended minimum bending radius	40 mm	1.57 inch
Weight	148 g / m	0.0999 lbs / ft

### ENVIRONMENTAL CHARACTERISTICS

Operating temperature range	-40 / +85 °C	-40 / +185 °F
Fire resistance	No	
Halogen free	No	

### FREQUENCY / ATTENUATION (typ.) / CW MAX POWER (sea level / 25 °C)

GHz	dB / m	dB / ft	Watts
0.05	0.05	0.01	805
0.1	0.07	0.02	569
0.2	0.10	0.03	402
0.3	0.12	0.04	329
0.5	0.16	0.05	255
0.6	0.18	0.05	232
0.7	0.20	0.06	215
0.8	0.21	0.06	201
1.0	0.24	0.07	180
Attenuation calculation (dB/m)	[0.20 x √f GHz] + [0.04 x f GHz]		
Power calculation (W)	180 / √f GHz		

<sup>(1)</sup> PE = PolyEthylene

<sup>(2)</sup> PVC = PolyVinyl Chloride

## Flexible cable 10/50 D (RG393)



P/N: C291 511 007  
(MIL-C-17/174-RG393)

## APPLICATION NOTE

RG393 is one of the most popular RG cables.

This cable may be used for high frequency range and severe thermal conditions applications.

## CONSTRUCTION / DIMENSIONS

	Material	mm	Inches
Center conductor	Stranded SPC <sup>(1)</sup>	2.39	0.094
Dielectric	Solid PTFE <sup>(2)</sup>	7.24	0.285
Inner shield	SPC <sup>(1)</sup> braid	-	-
Outer shield	SPC <sup>(1)</sup> braid	8.90	0.350
Jacket	Brown FEP <sup>(3)</sup>	9.91	0.390

## ELECTRICAL CHARACTERISTICS

Characteristic impedance	50Ω ± 2Ω	
Operating frequency range	DC - 11 GHz	
Shielding effectiveness	65 dB (DC - 3 GHz)	
Voltage withstanding	10 000 V rms	
Peak power	8.3 kW	
Capacitance	96 pF / m	29 pF / ft
Velocity of propagation	70 % (4.8 ns / m)	

## MECHANICAL CHARACTERISTICS

Recommended minimum bending radius	40 mm	1.57 inch
Weight	235 g / m	0.1567 lbs / ft

## ENVIRONMENTAL CHARACTERISTICS

Operating temperature range	-55 / +200 °C	-67 / +392 °F
Fire resistance	Yes (CSA FT6 / IEC 332-2)	
Halogen free	No	

FREQUENCY / ATTENUATION (typ.) /  
CW MAX POWER (sea level / 25 °C)

GHz	dB / m	dB / ft	Watts
0.5	0.15	0.05	1 273
1.0	0.23	0.07	900
1.5	0.29	0.09	735
2.0	0.35	0.11	636
3.0	0.45	0.14	520
6.0	0.71	0.21	367
8.0	0.86	0.26	318
10.0	1.00	0.30	285
11.0	1.07	0.32	271
Attenuation calculation (dB/m)	[0.19 x √f GHz] + [0.04 x f GHz]		
Power calculation (W)	900 / √f GHz		

<sup>(1)</sup> SPC = Silver Plated Copper

<sup>(2)</sup> PTFE = PolyTetraFluoroEthylene

<sup>(3)</sup> FEP = Fluorinated Ethylene Propylene

## Note:

Typical attenuation for a couple of connectors (dB) = 0.045 x √f (GHz)

## Flexible cable 11/50 D (RG214 - KX13)



P/N: C291 600 000  
(MIL-C-17/75-RG214)

P/N: C291 600 010  
(NF-C-93/550-KX13)

## APPLICATION NOTE

RG214 is one of the most popular RG cables.

To reduce cost when thermal conditions allow this cable may be used instead of RG393.

## CONSTRUCTION / DIMENSIONS

	Material	mm	Inches
Center conductor	Stranded SPC <sup>(1)</sup>	2.25	0.089
Dielectric	Solid PE <sup>(2)</sup>	7.24	0.285
Inner shield	SPC <sup>(1)</sup> braid	-	-
Outer shield	SPC <sup>(1)</sup> braid	8.89	0.350
Jacket	Black PVC <sup>(3)</sup>	10.80	0.425

## ELECTRICAL CHARACTERISTICS

Characteristic impedance	50Ω ± 2Ω	
Operating frequency range	DC - 11 GHz	
Shielding effectiveness	65 dB (DC - 3 GHz)	
Voltage withstanding	10 000 V rms	
Peak power	6.5 kW	
Capacitance	96 pF / m	29 pF / ft
Velocity of propagation	66 % (5 ns / m)	

## MECHANICAL CHARACTERISTICS

Recommended minimum bending radius	40 mm	1.57 inch
Weight	174 g / m	0.1170 lbs / ft

## ENVIRONMENTAL CHARACTERISTICS

Operating temperature range	-40 / +85 °C	-40 / +185 °F
Fire resistance	No	
Halogen free	No	

FREQUENCY / ATTENUATION (typ.) /  
CW MAX POWER (sea level / 25 °C)

GHz	dB / m	dB / ft	Watts
0.5	0.16	0.05	255
1.0	0.24	0.07	180
1.5	0.30	0.09	147
2.0	0.36	0.11	127
3.0	0.47	0.14	104
6.0	0.73	0.22	73
8.0	0.89	0.27	64
10.0	1.03	0.31	57
11.0	1.10	0.33	54
Attenuation calculation (dB/m)	[0.20 x √f GHz] + [0.04 x F GHz]		
Power calculation (W)	180 / √f GHz		

<sup>(1)</sup> SPC = Silver Plated Copper

<sup>(2)</sup> PE = PolyEthylene

<sup>(3)</sup> PVC = PolyVinyl Chloride



## Flexible cable 11/75 D (RG216)



**P/N: C291 610 000  
(MIL-C-17/77-RG216)**

### APPLICATION NOTE

Due to its 75 ohms characteristic impedance, RG 216 is better suited for TV/Video applications.

## CONSTRUCTION / DIMENSIONS

	Material	mm	Inches
Center conductor	Stranded TC <sup>(1)</sup>	1.21	0.048
Dielectric	Solid PE <sup>(2)</sup>	7.24	0.285
Inner shield	Copper braid	-	-
Outer shield	Copper braid	8.89	0.350
Jacket	Black PVC <sup>(3)</sup>	10.80	0.425

## ELECTRICAL CHARACTERISTICS

Characteristic impedance	75Ω ± 3Ω	
Operating frequency range	DC - 3 GHz	
Shielding effectiveness	65 dB	
Voltage withstanding	10 000 V rms	
Peak power	5.3 kW	
Capacitance	66 pF / m	20 pF / ft
Velocity of propagation	66 % (5 ns / m)	

## MECHANICAL CHARACTERISTICS

Recommended minimum bending radius	50 mm	1.97 inch
Weight	165 g / m	0.1104 lbs / ft

## ENVIRONMENTAL CHARACTERISTICS

Operating temperature range	-40 / +85 °C	-40 / +185 °F
Fire resistance	No	
Halogen free	No	

## FREQUENCY / ATTENUATION (typ.) / CW MAX POWER (sea level / 25 °C)

GHz	dB / m	dB / ft	Watts
0.1	0.09	0.03	395
0.2	0.13	0.04	280
0.3	0.17	0.05	228
0.5	0.22	0.07	177
1.0	0.32	0.10	125
1.5	0.40	0.12	102
2.0	0.48	0.14	88
2.5	0.54	0.16	79
3.0	0.60	0.18	72
Attenuation calculation (dB/m)	[0.28 x √f GHz] + [0.04 x f GHz]		
Power calculation (W)	125 / √f GHz		

<sup>(1)</sup> TC = Tinned Copper

<sup>(2)</sup> PE = PolyEthylene

<sup>(3)</sup> PVC = PolyVinyl Chloride

### Note:

Typical attenuation for a couple of connectors (dB) = 0.045 x √f (GHz)

## Flexible cable 2.6/50 S (ECO316: alternative to RG316)



**P/N: C291 999 904**

### APPLICATION NOTE

Designed by RADIALL, ECO316 is an advantageous alternative solution to RG316:

- **Advantageous in term of electrical performance:** its optimized construction allows better attenuation and screening effectiveness than RG316 and RG 174.

- **Environmental advantages:** halogen and sulphur free, this cable does not emit any toxic substance when submitted to fire. The flame retardant jacket allows ECO316 to meet fire resistance standards.

- **Advantageous in term of price:** ECO316 design has integrated all Radiall knowledge to reach the best performance with a very competitive price.

ECO316 is UL style 1375 approved.

**This cable is compatible with a large range of connector series.**

ECO-Friendly cable  
Cost effective solution

## CONSTRUCTION / DIMENSIONS

	Material	mm	Inches
Center conductor	Solid OFC <sup>(1)</sup>	0.55	0.022
Dielectric	Foam PE <sup>(2)</sup>	1.55	0.061
Inner shield	OFC <sup>(1)</sup> braid	1.90	0.075
Outer shield	-	-	-
Jacket	Black LSZH PE <sup>(3)</sup>	2.45	0.096

## ELECTRICAL CHARACTERISTICS

Characteristic impedance	50Ω ± 2Ω	
Operating frequency range	DC - 3 GHz	
Shielding effectiveness	50 dB	
Voltage withstanding	2 000 V rms	
Peak power	1.4 kW	
Capacitance	84 pF / m	25.5 pF / ft
Velocity of propagation	80 % (4.15 ns / m)	

## MECHANICAL CHARACTERISTICS

Recommended minimum bending radius	15 mm	0.590 inch
Weight	10 g / m	0.0066 lbs / ft

## ENVIRONMENTAL CHARACTERISTICS

Operating temperature range	-40 / +85 °C	-40 / +185 °F
Fire resistance	Yes (UL1581 VW1 / IEC 332-1)	
Halogen free	Yes (IEC 754-2)	

## FREQUENCY / ATTENUATION (typ.) / CW MAX POWER (sea level / 25 °C)

GHz	dB / m	dB / ft	Watts
0.1	0.24	0.07	120
0.2	0.33	0.10	85
0.3	0.41	0.12	69
0.5	0.53	0.16	54
1.0	0.76	0.23	38
1.5	0.94	0.28	31
2.0	1.09	0.33	27
2.5	1.22	0.37	24
3.0	1.34	0.41	22
Attenuation calculation (dB/m)	[0.74 x √f GHz] + [0.02 x f GHz]		
Power calculation (W)	38 / √f GHz		

<sup>(1)</sup> OFC = Oxygen Free Copper

<sup>(2)</sup> PE = PolyEthylene

<sup>(3)</sup> LSZH PE = Low Smoke Zero Halogen PolyEthylene

## Flexible cable 2.6/50 S (ECO316X)



ECO-Friendly cable  
Cost effective solution

P/N: C291 171 083

## APPLICATION NOTE

Designed by Radiall, ECO316X is an alternative solution to ECO316 when higher power level is required:

- **Advantageous in term of electrical performance:** the crosslink foam polyethylene used as dielectric material allows higher temperature level (thus power range) than ECO316.
  - **Environmental advantages:** halogen and sulphur free, this cable does not emit any toxic substance when submitted to fire. The flame retardant jacket allows ECO316X to meet fire resistance standards.
  - **Advantageous in term of price:** ECO316X design has integrated all Radiall knowledge to reach the best performance with a very competitive price.
- ECO316X is UL style 1375 and 3651 approved  
This cable is compatible with a large range of standard connector series.

## Flexible cable 2.6/50 D (ECO316D: alternative to RD316)



ECO-Friendly cable  
Cost effective solution

P/N: C291 999 905

## APPLICATION NOTE

Designed by Radiall, ECO316D is an alternative solution to RD316:

- **Advantageous in term of electrical performance:** its optimized construction allows better attenuation and screening effectiveness than RD316.
  - **Environmental advantages:** halogen and sulphur free, this cable does not emit any toxic substance when submitted to fire. The flame retardant jacket allows ECO316D to meet fire resistance standards.
  - **Advantageous in term of price:** ECO316D design has integrated all Radiall knowledge to reach the best performance with a very competitive price.
- ECO316D is UL style 1375 approved.  
This cable is compatible with a large range of connector series.

## CONSTRUCTION / DIMENSIONS

	Material	mm	Inches
Center conductor	Stranded SPC <sup>(1)</sup>	0.54	0.021
Dielectric	X foam PE <sup>(2)</sup>	1.54	0.061
Inner shield	SPC <sup>(1)</sup> braid	2.05	0.081
Jacket	Blue LSZH PE <sup>(3)</sup>	2.52	0.099

## ELECTRICAL CHARACTERISTICS

Characteristic impedance	50Ω ± 2Ω
Operating frequency range	DC - 3 GHz
Shielding effectiveness	35 dB
Voltage withstanding	3 000 V rms
Capacitance	94.5 pF / m      28.7 pF / ft
Velocity of propagation	71 % (4.7 ns / m)

## MECHANICAL CHARACTERISTICS

Recommended minimum bending radius	5 mm	0.197 inch
Weight	16 g / m	0.011 lbs / ft

## ENVIRONMENTAL CHARACTERISTICS

Operating temperature range	-40 / +105 °C	-40 / +221 °F
Fire resistance	Yes (UL1581 VW1 / IEC 332-1)	
Halogen free	Yes (IEC 754-2)	

FREQUENCY / ATTENUATION (typ.) /  
CW MAX POWER (sea level / 20 °C)

GHz	dB / m	dB / ft	Watts
0.1	0.27	0.08	285
0.3	0.49	0.15	164
0.5	0.65	0.20	127
0.6	0.72	0.22	116
0.8	0.84	0.26	101
1.0	0.96	0.29	90
1.5	1.22	0.37	73
2.0	1.45	0.44	64
2.5	1.66	0.50	57
3.0	1.85	0.56	52
Attenuation calculation (dB/m)	[0.81 x √f GHz] + [0.15 x f GHz]		
Power calculation (W)	90 / √f GHz		

<sup>(1)</sup> SPC = Silver Plated Copper

<sup>(2)</sup> X foam PE = Crosslink foam PolyEthylene

<sup>(3)</sup> LSZH PE = Low Smoke Zero Halogen PolyEthylene

## Note:

Typical attenuation for a couple of connectors (dB) = 0.045 x √f (GHz)

## CONSTRUCTION / DIMENSIONS

	Material	mm	Inches
Center conductor	Solid OFC <sup>(1)</sup>	0.55	0.022
Dielectric	Foam PE <sup>(2)</sup>	1.55	0.061
Inner shield	OFC <sup>(1)</sup> braid	1.90	0.075
Outer shield	OFC <sup>(1)</sup> braid	2.30	0.091
Jacket	Black LSZH PE <sup>(3)</sup>	2.80	0.110

## ELECTRICAL CHARACTERISTICS

Characteristic impedance	50Ω ± 2Ω
Operating frequency range	DC - 3 GHz
Shielding effectiveness	65 dB
Voltage withstanding	2 000 V rms
Peak power	1.4 kW
Capacitance	84 pF / m      25.5 pF / ft
Velocity of propagation	80 % (4.15 ns / m)

## MECHANICAL CHARACTERISTICS

Recommended minimum bending radius	15 mm	0.590 inch
Weight	16 g / m	0.0106 lbs / ft

## ENVIRONMENTAL CHARACTERISTICS

Operating temperature range	-40 / +85 °C	-40 / +185 °F
Fire resistance	Yes (UL 1581 VW1 / IEC 332-1)	
Halogen free	Yes (IEC 754-2)	

FREQUENCY / ATTENUATION (typ.) /  
CW MAX POWER (sea level / 25 °C)

GHz	dB / m	dB / ft	Watts
0.1	0.24	0.07	120
0.2	0.33	0.10	85
0.3	0.41	0.12	69
0.5	0.53	0.16	54
1.0	0.76	0.23	38
1.5	0.94	0.28	31
2.0	1.09	0.33	27
2.5	1.22	0.37	24
3.0	1.34	0.41	22
Attenuation calculation (dB/m)	[0.74 x √f GHz] + [0.02 x f GHz]		
Power calculation (W)	38 / √f GHz		

<sup>(1)</sup> OFC = Oxygen Free Copper

<sup>(2)</sup> PE = PolyEthylene

<sup>(3)</sup> LSZH PE = Low Smoke Zero Halogen PolyEthylene

## Flexible cable 2.6/50 D (ECO316DX)



ECO-Friendly cable  
Cost effective solution

P/N: C291 217 020

### APPLICATION NOTE

Designed by Radiall, ECO316DX is an alternative solution to ECO316D when higher power level is required:

- **Advantageous in term of electrical performance:** the crosslink foam polyethylene used as dielectric material allows higher temperature level (thus power range) than ECO316D.
- **Environmental advantages:** halogen and sulphur free, this cable does not emit any toxic substance when submitted to fire. The flame retardant jacket allows ECO316DX to meet fire resistance standards.
- **Advantageous in term of price:** ECO316DX design has integrated all Radiall knowledge to reach the best performance with a very competitive price. ECO316DX is UL style 1375 and 3651 approved. **This cable is compatible with a large range of standard connector series.**

## CONSTRUCTION / DIMENSIONS

	Material	mm	Inches
Center conductor	Stranded SPC <sup>(1)</sup>	0.54	0.021
Dielectric	X foam PE <sup>(2)</sup>	1.54	0.061
Inner shield	SPC <sup>(1)</sup> braid	2.03	0.080
Outer shield	SPC <sup>(1)</sup> braid	2.50	0.098
Jacket	Black with blue stripe LSZH PE <sup>(3)</sup>	3.16	0.124

## ELECTRICAL CHARACTERISTICS

Characteristic impedance	50Ω ± 2Ω	
Operating frequency range	DC - 6 GHz	
Shielding effectiveness	70 dB (DC - 5 GHz)	
Voltage withstanding	1 500 V rms	
Capacitance	94.5 pF / m	28.7 pF / ft
Velocity of propagation	71 % (4.7 ns / m)	

## MECHANICAL CHARACTERISTICS

Recommended minimum bending radius	5 mm	0.196 inch
Weight	21 g / m	0.0140 lbs / ft

## ENVIRONMENTAL CHARACTERISTICS

Operating temperature range	-40 / +105 °C	-40 / +221 °F
Fire resistance	Yes (UL1581 VW1 / IEC 332-1)	
Halogen free	Yes (IEC 754-2)	

## FREQUENCY / ATTENUATION (typ.) / CW MAX POWER (sea level / 25 °C)

GHz	dB / m	dB / ft	Watts
0.5	0.58	0.17	127
1.0	0.86	0.26	90
1.5	1.09	0.33	73
2.0	1.30	0.40	64
2.5	1.50	0.45	57
3.0	1.68	0.51	52
3.5	1.85	0.56	48
4.0	2.02	0.61	45
5.0	2.34	0.71	40
6.0	2.64	0.80	37
Attenuation calculation (dB/m)	[0.71 x √f GHz] + [0.15 x f GHz]		
Power calculation (W)	90 / √f GHz		

<sup>(1)</sup> SPC = Silver Plated Copper

<sup>(2)</sup> X foam PE = Crosslink foam PolyEthylene

<sup>(3)</sup> LSZH PE = Low Smoke Zero Halogen PolyEthylene

### Note:

Typical attenuation for a couple of connectors (dB) = 0.045 x √f (GHz)

## Flexible cable 5/50 D (ECO142: alternative to RG142)



ECO-Friendly cable  
Cost effective solution

P/N: C291 325 290

### APPLICATION NOTE

Designed by Radiall, ECO142 is an alternative solution to RG142:

- **Advantageous in term of electrical performance:** its optimized construction allows better attenuation and screening effectiveness than RG142.
- **Environmental advantages:** halogen and sulphur free, this cable does not emit any toxic substance when submitted to fire. The flame retardant jacket allows ECO142 to meet fire resistance standards.
- **Advantageous in term of price:** ECO142 design has integrated all Radiall knowledge to reach the best performance with a very competitive price. ECO142 is UL style 1375 approved. **This cable is compatible with a large range of connector series.**

## CONSTRUCTION / DIMENSIONS

	Material	mm	Inches
Center conductor	Solid OFC <sup>(1)</sup> copper	0.95	0.037
Dielectric	Foam PE <sup>(2)</sup>	2.85	0.112
Inner shield	Al <sup>(3)</sup> foil	3.10	0.122
Outer shield	TC <sup>(4)</sup> braid	3.50	0.138
Jacket	Black LSZH PE <sup>(5)</sup>	4.50	0.177

## ELECTRICAL CHARACTERISTICS

Characteristic impedance	50Ω ± 2Ω	
Operating frequency range	DC - 3 GHz	
Shielding effectiveness	80 dB (DC - 3 GHz)	
Voltage withstanding	5 000 V rms	
Peak power	2.7 kW	
Capacitance	87 pF / m	26.4 pF / ft
Velocity of propagation	77 % (4.3 ns / m)	

## MECHANICAL CHARACTERISTICS

Recommended minimum bending radius	15 mm	0.590 inch
Weight	36 g / m	0.0242 lbs / ft

## ENVIRONMENTAL CHARACTERISTICS

Operating temperature range	-40 / +85 °C	-40 / +185 °F
Fire resistance	Yes (UL1581 VW1 / IEC 332-1)	
Halogen free	Yes (IEC 754-2)	

## FREQUENCY / ATTENUATION (typ.) / CW MAX POWER (sea level / 25 °C)

GHz	dB / m	dB / ft	Watts
0.1	0.12	0.04	411
0.2	0.18	0.05	291
0.3	0.22	0.07	237
0.5	0.28	0.09	184
1.0	0.41	0.12	130
1.5	0.50	0.15	106
2.0	0.58	0.18	92
2.5	0.66	0.20	82
3.0	0.73	0.22	75
Attenuation calculation (dB/m)	[0.385 x √f GHz] + [0.02 x f GHz]		
Power calculation (W)	130 / √f GHz		

<sup>(1)</sup> OFC = Oxygen Free Copper

<sup>(2)</sup> PE = PolyEthylene

<sup>(3)</sup> Al = Aluminum

<sup>(4)</sup> TC = Tinned Copper

<sup>(5)</sup> LSZH PE = Low Smoke Zero Halogen PolyEthylene

## Flexible cable 5/50 D (ECO142X)



ECO-Friendly cable  
Cost effective solution

P/N: C291 320 180

## APPLICATION NOTE

Designed by Radiall, ECO142X is an alternative solution to ECO142 when higher power level is required:

- **Advantageous in term of electrical performance:** the crosslink foam polyethylene used as dielectric material allows higher temperature level (thus power range) than ECO142.
- **Environmental advantages:** halogen and sulphur free, this cable does not emit any toxic substance when submitted to fire. The flame retardant jacket allows ECO142X to meet fire resistance standards.
- **Advantageous in term of price:** ECO142X design has integrated all Radiall knowledge to reach the best performance with a very competitive price. ECO142X is UL style 1375 and 3651 approved. This cable is compatible with a large range of standard connector series.

## Flexible cable 5/50 D (Power 142: alternative to RG142)



P/N: C291 325 270

## APPLICATION NOTE

Designed by Radiall, POWER142 is an alternative solution to ECO142 when high power level is required:

- **Advantageous in term of electrical performance:** its optimized construction allows better attenuation and screening effectiveness than RG142 and higher power level than ECO142.
- **Environmental advantages:** the flame retardant jacket allows POWER142 to meet fire resistance standards.
- **Advantageous in term of price:** POWER142 design has integrated all Radiall knowledge to reach the best performance with a very competitive price. POWER142 is UL style 1375 approved. This cable is compatible with a large range of connector series.

## CONSTRUCTION / DIMENSIONS

	Material	mm	inches
Center conductor	Solid SPC <sup>(1)</sup>	0.95	0.037
Dielectric	X foam PE <sup>(2)</sup>	2.98	0.117
Inner shield	SPC <sup>(1)</sup> braid	3.64	0.143
Outer shield	SPC <sup>(1)</sup> braid	4.30	0.169
Jacket	Black with blue stripe LSZH PE <sup>(3)</sup>	5.00	0.197

## CONSTRUCTION / DIMENSIONS

	Material	mm	Inches
Center conductor	Solid SPC <sup>(1)</sup>	0.92	0.036
Dielectric	Solid PTFE <sup>(2)</sup>	2.97	0.117
Inner shield	Al <sup>(3)</sup> foil	3.20	0.126
Outer shield	TC <sup>(4)</sup> braid	3.60	0.142
Jacket	Black LSZH PE <sup>(5)</sup>	4.50	0.177

## ELECTRICAL CHARACTERISTICS

Characteristic impedance	50Ω ± 2Ω	
Operating frequency range	DC - 6 GHz	
Shielding effectiveness	75 dB (DC - 5 GHz)	
Voltage withstanding	5 000 V rms	
Capacitance	94.5 pF / m	28.7 pF / ft
Velocity of propagation	71 % (4.7 ns / m)	

## ELECTRICAL CHARACTERISTICS

Characteristic impedance	50Ω ± 2Ω	
Operating frequency range	DC - 3 GHz	
Shielding effectiveness	90 dB (DC - 3 GHz)	
Voltage withstanding	5 000 V rms	
Peak power	3.4 kW	
Capacitance	97 pF / m	29.3 pF / ft
Velocity of propagation	69 % (4.8 ns / m)	

## MECHANICAL CHARACTERISTICS

Recommended minimum bending radius	30 mm	1.18 inch
Weight	60 g / m	0.0433 lbs / ft

## MECHANICAL CHARACTERISTICS

Recommended minimum bending radius	25 mm	0.980 inch
Weight	40 g / m	0.0269 lbs / ft

## ENVIRONMENTAL CHARACTERISTICS

Operating temperature range	-40 / +105 °C	-40 / +221 °F
Fire resistance	Yes (UL1581 VW1 / IEC 332-1)	
Halogen free	Yes (IEC 754-2)	

## ENVIRONMENTAL CHARACTERISTICS

Operating temperature range	-40 / +105 °C	-40 / +221 °F
Fire resistance	Yes (UL1581 VW1 / IEC 332-1)	
Halogen free	No	

FREQUENCY / ATTENUATION (typ.) /  
CW MAX POWER (sea level / 25 °C)

GHz	dB / m	dB / ft	Watts
0.5	0.36	0.11	354
1.0	0.54	0.16	250
1.5	0.69	0.21	204
2.0	0.83	0.25	177
2.5	0.95	0.29	158
3.0	1.07	0.32	144
3.5	1.18	0.36	134
4.0	1.29	0.39	125
5.0	1.50	0.45	112
6.0	1.70	0.51	102
Attenuation calculation (dB/m)	[0.44 x √f GHz] + [0.103 x f GHz]		
Power calculation (W)	250 / √f GHz		

FREQUENCY / ATTENUATION (typ.) /  
CW MAX POWER (sea level / 40 °C)

GHz	dB / m	dB / ft	Watts
0.2	0.18	0.05	470
0.4	0.26	0.08	332
0.6	0.32	0.10	271
0.8	0.37	0.11	235
1.0	0.41	0.12	210
1.5	0.50	0.15	171
2.0	0.58	0.18	148
2.5	0.66	0.20	133
3.0	0.72	0.22	121
Attenuation calculation (dB/m)	[0.402 x √f GHz] + [0.008 x f GHz]		
Power calculation (W)	210 / √f GHz		

<sup>(1)</sup> SPC = Silver Plated Copper

<sup>(2)</sup> X foam PE = Crosslink foam PolyEthylene

<sup>(3)</sup> LSZH PE = Low Smoke Zero Halogen PolyEthylene

## Note:

Typical attenuation for a couple of connectors (dB) = 0.045 x √f (GHz)

<sup>(1)</sup> SPC = Silver Plated Copper

<sup>(2)</sup> PTFE = PolyTetraFluoroEthylene

<sup>(3)</sup> Al = Aluminum

<sup>(4)</sup> TC = Tinned Copper

<sup>(5)</sup> LSZH PE = Low Smoke Zero Halogen PolyEthylene

## Flexible cable 6/50 D (ECO230)



**P/N: C291 326 490**

### APPLICATION NOTE

Designed by Radiall, ECO230 is an alternative solution to 5 mm dia. cables when higher power level is required:

- **Advantageous in term of electrical performance:** its optimized construction allows better attenuation and screening effectiveness than RG cables.
- **Environmental advantages:** halogen and sulphur free, this cable does not emit any toxic substance when submitted to fire. The flame retardant jacket allows ECO230 to meet fire resistance standards.
- **Advantageous in term of price:** ECO230 design has integrated all Radiall knowledge to reach the best performance with a very competitive price. ECO230 is UL style 1375 approved.

## CONSTRUCTION / DIMENSIONS

	Material	mm	Inches
Center conductor	OFC <sup>(1)</sup> copper	1.46	0.057
Dielectric	Foam PE <sup>(2)</sup>	4.07	0.160
Inner shield	Al <sup>(3)</sup> foil	4.27	0.168
Outer shield	TC <sup>(4)</sup> braid	4.75	0.187
Jacket	Black LSZH <sup>(5)</sup> PE	5.90	0.232

## ELECTRICAL CHARACTERISTICS

Characteristic impedance	50Ω ± 2Ω	
Operating frequency range	DC - 4 GHz	
Shielding effectiveness	90 dB (DC - 3 GHz)	
Voltage withstanding	3 000 V rms	
Peak power	3.3 kW	
Capacitance	84 pF / m	25.5 pF / ft
Velocity of propagation	79 % (4.2 ns / m)	

## MECHANICAL CHARACTERISTICS

Recommended minimum bending radius	25 mm	0.98 inch
Weight	62 g / m	0.0417 lbs / ft

## ENVIRONMENTAL CHARACTERISTICS

Operating temperature range	-40 / +85 °C	-40 / +185 °F
Fire resistance	Yes (UL1581 VW1 / IEC 332-1)	
Halogen free	Yes (IEC 754-2)	

## FREQUENCY / ATTENUATION (typ.) / CW MAX POWER (sea level / 40 °C)

GHz	dB / m	dB / ft	Watts
0.2	0.12	0.04	391
0.4	0.17	0.05	277
0.6	0.21	0.06	226
0.8	0.25	0.08	196
1.0	0.28	0.08	175
1.5	0.35	0.10	143
2.0	0.40	0.12	124
2.5	0.45	0.14	111
3.0	0.50	0.15	101
4.0	0.59	0.18	88
Attenuation calculation (dB/m)	[0.264 x √f GHz] + [0.015 x f GHz]		
Power calculation (W)	175 / √f GHz		

<sup>(1)</sup> OFC = Oxygen Free Copper

<sup>(2)</sup> PE = PolyEthylene

<sup>(3)</sup> Al = Aluminum

<sup>(4)</sup> TC = Tinned Copper

<sup>(5)</sup> LSZH PE = Low Smoke Zero Halogen PolyEthylene

### Note:

Typical attenuation for a couple of connectors (dB) = 0.045 x √f (GHz)

## Flexible cable 10/50 D (ECO393: alternative to RG393)



**P/N: C291 491 060**

### APPLICATION NOTE

Designed by Radiall, ECO393 is an alternative solution to RG393:

- **Advantageous in term of electrical performance:** its optimized construction allows better attenuation and screening effectiveness than RG393
- **Environmental advantages:** halogen and sulphur free, this cable does not emit any toxic substance when submitted to fire. The flame retardant jacket allows ECO393 to meet fire resistance standards.
- **Advantageous in term of price:** ECO393 design has integrated all Radiall knowledge to reach the best performance with a very competitive price. ECO393 is UL style 1375 approved. This cable is compatible with a large range of connector series.

ECO-Friendly cable  
Cost effective solution

## CONSTRUCTION / DIMENSIONS

	Material	mm	Inches
Center conductor	Solid OFC <sup>(1)</sup>	2.40	0.094
Dielectric	Foam PE <sup>(2)</sup>	7.25	0.285
Inner shield	Al <sup>(3)</sup> foil	7.35	0.289
Outer shield	TC <sup>(4)</sup> braid	7.85	0.309
Jacket	Black LSZH PE <sup>(5)</sup>	9.10	0.358

## ELECTRICAL CHARACTERISTICS

Characteristic impedance	50Ω ± 2Ω	
Operating frequency range	DC - 3 GHz	
Shielding effectiveness	80 dB (DC - 3 GHz)	
Voltage withstanding	10 000 V rms	
Peak power	6.6 kW	
Capacitance	88 pF / m	26.6 pF / ft
Velocity of propagation	75 % (4.4 ns / m)	

## MECHANICAL CHARACTERISTICS

Recommended minimum bending radius	40 mm	1.57 inch
Weight	130 g / m	0.0875 lbs / ft

## ENVIRONMENTAL CHARACTERISTICS

Operating temperature range	-40 / +85 °C	-40 / +185 °F
Fire resistance	Yes (UL1581 VW1 / IEC 332-1)	
Halogen free	Yes (IEC 754-2)	

## FREQUENCY / ATTENUATION (typ.) / CW MAX POWER (sea level / 25 °C)

GHz	dB / m	dB / ft	Watts
0.1	0.05	0.01	1 265
0.2	0.07	0.02	894
0.3	0.08	0.03	730
0.5	0.11	0.03	566
1.0	0.16	0.05	400
1.5	0.20	0.06	327
2.0	0.24	0.07	283
2.5	0.27	0.08	253
3.0	0.30	0.09	231
Attenuation calculation (dB/m)	[0.14 x √f GHz] + [0.02 x f GHz]		
Power calculation (W)	400 / √f GHz		

<sup>(1)</sup> OFC = Oxygen Free Copper

<sup>(2)</sup> PE = PolyEthylene

<sup>(3)</sup> Al = Aluminum

<sup>(4)</sup> TC = Tinned Copper

<sup>(5)</sup> LSZH PE = Low Smoke Zero Halogen PolyEthylene



Flexible cable 10/50 D (ECO393X)



ECO-Friendly cable  
Cost effective solution

P/N: C291 512 020

APPLICATION NOTE

Designed by Radiall, ECO393X is an alternative solution to ECO393 when higher power level is required:

• **Advantageous in term of electrical performance:** the crosslink foam polyethylene used as dielectric material allows higher temperature level (thus power range) than ECO393.

• **Environmental advantages:** halogen and sulphur free, this cable does not emit any toxic substance when submitted to fire. The flame retardant jacket allows ECO393X to meet fire resistance standards.

• **Advantageous in term of price:** ECO393X design has integrated all Radiall knowledge to reach the best performance with a very competitive price. ECO393X is UL style 3651 approved.

**This cable is compatible with a large range of standard connector series.**

CONSTRUCTION / DIMENSIONS

	Material	mm	Inches
Center conductor	Stranded SPC <sup>(1)</sup>	2.35	0.093
Dielectric	X foam PE <sup>(2)</sup>	7.20	0.283
Inner shield	SPC <sup>(1)</sup> braid	7.89	0.311
Outer shield	SPC <sup>(1)</sup> braid	8.57	0.337
Jacket	Black LSZH PE <sup>(3)</sup>	10.00	0.394

ELECTRICAL CHARACTERISTICS

Characteristic impedance	50Ω ± 2Ω	
Operating frequency range	DC - 6 GHz	
Shielding effectiveness	78 dB [DC - 3 GHz]	
Voltage withstanding	5 000 V rms	
Capacitance	94 pF / m	28.1 pF / ft
Velocity of propagation	71 % (4.7 ns / m)	

MECHANICAL CHARACTERISTICS

Recommended minimum bending radius	50 mm	1.97 inch
Weight	180 g / m	0.120 lbs / ft

ENVIRONMENTAL CHARACTERISTICS

Operating temperature range	-40 / +105 °C	-40 / +221 °F
Fire resistance	Yes [UL1581 VW1]	
Halogen free	Yes [IEC 754-2]	

FREQUENCY / ATTENUATION (typ.) /  
CW MAX POWER (sea level / 25 °C)

GHz	dB / m	dB / ft	Watts
0.5	0.18	0.05	693
1.0	0.29	0.09	490
1.5	0.38	0.12	400
2.0	0.47	0.14	346
2.5	0.56	0.17	310
3.0	0.64	0.19	283
3.5	0.72	0.22	262
4.0	0.80	0.24	245
5.0	0.96	0.29	219
6.0	1.11	0.34	200
Attenuation calculation (dB/m)	[0.17 x √f GHz] + [0.115 x f GHz]		
Power calculation (W)	490 / √f GHz		

<sup>(1)</sup> SPC = Silver Plated Copper

<sup>(2)</sup> X foam PE = Crosslink foam PolyEthylene

<sup>(3)</sup> LSZH PE = Low Smoke Zero Halogen PolyEthylene

Note:

Typical attenuation for a couple of connectors (dB) = 0.045 x √f (GHz)

Corrugated cable 1/4" (Cellflex 1/4" Spiral)



P/N: C291 993 170

(Cellflex HCF 1/4" - 50 AlCu)

APPLICATION NOTE

The outer conductor of this cable is made up of a corrugated tube (spiral winding).

This construction allows perfect shielding and bendability while enabling a large bending radius.

The foam dielectric provides excellent loss and low return loss levels.

This cable will be advised for feeder and jumper assemblies in cellular networks as well as applications requiring high performance level on long distances.

The anti-UV LSZH (Low Smoke Zero Halogen) material is also flame retardant and allows this cable to be used for indoor public areas as well as outdoor installations.

CONSTRUCTION / DIMENSIONS

	Material	mm	Inches
Center conductor	Solid AlCC <sup>(1)</sup>	1.90	0.075
Dielectric	Foam PE <sup>(2)</sup>	4.30	0.169
Corrugated inner shield	Spiral copper tube	6.50	0.256
Outer shield	-	-	-
Jacket	Black LSZH PE <sup>(3)</sup>	7.80	0.307

ELECTRICAL CHARACTERISTICS

Characteristic impedance	50Ω ± 1Ω	
Operating frequency range	DC - 20.4 GHz	
Shielding effectiveness	110 dB	
Voltage withstanding	3 100 V rms	
Peak power	5.5 kW	
Capacitance	82 pF / m	24.8 pF / ft
Velocity of propagation	82 % (4.1 ns / m)	

MECHANICAL CHARACTERISTICS

Recommended minimum bending radius	25.0 mm	0.984 inch
Weight	70 g / m	0.047 lb / ft

ENVIRONMENTAL CHARACTERISTICS

Operating temperature range	-40 / +85 °C	-40 / +185 °F
Fire resistance	Yes [UL 1581 VW1 / IEC 332-1]	
Halogen free	Yes [IEC 754-2]	

FREQUENCY / ATTENUATION (typ. / 25 °C) /  
CW MAX POWER (sea level / 40 °C)

GHz	dB / m	dB / ft	Watts
1.0	0.19	0.06	339
2.0	0.27	0.08	232
3.0	0.34	0.10	185
4.0	0.40	0.12	156
6.0	0.51	0.15	124
8.0	0.60	0.18	104
10.0	0.69	0.21	91
12.4	0.78	0.24	79
18.0	0.99	0.30	63
20.0	1.06	0.32	59
Attenuation calculation (dB/m)	[0.17 x √f GHz] + [0.015 x f GHz]		

<sup>(1)</sup> AlCC = Aluminum Covered Copper

<sup>(2)</sup> PE = PolyEthylene

<sup>(3)</sup> LSZH PE = Low Smoke Zero Halogen PolyEthylene

## Corrugated cable 3/8" (Cellflex 3/8" Spiral)



**P/N: C291 996 170 (Cellflex HCF 3/8" CuH-50 AlCu)**

### APPLICATION NOTE

The outer conductor of this cable is made up of a corrugated tube (spiral winding).

This construction allows perfect shielding and bendability while enabling large bending radius.

The foam dielectric provides excellent loss and low return loss levels.

This cable is suitable for feeder and jumper assemblies in cellular networks as well as applications requiring high performance level on long distances.

The anti-UV LSZH (Low Smoke Zero Halogen) material is also flame retardant and allows this cable to be used for indoor public areas as well as outdoor installations.

## CONSTRUCTION / DIMENSIONS

	Material	mm	Inches
Center conductor	Solid AlCC <sup>(1)</sup>	2.60	0.102
Dielectric	Foam PE <sup>(2)</sup>	6.30	0.248
Corrugated inner shield	Spiral copper tube	9.10	0.358
Outer shield	-	-	-
Jacket	Black LSZH PE <sup>(3)</sup>	10.20	0.402

## ELECTRICAL CHARACTERISTICS

Characteristic impedance	50Ω ± 1Ω	
Operating frequency range	DC - 13.4 GHz	
Shielding effectiveness	110 dB	
Voltage withstanding	4 500 V rms	
Peak power	11.9 kW	
Capacitance	82 pF / m	24.8 pF / ft
Velocity of propagation	82 % (4.1 ns / m)	

## MECHANICAL CHARACTERISTICS

Recommended minimum bending radius	25.0 mm	0.984 inch
Weight	120 g / m	0.080 lbs / ft

## ENVIRONMENTAL CHARACTERISTICS

Operating temperature range	-40 / +85 °C	-40 / +185 °F
Fire resistance	Yes (UL 1581 VW1 / IEC 332-1)	
Halogen free	Yes (IEC 754-2)	

## FREQUENCY / ATTENUATION (typ. / 25 °C) / CW MAX POWER (sea level / 40 °C)

GHz	dB / m	dB / ft	Watts
0.5	0.09	0.03	810
1.0	0.13	0.04	560
1.5	0.17	0.05	449
2.0	0.19	0.06	384
3.0	0.24	0.07	306
4.0	0.29	0.09	260
6.0	0.36	0.11	205
8.0	0.43	0.13	173
10.0	0.49	0.15	152
12.4	0.56	0.17	133
Attenuation calculation (dB/m)	[0.123 x √f GHz] + [0.01 x f GHz]		

<sup>(1)</sup> AlCC = Aluminum Covered Copper

<sup>(2)</sup> PE = PolyEthylene

<sup>(3)</sup> LSZH PE = Low Smoke Zero Halogen PolyEthylene

### Note:

Typical attenuation for a couple of connectors (dB) = 0.045 x √f (GHz)

## Corrugated cable 1/2" (Cellflex 1/2" Spiral)



**P/N: C291 994 170 (Cellflex HCF 1/2" CuH-50 AlCu)**

### APPLICATION NOTE

The outer conductor of this cable is made up of a corrugated tube (spiral winding).

This construction allows perfect shielding and bendability while enabling large bending radius.

The foam dielectric provides excellent loss and low return loss levels.

This cable will be advised for feeder and jumper assemblies in cellular networks as well as applications requiring high performance level on long distances.

The anti-UV LSZH (Low Smoke Zero Halogen) material is also flame retardant and allows this cable to be used for indoor public areas as well as outdoor installations.

## CONSTRUCTION / DIMENSIONS

	Material	mm	Inches
Center conductor	Solid AlCC <sup>(1)</sup>	3.60	0.142
Dielectric	Foam PE <sup>(2)</sup>	8.30	0.327
Corrugated inner shield	Spiral copper tube	12.30	0.484
Outer shield	-	-	-
Jacket	Black LSZH PE <sup>(3)</sup>	13.50	0.531

## ELECTRICAL CHARACTERISTICS

Characteristic impedance	50Ω ± 1Ω	
Operating frequency range	DC - 11.7 GHz	
Shielding effectiveness	110 dB	
Voltage withstanding	5 845 V rms	
Peak power	20.5 kW	
Capacitance	82 pF / m	24.8 pF / ft
Velocity of propagation	82 % (4.1 ns / m)	

## MECHANICAL CHARACTERISTICS

Recommended minimum bending radius	32.0 mm	1.260 inch
Weight	210 g / m	0.140 lbs / ft

## ENVIRONMENTAL CHARACTERISTICS

Operating temperature range	-40 / +85 °C	-40 / +185 °F
Fire resistance	Yes (UL 1581 VW1 / IEC 332-1)	
Halogen free	Yes (IEC 754-2)	

## FREQUENCY / ATTENUATION (typ. / 25 °C) / CW MAX POWER (sea level / 40 °C)

GHz	dB / m	dB / ft	Watts
0.5	0.08	0.02	1 120
1.0	0.11	0.03	770
1.5	0.14	0.04	616
2.0	0.16	0.05	525
2.5	0.18	0.06	461
3.0	0.20	0.06	417
4.0	0.24	0.07	353
6.0	0.30	0.09	278
8.0	0.36	0.11	234
10.0	0.42	0.13	204
Attenuation calculation (dB/m)	[0.10 x √f GHz] + [0.01 x f GHz]		

<sup>(1)</sup> AlCC = Aluminum Covered Copper

<sup>(2)</sup> PE = PolyEthylene

<sup>(3)</sup> LSZH PE = Low Smoke Zero Halogen PolyEthylene

**Semi-rigid cable .047 (Copper)**

**P/N: C291 855 001  
(MIL-C-17/151-00001)**

**APPLICATION NOTE**

This is the smallest semi-rigid cable size available through Radiall.

Its reduced size allows it to be easily handformable during integration operations.

**CONSTRUCTION / DIMENSIONS**

	Material	mm	Inches
Center conductor	Solid SPCCS <sup>(1)</sup>	0.29	0.011
Dielectric	Solid PTFE <sup>(2)</sup>	0.94	0.037
Inner shield	Copper tubing	1.19	0.047
Outer shield	-	-	-
Jacket	-	-	-

**ELECTRICAL CHARACTERISTICS**

Characteristic impedance	50Ω ± 2.5Ω	
Operating frequency range	DC - 20 GHz	
Shielding effectiveness	110 dB	
Voltage withstanding	2 000 V rms	
Peak power	1.1 kW	
Capacitance	100 pF / m	30 pF / ft
Velocity of propagation	70 % (4.8 ns / m)	

**MECHANICAL CHARACTERISTICS**

Recommended minimum bending radius	3.17 mm	0.125 inch
Weight	6.0 g / m	0.0040 lbs / ft

**ENVIRONMENTAL CHARACTERISTICS**

Operating temperature range	-40 / +100 °C	-40 / +212 °F
Fire resistance	N/A	
Halogen free	No	

**FREQUENCY / ATTENUATION (typ.) /  
CW MAX POWER (sea level / 25 °C)**

GHz	dB / m	dB / ft	Watts
1.0	1.14	0.35	30
2.0	1.64	0.50	21
3.0	2.03	0.61	17
6.0	2.93	0.89	12
8.0	3.43	1.04	11
10.0	3.88	1.18	9.5
12.4	4.37	1.32	8.5
18.0	5.39	1.63	7.1
20.0	5.72	1.73	6.7
Attenuation calculation (dB/m)	(1.10 x √f GHz) + (0.04 x f GHz)		
Power calculation (W)	30 / √f GHz		

<sup>(1)</sup> SPCCS = Silver Plated Copper Covered Steel

<sup>(2)</sup> PTFE = PolyTetraFluoroEthylene

**Semi-rigid cable .047 (Tinned copper)**

**P/N: C291 855 065 (MIL-C-17/151-00002 TYPE)**

**APPLICATION NOTE**

This is the smallest semi-rigid cable size available at Radiall.

Its reduced size allows it to be easily handformable during integration operations.

Due to the outer conductor coating (tin), this cable will be used instead of standard .047 copper for applications requiring high corrosion resistance and improved solderability.

**CONSTRUCTION / DIMENSIONS**

	Material	mm	Inches
Center conductor	Solid SPCCS <sup>(1)</sup>	0.29	0.011
Dielectric	Solid PTFE <sup>(2)</sup>	0.94	0.037
Inner shield	TC <sup>(3)</sup> tubing	1.19	0.047
Outer shield	-	-	-
Jacket	-	-	-

**ELECTRICAL CHARACTERISTICS**

Characteristic impedance	50Ω ± 2.5Ω	
Operating frequency range	DC - 20 GHz	
Shielding effectiveness	110 dB	
Voltage withstanding	2 000 V rms	
Peak power	1.1 kW	
Capacitance	100 pF / m	30 pF / ft
Velocity of propagation	70 % (4.8 ns / m)	

**MECHANICAL CHARACTERISTICS**

Recommended minimum bending radius	3.17 mm	0.125 inch
Weight	6.0 g / m	0.0040 lbs / ft

**ENVIRONMENTAL CHARACTERISTICS**

Operating temperature range	-40 / +100 °C	-40 / +212 °F
Fire resistance	N/A	
Halogen free	No	

**FREQUENCY / ATTENUATION (typ.) /  
CW MAX POWER (sea level / 25 °C)**

GHz	dB / m	dB / ft	Watts
1.0	1.14	0.35	30
2.0	1.64	0.50	21
3.0	2.03	0.61	17
6.0	2.93	0.89	12
8.0	3.43	1.04	11
10.0	3.88	1.18	9.5
12.4	4.37	1.32	8.5
18.0	5.39	1.63	7.1
20.0	5.72	1.73	6.7
Attenuation calculation (dB/m)	(1.10 x √f GHz) + (0.04 x f GHz)		
Power calculation (W)	30 / √f GHz		

<sup>(1)</sup> SPCCS = Silver Plated Copper Covered Steel

<sup>(2)</sup> PTFE = PolyTetraFluoroEthylene

<sup>(3)</sup> TC = Tinned Copper

**Note:**

Typical attenuation for a couple of connectors (dB) = 0.045 x √f (GHz)



## Hand-formable cable .085 (unjacketed)



**P/N: C291 844 065**

### APPLICATION NOTE

This handformable cable is the perfect alternative to RG405 for applications requiring an easy routing on equipment.

Due to the outer conductor construction, this cable can be hand formed with exceptional ease with no spring back effect.

Cable can be reshaped, eliminating the need for costly drawings.

Attenuation is a little bit higher than RG405 but temperature range is wider.

## CONSTRUCTION / DIMENSIONS

	Material	mm	Inches
Center conductor	Solid SPCCS <sup>(1)</sup>	0.51	0.020
Dielectric	Solid PTFE <sup>(2)</sup>	1.63	0.064
Inner shield	copper foil	-	-
Outer shield	TS <sup>(3)</sup> braid	2.21	0.087
Jacket	-	-	-

## ELECTRICAL CHARACTERISTICS

Characteristic impedance	50Ω ± 2Ω	
Operating frequency range	DC - 20 GHz	
Shielding effectiveness	90 dB	
Voltage withstanding	5 000 V rms	
Peak power	1.9 kW	
Capacitance	97.5 pF / m	29.5 pF / ft
Velocity of propagation	70 % (4.8 ns / m)	

## MECHANICAL CHARACTERISTICS

Recommended minimum bending radius	3.2 <sup>(4)</sup> / 9.5 <sup>(5)</sup> mm	0.125 <sup>(4)</sup> / 0.375 <sup>(5)</sup> inch
Weight	17.8 g / m	0.0119 lbs / ft

## ENVIRONMENTAL CHARACTERISTICS

Operating temperature range	-65 / +150 °C	-85 / +302 °F
Fire resistance	N/A	
Halogen free	No	

## FREQUENCY / ATTENUATION (typ.) / CW MAX POWER (sea level / 25 °C)

GHz	dB / m	dB / ft	Watts
1.0	0.67	0.20	100
2.0	0.97	0.29	71
3.0	1.21	0.37	58
6.0	1.78	0.54	41
8.0	2.10	0.64	35
10.0	2.39	0.72	32
12.4	2.71	0.82	28
18.0	3.39	1.03	24
20.0	3.62	1.10	22
Attenuation calculation (dB/m)	[0.63 x √f GHz] + [0.04 x f GHz]		
Power calculation (W)	100 / √f GHz		

<sup>(1)</sup> SPCCS = Silver Plated Copper Covered Steel

<sup>(2)</sup> PTFE = PolyTetraFluoroEthylene

<sup>(3)</sup> TS = Tin Soaked

<sup>(4)</sup> one time

<sup>(5)</sup> repeated

### Note:

Typical attenuation for a couple of connectors (dB) = 0.045 x √f (GHz)

## Semi-rigid cable .085 (RG405 - KS1)



**P/N: C291 850 001**  
**(MIL-C-17/133-RG405)**  
**(NF-C-93/551-KS1)**

### APPLICATION NOTE

RG405 is one of the most popular semi-rigid RG cables.

RG405 is a more preferred option to flexible RG316 or RD316 for applications requiring high frequency range, low attenuation, high screening effectiveness, very small bending radius and/or no spring back effect.

## CONSTRUCTION / DIMENSIONS

	Material	mm	Inches
Center conductor	Solid SPCCS <sup>(1)</sup>	0.51	0.020
Dielectric	Solid PTFE <sup>(2)</sup>	1.68	0.066
Inner shield	Copper tubing	2.20	0.087
Outer shield	-	-	-
Jacket	-	-	-

## ELECTRICAL CHARACTERISTICS

Characteristic impedance	50Ω ± 1.5Ω	
Operating frequency range	DC - 20 GHz	
Shielding effectiveness	110 dB	
Voltage withstanding	5 000 V rms	
Peak power	1.9 kW	
Capacitance	100 pF / m	30 pF / ft
Velocity of propagation	70 % (4.8 ns / m)	

## MECHANICAL CHARACTERISTICS

Recommended minimum bending radius	3.17 mm	0.125 inch
Weight	20.0 g / m	0.0135 lbs / ft

## ENVIRONMENTAL CHARACTERISTICS

Operating temperature range	-40 / +125 °C	-40 / +257 °F
Fire resistance	N/A	
Halogen free	No	

## FREQUENCY / ATTENUATION (typ.) / CW MAX POWER (sea level / 25 °C)

GHz	dB / m	dB / ft	Watts
1.0	0.65	0.20	100
2.0	0.94	0.29	71
3.0	1.18	0.36	58
6.0	1.73	0.53	41
8.0	2.05	0.62	35
10.0	2.33	0.71	32
12.4	2.64	0.80	28
18.0	3.31	1.00	24
20.0	3.53	1.07	22
Attenuation calculation (dB/m)	[0.61 x √f GHz] + [0.04 x f GHz]		
Power calculation (W)	100 / √f GHz		

<sup>(1)</sup> SPCCS = Silver Plated Copper Covered Steel

<sup>(2)</sup> PTFE = PolyTetraFluoroEthylene

**Semi-rigid cable .085 (Tinned copper)**

**P/N: C291 850 005  
(MIL-C-17/133-00007)**

**APPLICATION NOTE**

Due to the outer conductor coating (tin), this cable can be used instead of RG405 for applications requiring high corrosion resistance and improved solderability.

**CONSTRUCTION / DIMENSIONS**

	Material	mm	Inches
Center conductor	Solid SPCCS <sup>(1)</sup>	0.51	0.020
Dielectric	Solid PTFE <sup>(2)</sup>	1.68	0.066
Inner shield	TPC <sup>(3)</sup>	2.20	0.087
Outer shield	-	-	-
Jacket	-	-	-

**ELECTRICAL CHARACTERISTICS**

Characteristic impedance	50Ω ± 1.5Ω	
Operating frequency range	DC - 20 GHz	
Shielding effectiveness	110 dB	
Voltage withstanding	5 000 V DC	
Peak power	1.9 kW	
Capacitance	100 pF / m	30 pF / ft
Velocity of propagation	70 % (4.8 ns / m)	

**MECHANICAL CHARACTERISTICS**

Recommended minimum bending radius	3.17 mm	0.125 inch
Weight	20.0 g / m	0.0135 lbs / ft

**ENVIRONMENTAL CHARACTERISTICS**

Operating temperature range	-40 / +125 °C	-40 / +257 °F
Fire resistance	N/A	
Halogen free	No	

**FREQUENCY / ATTENUATION (typ.) /  
CW MAX POWER (sea level / 25 °C)**

GHz	dB / m	dB / ft	Watts
1.0	0.65	0.20	100
2.0	0.94	0.29	71
3.0	1.18	0.36	58
6.0	1.73	0.53	41
8.0	2.05	0.62	35
10.0	2.33	0.71	32
12.4	2.64	0.80	28
18.0	3.31	1.00	24
20.0	3.53	1.07	22
Attenuation calculation (dB/m)	[0.61 x √f GHz] + [0.04 x f GHz]		
Power calculation (W)	100 / √f GHz		

<sup>(1)</sup> SPCCS = Silver Plated Copper Covered Steel

<sup>(2)</sup> PTFE = PolyTetraFluoroEthylene

<sup>(3)</sup> TPC = Tin Plated Copper

**Semi-rigid cable .085 (Non magnetic)**

**P/N: C291 851 001  
(MIL-C-17/133-00008)**

**APPLICATION NOTE**

Based on RG405 standard, this cable is used where non magnetic is required.

**CONSTRUCTION / DIMENSIONS**

	Material	mm	Inches
Center conductor	Solid SPC <sup>(1)</sup>	0.51	0.020
Dielectric	Solid PTFE <sup>(2)</sup>	1.68	0.066
Inner shield	Copper tubing	2.20	0.087
Outer shield	-	-	-
Jacket	-	-	-

**ELECTRICAL CHARACTERISTICS**

Characteristic impedance	50Ω ± 1.5Ω	
Operating frequency range	DC - 20 GHz	
Shielding effectiveness	110 dB	
Voltage withstanding	5 000 V rms	
Peak power	1.9 kW	
Capacitance	100 pF / m	30 pF / ft
Velocity of propagation	70 % (4.8 ns / m)	

**MECHANICAL CHARACTERISTICS**

Recommended minimum bending radius	3.17 mm	0.125 inch
Weight	20.0 g / m	0.0135 lbs / ft

**ENVIRONMENTAL CHARACTERISTICS**

Operating temperature range	-40 / +125 °C	-40 / +257 °F
Fire resistance	N/A	
Halogen free	No	

**FREQUENCY / ATTENUATION (typ.) /  
CW MAX POWER (sea level / 25 °C)**

GHz	dB / m	dB / ft	Watts
1.0	0.65	0.20	100
2.0	0.94	0.29	71
3.0	1.18	0.36	58
6.0	1.73	0.53	41
8.0	2.05	0.62	35
10.0	2.33	0.71	32
12.4	2.64	0.80	28
18.0	3.31	1.00	24
20.0	3.53	1.07	22
Attenuation calculation (dB/m)	[0.61 x √f GHz] + [0.04 x f GHz]		
Power calculation (W)	100 / √f GHz		

<sup>(1)</sup> SPC = Silver Plated Copper

<sup>(2)</sup> PTFE = PolyTetraFluoroEthylene

**Note:**

Typical attenuation for a couple of connectors (dB) = 0.045 x √f (GHz)

## Semi-rigid cable .085 (Aluminum)



**P/N: C291 844 187  
(MIL-C-17/133-00013)**

**APPLICATION NOTE**

Based on RG405 standard, this cable will be selected for application requiring easy conformability and/or application requiring reduced weight.  
Due to the aluminum outer conductor, this cable can be hand formed with exceptional ease with no spring back effect.  
The cable can be reshaped, eliminating the need for costly drawings.  
The outer conductor material (aluminum) slightly increases the attenuation compared to standard RG405.

### CONSTRUCTION / DIMENSIONS

	Material	mm	Inches
Center conductor	Solid SPCCS <sup>(1)</sup>	0.51	0.020
Dielectric	Solid PTFE <sup>(2)</sup>	1.68	0.066
Inner shield	TPAI <sup>(3)</sup> tubing	2.20	0.087
Outer shield	-	-	-
Jacket	-	-	-

### ELECTRICAL CHARACTERISTICS

Characteristic impedance	50Ω ± 1Ω	
Operating frequency range	DC - 20 GHz	
Shielding effectiveness	110 dB	
Voltage withstanding	5 000 V rms	
Peak power	1.9 kW	
Capacitance	100 pF / m	30 pF / ft
Velocity of propagation	70 % (4.8 ns / m)	

### MECHANICAL CHARACTERISTICS

Recommended minimum bending radius	1.8 mm	0.07 inch
Weight	10.7 g / m	0.0072 lbs / ft

### ENVIRONMENTAL CHARACTERISTICS

Operating temperature range	-40 / +125 °C	-40 / +257 °F
Fire resistance	N/A	
Halogen free	No	

### FREQUENCY / ATTENUATION (typ.) / CW MAX POWER (sea level / 25 °C)

GHz	dB / m	dB / ft	Watts
1.0	0.68	0.20	100
2.0	0.98	0.30	71
3.0	1.22	0.37	58
6.0	1.80	0.54	41
8.0	2.12	0.64	35
10.0	2.41	0.73	32
12.4	2.73	0.83	28
18.0	3.41	1.03	24
20.0	3.64	1.10	22
Attenuation calculation (dB/m)	[0.635 x √f GHz] + [0.04 x f GHz]		
Power calculation (W)	100 / √f GHz		

<sup>(1)</sup> SPCCS = Silver Plated Copper Covered Steel  
<sup>(2)</sup> PTFE = PolyTetraFluoroEthylene  
<sup>(3)</sup> TPAI = Tin Plated Aluminum

**Note:**  
Typical attenuation for a couple of connectors (dB) = 0.045 x √f (GHz)

## Hand-formable cable .141 (Unjacketed)



**P/N: C291 864 065**

**APPLICATION NOTE**

This handformable cable is an alternative to RG402 for applications requiring an easy routing on equipment.  
Due to the outer conductor construction, this cable can be hand formed with exceptional ease with no spring back effect.  
The cable can be reshaped, eliminating the need for costly drawings.  
Attenuation is a little bit higher than RG402 but the temperature range is wider.

### CONSTRUCTION / DIMENSIONS

	Material	mm	Inches
Center conductor	Solid SPCCS <sup>(1)</sup>	0.92	0.036
Dielectric	Solid PTFE <sup>(2)</sup>	2.95	0.116
Inner shield	Copper tape	-	-
Outer shield	TS <sup>(3)</sup> braid	3.50	0.138
Jacket	-	-	-

### ELECTRICAL CHARACTERISTICS

Characteristic impedance	50Ω ± 2Ω	
Operating frequency range	DC - 20 GHz	
Shielding effectiveness	90 dB	
Voltage withstanding	5 000 V rms	
Peak power	3.4 kW	
Capacitance	97.5 pF / m	29.5 pF / ft
Velocity of propagation	70 % (4.8 ns / m)	

### MECHANICAL CHARACTERISTICS

Recommended minimum bending radius	6.4 <sup>(4)</sup> / 19 <sup>(5)</sup> mm	0.25 <sup>(4)</sup> / 0.75 <sup>(5)</sup> inch
Weight	33 g / m	0.0221 lbs / ft

### ENVIRONMENTAL CHARACTERISTICS

Operating temperature range	-65 / +150 °C	-85 / +302 °F
Fire resistance	N/A	
Halogen free	No	

### FREQUENCY / ATTENUATION (typ.) / CW MAX POWER (sea level / 25 °C)

GHz	dB / m	dB / ft	Watts
1.0	0.39	0.12	315
2.0	0.57	0.17	223
3.0	0.72	0.22	182
6.0	1.09	0.33	129
8.0	1.30	0.39	111
10.0	1.49	0.45	100
12.4	1.71	0.52	89
18.0	2.18	0.66	74
20.0	2.34	0.71	70
Attenuation calculation (dB/m)	[0.345 x √f GHz] + [0.04 x f GHz]		
Power calculation (W)	315 / √f GHz		

<sup>(1)</sup> SPCCS = Silver Plated Copper Covered Steel  
<sup>(2)</sup> PTFE = PolyTetraFluoroEthylene  
<sup>(3)</sup> TS = Tin Soaked  
<sup>(4)</sup> one time  
<sup>(5)</sup> repeated

Hand-formable cable .141 (Jacketed)



P/N: C291 866 378

APPLICATION NOTE

This jacketed cable will be used instead of standard unjacketed .141 for applications requiring electrical insulation and/or protection against environmental aggressions (chemical, humidity...).

The FEP jacket allows this cable to be used under severe thermal conditions.

The jacket slightly increases the spring back effect.

CONSTRUCTION / DIMENSIONS

	Material	mm	Inches
Center conductor	Solid SPC <sup>(1)</sup>	0.92	0.036
Dielectric	Solid PTFE <sup>(2)</sup>	2.98	0.117
Inner shield	TS <sup>(3)</sup> braid	3.50	0.138
Outer shield	-	-	-
Jacket	Black FEP <sup>(4)</sup>	4.05	0.159

ELECTRICAL CHARACTERISTICS

Characteristic impedance	50Ω ± 2Ω	
Operating frequency range	DC - 20 GHz	
Shielding effectiveness	90 dB	
Voltage withstanding	5 000 V rms	
Peak power	3.4 kW	
Capacitance	97.5 pF / m	29.5 pF / ft
Velocity of propagation	70 % (4.8 ns / m)	

MECHANICAL CHARACTERISTICS

Recommended minimum bending radius	11 <sup>(5)</sup> / 33 <sup>(6)</sup> mm	0.43 <sup>(5)</sup> / 1.3 <sup>(6)</sup> inch
Weight	38 g / m	0.0254 lbs / ft

ENVIRONMENTAL CHARACTERISTICS

Operating temperature range	-65 / +150 °C	-85 / +302 °F
Fire resistance	Yes (CSA FT6 / IEC 332-2)	
Halogen free	No	

FREQUENCY / ATTENUATION (typ.) / CW MAX POWER (sea level / 25 °C)

GHz	dB / m	dB / ft	Watts
1.0	0.43	0.13	315
2.0	0.63	0.19	223
3.0	0.80	0.24	182
6.0	1.20	0.36	129
8.0	1.42	0.43	111
10.0	1.63	0.49	100
12.4	1.87	0.57	89
18.0	2.37	0.72	74
20.0	2.54	0.77	70
Attenuation calculation (dB/m)	[0.390 x √f GHz] + [0.04 x f GHz]		
Power calculation (W)	315 / √f GHz		

<sup>(1)</sup> SPC = Silver Plated Copper  
<sup>(2)</sup> PTFE = PolyTetraFluoroEthylene  
<sup>(3)</sup> TS = Tin Soaked  
<sup>(4)</sup> FEP = Fluorinated Ethylene Propylene  
<sup>(5)</sup> one time  
<sup>(6)</sup> repeated

Note:  
 Typical attenuation for a couple of connectors (dB) = 0.045 x √f (GHz)

Semi-rigid cable .141 (RG402 - KS2)

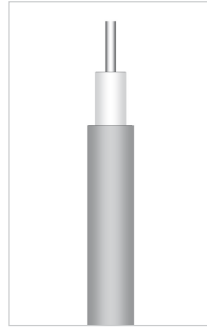

P/N: C291 860 001  
 (MIL-C-17/130-RG402)  
 (NF-C-93/551-KS2)

APPLICATION NOTE

RG402 is one of the most popular semi-rigid RG cables.

RG402 will be preferred to flexible RG142 for applications requiring high frequency range, low attenuation, high screening effectiveness, very small bending radius and/or no spring back effect.

CONSTRUCTION / DIMENSIONS

	Material	mm	Inches
Center conductor	Solid SPCCS <sup>(1)</sup>	0.92	0.036
Dielectric	Solid PTFE <sup>(2)</sup>	2.98	0.117
Inner shield	Copper tubing	3.58	0.141
Outer shield	-	-	-
Jacket	-	-	-

ELECTRICAL CHARACTERISTICS

Characteristic impedance	50Ω ± 1Ω	
Operating frequency range	DC - 20 GHz	
Shielding effectiveness	110 dB	
Voltage withstanding	5 000 V rms	
Peak power	3.4 kW	
Capacitance	89 pF / m	27 pF / ft
Velocity of propagation	70 % (4.8 ns / m)	

MECHANICAL CHARACTERISTICS

Recommended minimum bending radius	6.35 mm	0.250 inch
Weight	46 g / m	0.0309 lbs / ft

ENVIRONMENTAL CHARACTERISTICS

Operating temperature range	-40 / +125 °C	-40 / +257 °F
Fire resistance	N/A	
Halogen free	No	

FREQUENCY / ATTENUATION (typ.) / CW MAX POWER (sea level / 25 °C)

GHz	dB / m	dB / ft	Watts
1.0	0.34	0.10	315
2.0	0.50	0.15	223
3.0	0.64	0.19	182
6.0	0.97	0.30	129
8.0	1.17	0.35	111
10.0	1.35	0.41	100
12.4	1.55	0.47	89
18.0	1.99	0.60	74
20.0	2.14	0.65	70
Attenuation calculation (dB/m)	[0.30 x √f GHz] + [0.04 x f GHz]		
Power calculation (W)	315 / √f GHz		

<sup>(1)</sup> SPCCS = Silver Plated Copper Covered Steel  
<sup>(2)</sup> PTFE = PolyTetraFluoroEthylene

## Semi-rigid cable .141 (Tinned copper)



**P/N: C291 862 005  
(MIL-C-17/130-00005)**

### APPLICATION NOTE

Due to the outer conductor coating (tin), this cable will be used instead of RG402 for applications requiring high corrosion resistance and improved solderability. This cable is also an economical alternative to .141 silvered copper.

## CONSTRUCTION / DIMENSIONS

	Material	mm	Inches
Center conductor	Solid SPCCS <sup>(1)</sup>	0.92	0.036
Dielectric	Solid PTFE <sup>(2)</sup>	2.98	0.117
Inner shield	TPC <sup>(3)</sup>	3.58	0.141
Outer shield	-	-	-
Jacket	-	-	-

## ELECTRICAL CHARACTERISTICS

Characteristic impedance	50Ω ± 1Ω	
Operating frequency range	DC - 20 GHz	
Shielding effectiveness	110 dB	
Voltage withstanding	5 000 V rms	
Peak power	3.4 kW	
Capacitance	89 pF / m	27 pF / ft
Velocity of propagation	70 % (4.8 ns / m)	

## MECHANICAL CHARACTERISTICS

Recommended minimum bending radius	1.90 mm	0.075 inch
Weight	46 g / m	0.0309 lbs / ft

## ENVIRONMENTAL CHARACTERISTICS

Operating temperature range	-40 / +125 °C	-40 / +257 °F
Fire resistance	N/A	
Halogen free	No	

## FREQUENCY / ATTENUATION (typ.) / CW MAX POWER (sea level / 25 °C)

GHz	dB / m	dB / ft	Watts
1.0	0.34	0.10	315
2.0	0.50	0.15	223
3.0	0.64	0.19	182
6.0	0.97	0.30	129
8.0	1.17	0.35	111
10.0	1.35	0.41	100
12.4	1.55	0.47	89
18.0	1.99	0.60	74
20.0	2.14	0.65	70
Attenuation calculation (dB/m)	[0.30 x √f GHz] + [0.04 x f GHz]		
Power calculation (W)	315 / √f GHz		

<sup>(1)</sup> SPCCS = Silver Plated Copper Covered Steel

<sup>(2)</sup> PTFE = PolyTetraFluoroEthylene

<sup>(3)</sup> TPC = Tin Plated Copper

## Semi-rigid cable .141 (Silvered copper)



**P/N: C291 861 066**

### APPLICATION NOTE

Based on RG402 standard, this cable is used where non magnetic is required.

In addition, due to the outer conductor coating (silver), this cable will be used instead of RG402 for applications requiring high corrosion resistance and improved solderability.

## CONSTRUCTION / DIMENSIONS

	Material	mm	Inches
Center conductor	Solid SPC <sup>(1)</sup>	0.92	0.036
Dielectric	Solid PTFE <sup>(2)</sup>	2.98	0.117
Inner shield	SPC <sup>(1)</sup> tubing	3.58	0.141
Outer shield	-	-	-
Jacket	-	-	-

## ELECTRICAL CHARACTERISTICS

Characteristic impedance	50Ω ± 1Ω	
Operating frequency range	DC - 20 GHz	
Shielding effectiveness	110 dB	
Voltage withstanding	5 000 V rms	
Peak power	3.4 kW	
Capacitance	89 pF / m	27 pF / ft
Velocity of propagation	70 % (4.8 ns / m)	

## MECHANICAL CHARACTERISTICS

Recommended minimum bending radius	1.90 mm	0.075 inch
Weight	46 g / m	0.0309 lbs / ft

## ENVIRONMENTAL CHARACTERISTICS

Operating temperature range	-40 / +125 °C	-40 / +257 °F
Fire resistance	N/A	
Halogen free	No	

## FREQUENCY / ATTENUATION (typ.) / CW MAX POWER (sea level / 25 °C)

GHz	dB / m	dB / ft	Watts
1.0	0.34	0.10	315
2.0	0.50	0.15	223
3.0	0.64	0.19	182
6.0	0.97	0.30	129
8.0	1.17	0.35	111
10.0	1.35	0.41	100
12.4	1.55	0.47	89
18.0	1.99	0.60	74
20.0	2.14	0.65	70
Attenuation calculation (dB/m)	[0.30 x √f GHz] + [0.04 x f GHz]		
Power calculation (W)	315 / √f GHz		

<sup>(1)</sup> SPC = Silver Plated Copper

<sup>(2)</sup> PTFE = PolyTetraFluoroEthylene

### Note:

Typical attenuation for a couple of connectors (dB) = 0.045 x √f (GHz)

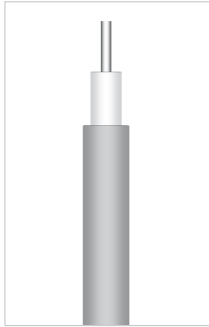
**Semi-rigid cable .141 (Non magnetic)****P/N: C291 861 061****APPLICATION NOTE**

Based on RG402 standard, this cable is used where non magnetic is required.

**CONSTRUCTION / DIMENSIONS**

	Material	mm	Inches
Center conductor	Solid SPC <sup>(1)</sup>	0.92	0.036
Dielectric	Solid PTFE <sup>(2)</sup>	2.98	0.117
Inner shield	Copper tubing	3.58	0.141
Outer shield	-	-	-
Jacket	-	-	-

**ELECTRICAL CHARACTERISTICS**

Characteristic impedance	50Ω ± 1Ω	
Operating frequency range	DC - 20 GHz	
Shielding effectiveness	110 dB	
Voltage withstanding	5 000 V rms	
Peak power	3.4 kW	
Capacitance	89 pF / m	27 pF / ft
Velocity of propagation	70 % (4.8 ns / m)	

**MECHANICAL CHARACTERISTICS**

Recommended minimum bending radius	2.54 mm	0.100 inch
Weight	46 g / m	0.0309 lbs / ft

**ENVIRONMENTAL CHARACTERISTICS**

Operating temperature range	-40 / +125 °C	-40 / +257 °F
Fire resistance	N/A	
Halogen free	No	

**FREQUENCY / ATTENUATION (typ.) /  
CW MAX POWER (sea level / 25 °C)**

GHz	dB / m	dB / ft	Watts
1.0	0.34	0.10	315
2.0	0.50	0.15	223
3.0	0.64	0.19	182
6.0	0.97	0.30	129
8.0	1.17	0.35	111
10.0	1.35	0.41	100
12.4	1.55	0.47	89
18.0	1.99	0.60	74
20.0	2.14	0.65	70
Attenuation calculation (dB/m)	[0.30 x √f GHz] + [0.04 x f GHz]		
Power calculation (W)	315 / √f GHz		

<sup>(1)</sup> SPC = Silver Plated Copper<sup>(2)</sup> PTFE = PolyTetraFluoroEthylene**Semi-rigid cable .141 (Aluminum)****P/N: C291 864 187****(MIL-C-17/130-00009)****APPLICATION NOTE**

Based on RG402 standard, this cable will be selected for application requiring easy conformability and/or application requiring reduced weight.

Due to the aluminum outer conductor, this cable can be hand formed with exceptional ease with no spring back effect.

Cable can be reshaped, eliminating the need for costly drawings. The outer conductor material (aluminum) slightly increases the attenuation compared to standard RG402.

**CONSTRUCTION / DIMENSIONS**

	Material	mm	Inches
Center conductor	Solid SPCCS <sup>(1)</sup>	0.92	0.036
Dielectric	Solid PTFE <sup>(2)</sup>	2.98	0.117
Inner shield	TPA <sup>(3)</sup>	3.58	0.141
Outer shield	-	-	-
Jacket	-	-	-

**ELECTRICAL CHARACTERISTICS**

Characteristic impedance	50Ω ± 1Ω	
Operating frequency range	DC - 20 GHz	
Shielding effectiveness	110 dB	
Voltage withstanding	5 000 V rms	
Peak power	3.4 kW	
Capacitance	89 pF / m	27 pF / ft
Velocity of propagation	70 % (4.8 ns / m)	

**MECHANICAL CHARACTERISTICS**

Recommended minimum bending radius	3.17 mm	0.125 inch
Weight	30 g / m	0.0185 lbs / ft

**ENVIRONMENTAL CHARACTERISTICS**

Operating temperature range	-40 / +125 °C	-40 / +257 °F
Fire resistance	N/A	
Halogen free	No	

**FREQUENCY / ATTENUATION (typ.) /  
CW MAX POWER (sea level / 25 °C)**

GHz	dB / m	dB / ft	Watts
1.0	0.36	0.11	315
2.0	0.53	0.16	223
3.0	0.67	0.20	182
6.0	1.02	0.31	129
8.0	1.23	0.37	111
10.0	1.41	0.43	100
12.4	1.62	0.49	89
18.0	2.08	0.63	74
20.0	2.23	0.68	70
Attenuation calculation (dB/m)	[0.32 x √f GHz] + [0.04 x f GHz]		
Power calculation (W)	315 / √f GHz		

<sup>(1)</sup> SPCCS = Silver Plated Copper Covered Steel<sup>(2)</sup> PTFE = PolyTetraFluoroEthylene<sup>(3)</sup> TPA = Tin Plated Aluminum**Note:**

Typical attenuation for a couple of connectors (dB) = 0.045 x √f (GHz)

## Semi-rigid cable .250 (RG401 - KS3)



**P/N: C291 870 001**  
**(MIL-C-17/129-RG401)**  
**(NF-C-93/551-KS3)**

### APPLICATION NOTE

RG401 will be used for application requiring very low attenuation, high power and high screening effectiveness.

Note: reduced operating temperature range.

## CONSTRUCTION / DIMENSIONS

	Material	mm	Inches
Center conductor	Solid SPC <sup>(1)</sup>	1.63	0.064
Dielectric	Solid PTFE <sup>(2)</sup>	5.31	0.209
Inner shield	Copper tubing	6.35	0.250
Outer shield	-	-	-
Jacket	-	-	-

## ELECTRICAL CHARACTERISTICS

Characteristic impedance	50Ω ± 0.5Ω	
Operating frequency range	DC - 18 GHz	
Shielding effectiveness	110 dB	
Voltage withstanding	7 500 V rms	
Peak power	6.1 kW	
Capacitance	89 pF / m	27 pF / ft
Velocity of propagation	70 % (4.8 ns / m)	

## MECHANICAL CHARACTERISTICS

Recommended minimum bending radius	9.53 mm	0.375 inch
Weight	140 g / m	0.0945 lbs / ft

## ENVIRONMENTAL CHARACTERISTICS

Operating temperature range	-40 / +90 °C	-40 / +194 °F
Fire resistance	N/A	
Halogen free	No	

## FREQUENCY / ATTENUATION (typ.) / CW MAX POWER (sea level / 25 °C)

GHz	dB / m	dB / ft	Watts
1.0	0.21	0.06	900
2.0	0.31	0.09	636
3.0	0.41	0.12	520
6.0	0.64	0.20	367
8.0	0.79	0.24	318
10.0	0.92	0.28	285
12.4	1.08	0.33	256
18.0	1.42	0.43	212
20.0	1.54	0.47	201
Attenuation calculation (dB/m)	[0.165 x √f GHz] + [0.04 x f GHz]		
Power calculation (W)	900 / √f GHz		

<sup>(1)</sup> SPC = Silver Plated Copper

<sup>(2)</sup> PTFE = PolyTetraFluoroEthylene

## Semi-rigid cable .250 (Aluminum)



**P/N: C291 874 187**

### APPLICATION NOTE

Based on RG401 standard, this cable will be selected for application requiring easy conformability and/or application requiring reduced weight.

Due to the aluminum outer conductor, this cable can be hand formed with exceptional ease with no spring back effect.

Cable can be reshaped, eliminating the need for costly drawings.

The outer conductor material (aluminum) slightly increases the attenuation compared to standard RG401.

## CONSTRUCTION / DIMENSIONS

	Material	mm	Inches
Center conductor	Solid SPC <sup>(1)</sup>	1.63	0.064
Dielectric	Solid PTFE <sup>(2)</sup>	5.31	0.209
Inner shield	TPAL <sup>(3)</sup> tubing	6.35	0.250
Outer shield	-	-	-
Jacket	-	-	-

## ELECTRICAL CHARACTERISTICS

Characteristic impedance	50Ω ± 1Ω	
Operating frequency range	DC - 18 GHz	
Shielding effectiveness	110 dB	
Voltage withstanding	7 500 V rms	
Peak power	6.1 kW	
Capacitance	89 pF / m	27 pF / ft
Velocity of propagation	70 % (4.8 ns / m)	

## MECHANICAL CHARACTERISTICS

Recommended minimum bending radius	9.53 mm	0.375 inch
Weight	79.5 g / m	0.0530 lbs / ft

## ENVIRONMENTAL CHARACTERISTICS

Operating temperature range	-40 / +100 °C	-40 / +212 °F
Fire resistance	N/A	
Halogen free	No	

## FREQUENCY / ATTENUATION (typ.) / CW MAX POWER (sea level / 25 °C)

GHz	dB / m	dB / ft	Watts
1.0	0.22	0.07	550
2.0	0.33	0.10	389
3.0	0.43	0.13	318
6.0	0.68	0.21	225
8.0	0.83	0.25	194
10.0	0.97	0.29	174
12.4	1.13	0.34	156
18.0	1.48	0.45	130
20.0	1.60	0.49	123
Attenuation calculation (dB/m)	[0.18 x √f GHz] + [0.04 x f GHz]		
Power calculation (W)	550 / √f GHz		

<sup>(1)</sup> SPC = Silver Plated Copper

<sup>(2)</sup> PTFE = PolyTetraFluoroEthylene

<sup>(3)</sup> TPAL = Tin Plated Aluminum

### Note:

Typical attenuation for a couple of connectors (dB) = 0.045 x √f (GHz)



Low loss flexible cable 2.6/50 S+F  
(AEP-100FR alternative to LMR-100FR®)



**P/N: C291 327 060**

**APPLICATION NOTE**

AEP-100FR cable is an alternative solution to 50 Ohms LMR-100FR® cable offering the same performance and similar construction with cost advantage.

## REGULATIONS

RoHS compliant  
UL/NEC: CMR  
UL/CSA: FT4

## CONNECTORS COMPATIBLE WITH AEP-100FR (and to LMR® 100FR)

### QMA Series

P/N	Interface	Model
R123 071 000	Straight plug	Crimp type

### SMA Series

P/N	Interface	Model
R124 071 123	Straight plug	Crimp type
R124 172 123	R/A plug	Crimp type
R124 312 123	Straight BH jack	Crimp type

### TNC Series

P/N	Interface	Model
R143 075 000	Straight plug	Crimp type

### N Series

P/N	Interface	Model
R161 072 000	Straight plug	Crimp type

<sup>(1)</sup> BC = Bare Copper

<sup>(2)</sup> PE = PolyEthylene

## CONSTRUCTION / DIMENSIONS

	Material	mm	Inches
Center conductor	Solid BC <sup>(1)</sup>	0.46	0.018
Dielectric	Solid PE <sup>(2)</sup>	1.52	0.06
Inner shield	Al Tape Unbonded	1.65	0.065
Outer shield	Tinned Copper braid	2.11	0.083
Outer jacket	Black LSZH	2.79	0.11

## ELECTRICAL CHARACTERISTICS

Characteristic impedance	50 ohms	
Operating frequency range	DC - 6 GHz	
Dielectric constant	2.3	
Screening effectiveness	> 90 dB	
Velocity of propagation	66 %	
Capacitance	101.1 pF / m	30.8 pF / ft
Inductance	0.25 uH / m	0.077 uH / ft
Time delay	5.05 nS / m	1.54 nS / ft
Inner conductor DC resistance	266 ohms / km	81.0 ohms / 1000 ft
Outer conductor DC resistance	31.2 ohms / km	9.5 ohms / 1000 ft
Voltage withstand	500 Volts DC	
Jacket spark	2000 Volts RMS	
Peak power	0.6kW	
Phase stability over temp	< 25 ppm / deg C	

## MECHANICAL CHARACTERISTICS

Maximum weight	14 g / m	0.092 lb / ft
Min. bend radius: installation	6.4 mm	0.25 inch
Min. bend radius: repeated	25.4 mm	1.0 inch
Bending moment	0.014 N-m	0.1 ft-lb
Tensile strength	6.8 kg	15 lb
Flat plate crush	0.18 kg / mm	10 lb / inch

## ENVIRONMENTAL CHARACTERISTICS

Installation temperature range	-40 / +85 °C	-40 / +185 °F
Storage temperature range	-70 / +85 °C	-94 / +185 °F
Operating temperature range	-40 / +85 °C	-40 / +185 °F

## FREQUENCY / ATTENUATION (typ.) / AVG POWER <sup>(\*)</sup>

MHz	DB / 100 m	DB / 100 ft	kW
30	12.9	3.9	0.230
50	16.7	5.1	0.180
150	29.4	8.9	0.100
220	35.8	10.9	0.083
450	51.9	15.8	0.057
900	74.9	22.8	0.039
1500	98.7	30.1	0.029
1800	109.0	33.2	0.027
2000	115.5	35.2	0.025
2500	130.6	39.8	0.022
5800	210.3	64.1	0.013

<sup>(\*)</sup> = Avg power calculated at sea level / 40°C and VSWR 1:0

(Cable-assembly power ratings may be limited by the connector type. Please contact us for specific needs)



**Flexible low loss cable 5/50 S+F  
(AEP-195FR alternative to LMR-195FR®)**



**P/N: C291 327 010**

**APPLICATION NOTE**

AEP-195FR cable is an alternative solution to 50 Ohms LMR-195FR® cable offering the same performance and similar construction with cost advantage.

**REGULATIONS**

RoHS compliant  
UL/NEC:CMR  
UL/CSA: FT4

**CONNECTORS COMPATIBLE  
WITH AEP-195FR  
(and to LMR® 195FR)**

**QMA Series**

P/N	Interface	Model
R123 075 200	Straight plug	Crimp type

**SMA Series**

P/N	Interface	Model
R124 075 210	Straight plug	Crimp type
R124 175 110	R/A plug	Crimp type

**TNC Series**

P/N	Interface	Model
R143 082 027	Straight plug	Crimp type

**N Series**

P/N	Interface	Model
R161 082 120	Straight plug	Crimp type

<sup>(1)</sup> BC = Bare Copper

<sup>(2)</sup> PE = PolyEthylene

**CONSTRUCTION / DIMENSIONS**

	Material	mm	Inches
Center conductor	Solid BC <sup>(1)</sup>	0.94	0.037
Dielectric	Foam PE <sup>(2)</sup>	2.79	0.11
Inner shield	Aluminum Tape	2.95	0.116
Outer shield	Tinned Copper braid	3.53	0.139
Outer jacket	Black LSZH	4.95	0.195

**ELECTRICAL CHARACTERISTICS**

Characteristic impedance	50 ohms	
Operating frequency range	DC - 6 GHz	
Dielectric constant	1.56	
Screening effectiveness	> 90 dB	
Velocity of propagation	76 %	
Capacitance	83.3 pF / m	25.4 pF / ft
Inductance	0.21 uH / m	0.064 uH / ft
Time delay	4.17 nS / m	1.27 nS / ft
Inner conductor DC resistance	24.9 ohms / km	7.6 ohms / 1000 ft
Outer conductor DC resistance	16.1 ohms / km	4.9 ohms / 1000 ft
Voltage withstand	1000 Volts DC	
Jacket spark	3000 Volts RMS	
Peak power	2.5kW	
Phase stability over temp	< 25 ppm / deg C	

**MECHANICAL CHARACTERISTICS**

Maximum weight	30 g / m	0.021 lb / ft
Min. bend radius: installation	12.7 mm	0.5 inch
Min. bend radius: repeated	50.8 mm	2.0 inch
Bending moment	0.27 N-m	0.2 ft-lb
Tensile strength	18.2 kg	40 lb
Flat plate crush	0.27 kg / mm	15 lb / inch

**ENVIRONMENTAL CHARACTERISTICS**

Installation temperature range	-40 / +85 °C	-40 / +185 °F
Storage temperature range	-70 / +85 °C	-94 / +185 °F
Operating temperature range	-40 / +85 °C	-40 / +185 °F

**FREQUENCY / ATTENUATION (typ.) /  
AVG POWER <sup>(\*)</sup>**

MHz	DB / 100 m	DB / 100 ft	kW
30	6.5	2.0	0.89
50	8.4	2.5	0.68
150	14.6	4.4	0.39
220	17.7	5.4	0.32
450	25.5	7.8	0.22
900	36.5	11.1	0.16
1500	47.7	14.5	0.12
1800	52.5	16.0	0.11
2000	55.4	16.9	0.10
2500	62.4	19.0	0.09
5800	98.1	29.9	0.06

<sup>(\*)</sup> = Avg power calculated at sea level / 40°C and VSWR 1:0

(Cable-assembly power ratings may be limited by the connector type. Please contact us for specific needs)

### Low loss Flexible cable 5/50 S+F (AEP-200FR alternative to LMR-200FR®)



**P/N: C291 327 020**

#### APPLICATION NOTE

AEP-200FR cable is an alternative solution to 50 Ohms LMR-200FR® cable offering the same performance and similar construction with cost advantage.

### REGULATIONS

RoHS compliant  
UL/NEC: CMR  
UL/CSA: FT4

### CONNECTORS COMPATIBLE WITH AEP-200FR (and to LMR® 200FR)

#### QMA Series

P/N	Interface	Model
R123 096 110	Straight plug	Crimp type

#### SMA Series

P/N	Interface	Model
R124 076 450	Straight plug	Crimp type
R124 175 200	R/A plug	Crimp type

#### TNC Series

P/N	Interface	Model
R143 082 200	Straight plug	Crimp type

#### N Series

P/N	Interface	Model
R161 082 200	Straight plug	Crimp type
R161 182 080	R/A plug	Crimp type
R161 329 130	Straight BH jack	Crimp type

### CONSTRUCTION / DIMENSIONS

	Material	mm	Inches
Center conductor	Solid BC <sup>(1)</sup>	1.12	0.044
Dielectric	Foam PE <sup>(2)</sup>	2.95	0.116
Inner shield	Aluminum Tape	3.07	0.121
Outer shield	Tinned Copper braid	3.66	0.144
Outer jacket	Black LSZH	4.95	0.195

### ELECTRICAL CHARACTERISTICS

Characteristic impedance	50 ohms	
Operating frequency range	DC - 6 GHz	
Dielectric constant	1.45	
Screening effectiveness	> 90 dB	
Velocity of propagation	83 %	
Capacitance	80.3 pF / m	24.5 pF / ft
Inductance	0.20 uH / m	0.061 uH / ft
Time delay	4.02 nS / m	1.22 nS / ft
Inner conductor DC resistance	17.6 ohms / km	5.36 ohms / 1000 ft
Outer conductor DC resistance	16.1 ohms / km	4.9 ohms / 1000 ft
Voltage withstand	1000 Volts DC	
Jacket spark	3000 Volts RMS	
Peak power	2.5kW	
Phase stability over temp	< 25 ppm / deg C	

### MECHANICAL CHARACTERISTICS

Maximum weight	30 g / m	0.022 lb / ft
Min. bend radius: installation	12.7 mm	0.5 inch
Min. bend radius: repeated	50.8 mm	2.0 inch
Bending moment	0.27 N-m	0.2 ft-lb
Tensile strength	18.2 kg	40 lb
Flat plate crush	0.27 kg / mm	15 lb / inch

### ENVIRONMENTAL CHARACTERISTICS

Installation temperature range	-40 / +85 °C	-40 / +185 °F
Storage temperature range	-70 / +85 °C	-94 / +185 °F
Operating temperature range	-40 / +85 °C	-40 / +185 °F

### FREQUENCY / ATTENUATION (typ.) / AVG POWER<sup>(\*)</sup>

MHz	DB / 100 m	DB / 100 ft	kW
30	5.8	1.8	1.02
50	7.5	2.3	0.79
150	13.1	4.0	0.45
220	15.9	4.8	0.37
450	22.8	7.0	0.26
900	32.6	9.9	0.18
1500	42.4	12.9	0.14
1800	46.6	14.2	0.13
2000	49.3	15.0	0.12
2500	55.4	16.9	0.11
5800	86.5	26.4	0.07

<sup>(\*)</sup> = Avg power calculated at sea level / 40°C and VSWR 1:0  
(Cable-assembly power ratings may be limited by the connector type.  
Please contact us for specific needs)

## Flexible low loss cable 6.1/50 S+F (AEP-240FR alternative to LMR-240FR®)



**P/N: C291 327 030**

### APPLICATION NOTE

AEP-240FR cable is an alternative solution to 50 Ohms LMR-240FR® cable offering the same performance and similar construction with cost advantage.

### REGULATIONS

RoHS compliant  
UL/NEC: CMR  
UL/CSA: FT4

### CONNECTORS COMPATIBLE WITH AEP-240FR (and to LMR® 240FR)

#### QMA Series

P/N	Interface	Model
R123 076 310	Straight plug	Crimp type
R123 177 100	R/a plug	Crimp type
R123 314 010	Straight bh jack	Crimp type
R123W 076 310	Wp straight plug	Crimp type
R123W 177 110	Wp r/a plug	Crimp type

#### SMA Series

P/N	Interface	Model
R124 076 430	Straight plug	Crimp type
R124 175 310	R/A plug	Crimp type

#### TNC Series

P/N	Interface	Model
R143 084 161	Straight plug	Crimp type

#### N Series

P/N	Interface	Model
R161 075 030	Straight plug	Crimp type
R161 183 310	R/A plug	Crimp type
R161 329 140	Straight bh jack	Crimp type

#### QN Series

P/N	Interface	Model
R164 075 010	Straight plug	Crimp type

#### 7/16 Series

P/N	Interface	Model
R185 085 007	Straight plug	Crimp type
R185 320 020	Straight BH jack	Crimp type

<sup>(1)</sup> BC = Bare Copper

<sup>(2)</sup> PE = PolyEt hylene

### CONSTRUCTION / DIMENSIONS

	Material	mm	Inches
Center conductor	Solid BC <sup>(1)</sup>	1.42	0.056
Dielectric	Foam PE <sup>(2)</sup>	3.81	0.15
Inner shield	Aluminum Tape	3.94	0.155
Outer shield	Tinned Copper braid	4.52	0.178
Outer jacket	Black LSZH	6.1	0.24

### ELECTRICAL CHARACTERISTICS

Characteristic impedance	50 ohms	
Operating frequency range	DC - 6 GHz	
Dielectric constant	1.42	
Screening effectiveness	> 90 dB	
Velocity of propagation	84 %	
Capacitance	79.4 pF / m	24.2 pF / ft
Inductance	0.20 uH / m	0.060 uH / ft
Time delay	3.97 nS / m	1.21 nS / ft
Inner conductor dc resistance	10.5 ohms / km	3.2 ohms / 1000 ft
Outer conductor dc resistance	12.8 ohms / km	3.89 ohms / 1000 ft
Voltage withstand	1500 Volts DC	
Jacket spark	5000 Volts RMS	
Peak power	5.6kW	
Phase stability over temp	< 25 ppm / deg C	

### MECHANICAL CHARACTERISTICS

Maximum weight	0.05 kg / m	0.034 lb / ft
Min. bend radius: installation	19.1 mm	0.75 inch
Min. bend radius: repeated	63.5 mm	2.5 inch
Bending moment	0.34 N-m	0.25 ft-lb
Tensile strength	36.3 kg	80 lb
Flat plate crush	0.36 kg / mm	20 lb / inch

### ENVIRONMENTAL CHARACTERISTICS

Installation temperature range	-40 / +85 °C	-40 / +185 °F
Storage temperature range	-70 / +85 °C	-94 / +185 °F
Operating temperature range	-40 / +85 °C	-40 / +185 °F

### FREQUENCY / ATTENUATION (typ.) / AVG POWER <sup>(\*)</sup>

MHz	DB / 100 m	DB / 100 ft	kW
30	4.4	1.3	1.49
50	5.7	1.7	1.15
150	9.9	3.0	0.66
220	12.0	3.7	0.54
450	17.3	5.3	0.38
900	24.8	7.6	0.26
1500	32.4	9.9	0.20
1800	35.6	10.9	0.18
2000	37.7	11.5	0.17
2500	42.4	12.9	0.15
5800	66.8	20.4	0.10

<sup>(\*)</sup> = Avg power calculated at sea level / 40°C and VSWR 1:0

[Cable-assembly power ratings may be limited by the connector type. Please contact us for specific needs]

### Low loss Flexible cable 10.3/50 S+F (AEP-400FR alternative to LMR-400FR®)



**P/N: C291 .327 040**

#### APPLICATION NOTE

AEP-400FR cable is an alternative solution to 50 Ohms LMR-400FR® cable offering the same performance and similar construction with cost advantage.

## REGULATIONS

RoHS compliant  
UL/NEC: CMR  
UL/CSA: FT4

## CONNECTORS COMPATIBLE WITH AEP-400FR (and to LMR® 400FR)

### SMA Series

P/N	Interface	Model
R124 080 030	Straight plug	Crimp type

### TNC Series

P/N	Interface	Model
R143 089 117	Straight plug	Crimp type

### N Series

P/N	Interface	Model
R161 088 180	Straight plug	Crimp type
R161 184 080	R/A plug	Crimp type
R161 331 060	Straight bh jack	Crimp type

### QN Series

P/N	Interface	Model
R164 080 020	Straight plug	Crimp type
R164 185 007	R/A plug	Crimp type
R164 241 020	Straight bh jack	Crimp type

### 7/16 Series

P/N	Interface	Model
R185 085 007	Straight plug	Crimp type
R185 320 020	Straight BH jack	Crimp type

<sup>(1)</sup> BC = Bare Copper

<sup>(2)</sup> PE = PolyEt hylene

## CONSTRUCTION / DIMENSIONS

	Material	mm	Inches
Center conductor	Solid BCCAL <sup>(1)</sup>	2.74	0.108
Dielectric	Foam PE <sup>(2)</sup>	7.24	0.285
Inner shield	Aluminum Tape	7.39	0.291
Outer shield	Tinned Copper braid	8.13	0.32
Outer jacket	Black LSZH	10.29	0.405

## ELECTRICAL CHARACTERISTICS

Characteristic impedance	50 ohms	
Cut-off frequency	16 GHz	
Dielectric constant	1.38	
Screening effectiveness	> 90 dB	
Velocity of propagation	85 %	
Capacitance	78.4 pF / m	23.9 pF / ft
Inductance	0.20 uH / m	0.060 uH / ft
Time delay	3.97 nS / m	1.21 nS / ft
Inner conductor DC resistance	4.6 ohms / km	1.39 ohms / 1000 ft
Outer conductor DC resistance	5.4 ohms / km	1.65 ohms / 1000 ft
Voltage withstand	2500 Volts DC	
Jacket spark	8000 Volts RMS	
Peak power	16kW	
Phase stability over temp	< 25 ppm / deg C	

## MECHANICAL CHARACTERISTICS

Maximum weight	0.10 kg / m	0.068 lb / ft
Min. bend radius: installation	25.4 mm	1.00 inch
Min. bend radius: repeated	101.6 mm	4.0 inch
Bending moment	0.68 N-m	0.5 ft-lb
Tensile strength	72.6 kg	160 lb
Flat plate crush	0.71 kg / mm	40 lb / inch

## ENVIRONMENTAL CHARACTERISTICS

Installation temperature range	-40 / +85 °C	-40 / +185 °F
Storage temperature range	-70 / +85 °C	-94 / +185 °F
Operating temperature range	-40 / +85 °C	-40 / +185 °F

## FREQUENCY / ATTENUATION (typ.) / AVG POWER <sup>(\*)</sup>

MHz	DB / 100 m	DB / 100 ft	kW
30	2.2	0.7	3.33
50	2.9	0.9	2.57
150	5.0	1.5	1.47
220	6.1	1.9	1.20
450	8.9	2.7	0.83
900	12.8	3.9	0.58
1500	16.8	5.1	0.44
1800	18.6	5.7	0.40
2000	19.6	6.0	0.37
2500	22.2	6.8	0.33
5800	35.5	10.8	0.21

<sup>(\*)</sup> = Avg power calculated at sea level / 40°C and VSWR 1:0

[Cable-assembly power ratings may be limited by the connector type. Please contact us for specific needs]

*Flexible low loss cable 15/50 S+F  
(AEP-600FR alternative to LMR-600FR®)*



**P/N: C291 327 050**

**APPLICATION NOTE**

AEP-600FR cable is an alternative solution to 50 Ohms LMR-600FR® cable offering the same performance and similar construction with cost advantage.

**REGULATIONS**

RoHS compliant  
UL/NEC: CMR  
UL/CSA: FT4

**CONNECTORS COMPATIBLE  
WITH AEP-600FR  
(and to LMR® 600FR)**

**N Series**

P/N	Interface	Model
R161 079 200	Straight plug	Crimp type
R161 188 200	R/A plug	Crimp type
R161 331 400	Straight BH jack	Crimp type

**QN Series**

P/N	Interface	Model
R164 080 030	Straight plug	Crimp type

**7/16 Series**

P/N	Interface	Model
R185 077 010	Straight plug	Crimp type

<sup>(1)</sup> BCCAL = Copper Clad Aluminum

<sup>(2)</sup> PE = PolyEthylene

**CONSTRUCTION / DIMENSIONS**

	Material	mm	Inches
Center conductor	Solid BCCAL (1)	4.47	0.176
Dielectric	Foam PE(2)	11.56	0.455
Inner shield	Aluminum Tape	11.71	0.461
Outer shield	Tinned Copper braid	12.45	0.49
Outer jacket	Black LSZH	14.99	0.59

**ELECTRICAL CHARACTERISTICS**

Characteristic impedance	50 ohms	
Operating frequency range	DC - 6 GHz	
Dielectric constant	1.32	
Screening effectiveness	> 90 dB	
Velocity of propagation	87 %	
Capacitance	76.6 pF / m	23.4 pF / ft
Inductance	0.19 uH / m	0.058 uH / ft
Time delay	3.83 nS / m	1.17 nS / ft
Inner conductor DC resistance	1.7 ohms / km	0.53 ohms / 1000 ft
Outer conductor DC resistance	3.9 ohms / km	1.2 ohms / 1000 ft
Voltage withstand	4000 Volts DC	
Jacket spark	8000 Volts RMS	
Peak power	40kW	
Phase stability over temp	< 25 ppm / deg C	

**MECHANICAL CHARACTERISTICS**

Maximum weight	0.20 kg / m	0.131 lb / ft
Min. bend radius: installation	38.1 mm	1.50 inch
Min. bend radius: repeated	152.4 mm	6.0 inch
Bending moment	3.73 N-m	2.75 ft-lb
Tensile strength	158.9 kg	350 lb
Flat plate crush	1.07 kg / mm	60 lb / inch

**ENVIRONMENTAL CHARACTERISTICS**

Installation temperature range	-40 / +85 °C	-40 / +185 °F
Storage temperature range	-70 / +85 °C	-94 / +185 °F
Operating temperature range	-40 / +85 °C	-40 / +185 °F

**FREQUENCY / ATTENUATION (typ.) /  
AVG POWER (\*)**

MHz	DB / 100 m	DB / 100 ft	kW
30	1.4	0.4	5.51
50	1.8	0.5	4.24
150	3.2	1.0	2.41
220	3.9	1.2	1.97
450	5.6	1.7	1.35
900	8.2	2.5	0.93
1500	10.9	3.3	0.70
1800	12.1	3.7	0.63
2000	12.8	3.9	0.59
2500	14.5	4.4	0.52
5800	23.8	7.3	0.32

<sup>(\*)</sup> = Avg power calculated at sea level / 40°C and VSWR 1:0

(Cable-assembly power ratings may be limited by the connector type. Please contact us for specific needs)

## Connectors

The unique design of SHF cables allows for the use of custom-designed connectors. At Radiall, we pay particular attention to the design and to termination techniques to ensure low VSWR and superior cable performance.

Our cable /connector terminations are designed to maintain shield integrity into the lowest leakage attainable in a flexible assembly. All electrical connections (center contact and inner tape shield) are soldered.

Most popular connector interfaces to fit SHF cable are SMPM, SMP, SSMA, SMA, QRE, TNC, and N Type.

## SHF Cable Range

### Ultra low loss flexible cable



Cable	VP	Max Dia.	Attenuation	Bending radius	Weight
<b>SHF2.4M</b>	<b>76%</b>	<b>2.45mm</b>	<b>4.59 dB/m @ 40GHz</b>	<b>10mm</b>	<b>20 g/m</b>
DC-40GHz		0.095in	139 dB/100ft	0.394in	6.1 g/ft
<b>SHF2.9M</b> <sup>(2)</sup>	<b>75%</b>	<b>2.90mm</b>	<b>5.92 dB/m @ 67GHz</b>	<b>25mm</b>	<b>23 g/m</b>
DC-67GHz		0.114in	179 dB/100ft	0.984in	7.01 g/ft
<b>SHF3M</b>	<b>76%</b>	<b>3.64mm</b>	<b>2.76 dB/m @ 40GHz</b>	<b>12.5mm</b>	<b>35 g/m</b>
DC-40GHz		0.139in	84 dB/100ft	0.492in	10.6 g/ft
<b>SHF4M</b> <sup>(2)</sup>	<b>84%</b>	<b>4.15mm</b>	<b>2.05 dB/m @ 40GHz</b>	<b>20mm</b>	<b>40 g/m</b>
DC-40GHz		0.160in	62 dB/100ft	0.788in	12.2 g/ft
<b>SHF4.2M</b>	<b>76%</b>	<b>4.20mm</b>	<b>1.96 dB/m @ 26.5GHz</b>	<b>25mm</b>	<b>45 g/m</b>
DC-26.5GHz		0.165in	60 dB/100ft	0.984in	13.6 g/ft
<b>SHF4.6M</b>	<b>84%</b>	<b>4.65mm</b>	<b>1.69 dB/m @ 32GHz</b>	<b>25mm</b>	<b>41 g/m</b>
DC-32GHz		0.183in	51 dB/100ft	0.984in	12.5 g/ft
<b>SHF5M</b>	<b>84%</b>	<b>5.20mm</b>	<b>1.27 dB/m @ 26.5GHz</b>	<b>25mm</b>	<b>60 g/m</b>
DC-26.5GHz		0.201in	39 dB/100ft	0.984	18.2 g/ft
<b>SHF8M</b>	<b>84%</b>	<b>7.78mm</b>	<b>0.68 dB/m @ 18GHz</b>	<b>40mm</b>	<b>130 g/m</b>
DC-18GHz		0.302in	21 dB/100ft	1.575in	39.4 g/ft
<b>SHF13</b>	<b>85%</b>	<b>13.80mm</b>	<b>0.33 dB/m @ 9.5GHz</b>	<b>60mm</b>	<b>280 g/m</b>
DC-9.5GHz		0.543in	9 dB/100ft	2.362in	84.8 g/ft

<sup>(2)</sup> Triple shield structure

<sup>(1)</sup> SPC: Silver Plated Copper

## SHF Cable Range

**Stranded Inner Conductor Cable**

Using stranded center conductor allow better flexibility while keeping good IL performance level.

**Longer flex life**  
SHF3, SHF5, SHF8

**Ultra Flexible Cable**

Unique design of center conductor as well as braiding and jacketing provide a unique flexibility behavior to SHF UF.

**Low bending moment**  
**Up to 1 million flexures**  
SHF2.2UF, SHF3UF, SHF5UF

**Heavy Duty Protective Jacket**

Projack provides the highest mechanical protection to SHF cables. Despite this high protection level, Projack maintains the same level of flexibility as the original cable.

**Crush resistant 2500N/10cm**  
**UV resistant**  
**Watertightness**

**A/10 Armored Cable**

In many customer applications, mechanical stress may damage cable assemblies. Radiall has designed several levels of armored structures embedding SHF core lines.

**Crush resistant**  
**1000N/10cm**  
**Abrasion resistant**  
SHF5MA/10, SHF8MA/10

**OD Outdoor Cable**

Designed for outdoor environments, Radiall's outdoor cables are typically used for Ground Radars and Navy systems.

**UV resistant**  
**Watertightness**  
SHF5OD, SHF5MOD  
SHF8OD, SHF8MOD

**LW-2 Light Weight Cable**

Radiall's Lightweight range is the best choice for on-board equipment, where weight and density are critical.

**30% weight saving**  
SHF5MLW-2, SHF8MLW-2

**AF-2 Air Frame Cable**

SHF AirFrame cables: Robustness for extended life in extreme condition. Radiall's AirFrame cables are used in non-pressurized or not-protected areas.

**Hermetically sealed**  
**15 Km (50,000 ft) - 150°C**  
**Fluid resistant**  
SHF5MAF-2, SHF8MAF-2

Ultra Low Loss SHF Cable Range

Attenuation (dB/m)

GHz	SHF2.4M	SHF2.9M	SHF3M	SHF4M	SHF4.2M	SHF4.6M	SHF5M	SHF8M	SHF13
1.0	0.62	0.62	0.40	0.30	0.38	0.25	0.23	0.15	0.09
2.0	0.89	0.88	0.58	0.43	0.54	0.36	0.32	0.21	0.14
4.0	1.28	1.26	0.84	0.61	0.79	0.52	0.46	0.30	0.20
6.0	1.59	1.56	1.05	0.76	0.99	0.65	0.57	0.37	0.26
8.0	1.86	1.82	1.23	0.88	1.16	0.76	0.66	0.44	0.30
12.4	2.36	2.30	1.59	1.10	1.50	0.98	0.84	0.55	-
18.0	2.91	2.82	1.97	1.35	1.87	1.21	1.02	0.68	-
26.5	3.62	3.49	2.49	1.66	2.36	1.51	1.27	-	-
32.0	4.03	3.87	2.79	1.83	-	1.69	-	-	-
40.0	4.59	4.39	3.20	2.07	-	-	-	-	-
50.0	-	4.99	-	-	-	-	-	-	-
67.0	-	5.92	-	-	-	-	-	-	-

Attenuation (dB/100 ft)

GHz	SHF2.4M	SHF2.9M	SHF3M	SHF4M	SHF4.2M	SHF4.6M	SHF5M	SHF8M	SHF13
1.0	18.90	18.90	12.19	9.14	11.58	7.62	7.01	4.57	2.74
2.0	27.13	26.82	17.68	13.11	16.46	10.97	9.75	6.40	4.27
4.0	39.01	38.40	25.60	18.59	24.08	15.85	14.02	9.14	6.10
6.0	48.46	47.55	32.00	23.16	30.18	19.81	17.37	11.28	7.92
8.0	56.69	55.47	37.49	26.82	35.36	23.16	20.12	13.41	9.14
12.4	71.93	70.10	48.46	33.53	45.72	29.87	25.60	16.76	-
18.0	88.70	85.95	60.05	41.15	57.00	36.88	31.09	-	-
26.5	110.34	106.38	75.90	50.60	71.93	46.02	38.71	-	-
32.0	122.83	117.96	85.04	55.78	-	51.51	-	-	-
40.0	139.90	133.81	97.54	63.09	-	-	-	-	-
50.0	-	152.10	-	-	-	-	-	-	-
67.0	-	180.44	-	-	-	-	-	-	-

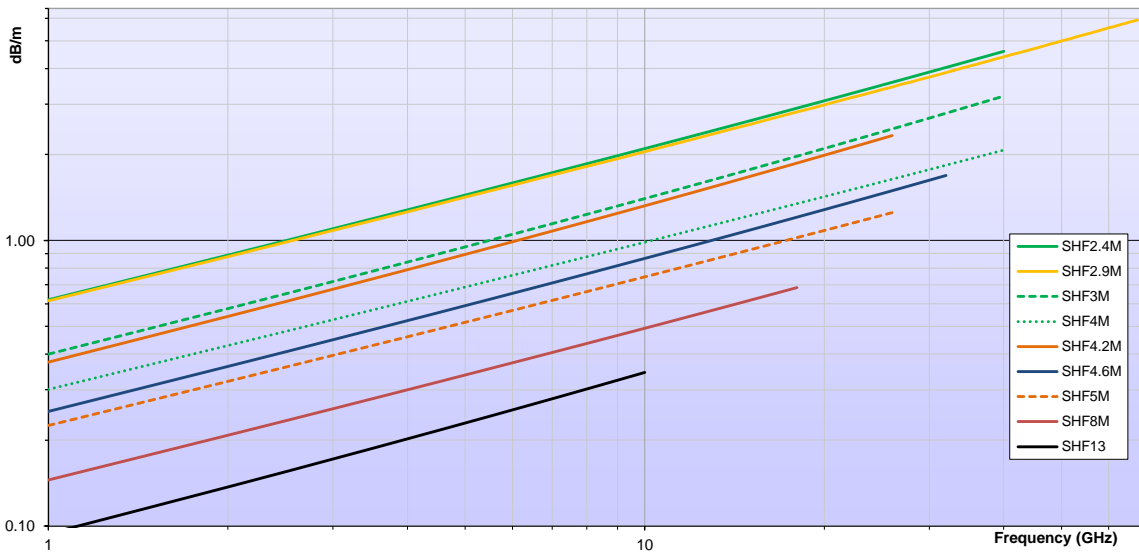



Ultra Low Loss SHF Cable Range

Power (W)

GHz	SHF2.4M	SHF2.9M	SHF3M	SHF4M	SHF4.2M	SHF4.6M	SHF5M	SHF8M	SHF13
1.0	260	260	400	475	630	422	850	1600	2500
2.0	184	184	283	336	445	298	601	1131	1768
4.0	130	130	200	238	315	211	425	800	1250
6.0	106	106	163	194	257	172	347	653	1021
8.0	92	92	141	168	223	149	301	566	884
12.4	74	74	114	135	179	120	241	454	-
18.0	61	61	94	112	148	99	200	377	-
26.5	51	51	78	92	122	82	165	-	-
32.0	46	46	71	84	-	75	-	-	-
40.0	41	41	63	75	-	-	-	-	-
50.0	-	37	-	-	-	-	-	-	-
67.0	-	32	-	-	-	-	-	-	-

(\*) CW max power calculated at sea level / 40°C and V.S.W.R. 1:1  
Cable assembly power rating may be limited by connector type

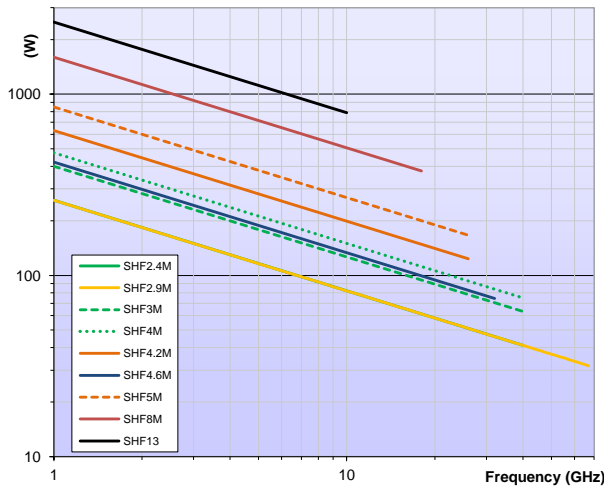

Phase change vs temperature

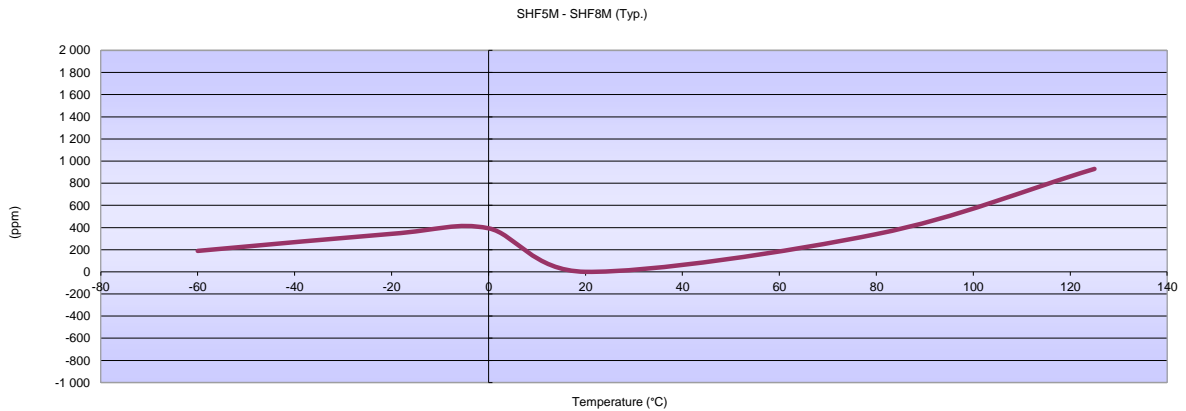

NOTE

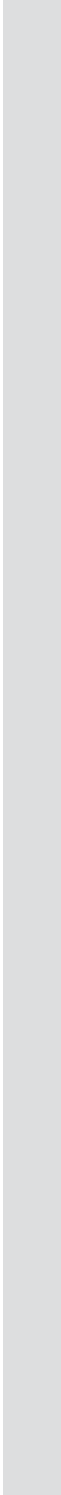

# NOTE





## MICROWAVE COMPONENTS

R404/R41X

**Contents**

**TERMINATIONS**

Introduction..... 19-4  
Low power terminations, up to 3 watts ..... 19-5 to 19-7  
Medium power terminations, up to 30 watts ..... 19-7 to 19-8  
High power terminations, up to 1000 watts ..... 19-8 to 19-9  
Platinum terminations, up to 1 Watt ..... 19-10

**ATTENUATORS**

Introduction..... 19-10  
Low power attenuators, up to 2 watts ..... 19-11 to 19-13  
Medium power attenuators, up to 30 watts..... 19-14  
High power attenuators, up to 100 watts ..... 19-5 to 19-16  
Platinum attenuators, up to 2 Watts ..... 19-17

**COUPLERS & SPECIAL DEVICES**

Introduction..... 19-17  
Couplers ..... 19-18 to 19-19  
Special devices ..... 19-20 to 19-21

INDEX ..... 19-22



## Introduction

Radiall coaxial terminations offer excellent reliability and repeatability from DC to 50 GHz. The offer includes low, medium, high power terminations, and a platinum range for instrumentation applications which provide the lowest VSWR.

### Here are the main features of Radiall's terminations:

- Power range from 0.5W to 1000W
- Frequency from DC up to 50 GHz
- 50Ω Impedance
- High repeatability
- Compatible with all standard connector interfaces
- Connector interface according to applicable MIL, DIN, NF and CEI
- Dedicated Platinum range for Test & Measurement providing lowest VSWR

### LOW POWER TERMINATIONS



Power	0.5 to 3 Watts
Connectors	BMA, BNC, QMA, QN, N, SMA, SMA2.9, SMB, SMP, SSMA, TNC, 1.0/2.3
Frequency range	DC to 50 GHz

### MEDIUM POWER TERMINATIONS



Power	6 to 30 Watts
Connectors	BNC, N, SMA, TNC, 7/16
Frequency range	DC to 18 GHz

### HIGH POWER TERMINATIONS



Power	50 to 1000 Watts
Connectors	N, SMA, TNC, 7/16
Frequency range	DC to 6 GHz

### PLATINUM TERMINATIONS

Radiall's low power terminations offer is dedicated for Test & Measurement and provides the lowest VSWR.



Power	1 Watt
Connectors	SMA2.9, SMA3.5, SMA, N, BNC, TNC
Frequency	DC to 40 GHz



Low Power Terminations, up to 3 Watts

1.0/2.3 - 50 OHMS

Frequency DC to (GHz)	VSWR max.	Return loss min. (dB)	Power rating (W)		Impedance (Ω)	Gender	Part number
			Avg. (W)	Peak (W)			
2.5	1.15	23.1	1	100	50±5%	Male	R404 144 000

7/16 - 50 OHMS

Frequency DC to (GHz)	VSWR max.	Return loss min. (dB)	Power rating (W)		Impedance (Ω)	Gender	Part number
			Avg. (W)	Peak (W)			
4	1.15	23.1	2	500	50±5%	Male	R404 170 111
4	1.15	23.1	2	500	50±5%	Female	R404 175 111

BMA - 50 OHMS

Frequency DC to (GHz)	VSWR max.	Return loss min. (dB)	Power rating (W)		Impedance (Ω)	Gender	Part number
			Avg. (W)	Peak (W)			
18	1.2	20.8	1	100	50±5%	Male	R404 270 000
18	1.3	17.7	1	100	50±5%	Female	R404 275 000

BNC - 50 AND 75 OHMS

Frequency DC to (GHz)	VSWR max.	Return loss min. (dB)	Power rating (W)		Impedance (Ω)	Gender	Part number
			Avg. (W)	Peak (W)			
1	-	-	1	500	50±1%	Male	R404 441 000 <sup>(3)</sup>
1	-	-	1	500	50±1%	Male	R404 441 120 <sup>(1) (3)</sup>
1	-	-	1	500	50±1%	Male	R404 441 121 <sup>(2) (3)</sup>
4	1.2	20.8	1	100	50±2%	Male	R404 111 000
4	1.2	20.8	1	100	50±2%	Male	R404 111 120 <sup>(1)</sup>
4	1.2	20.8	1	100	50±2%	Female	R404 112 000
8	1.25	19.1	1	1,000	50±5%	Male	R404 110 000
8	1.25	19.1	1	1,000	50±5%	Male	R404 110 120 <sup>(1)</sup>
1	1.15	23.1	1	500	75±5%	Male	R404 012 000
1	1.15	23.1	1	500	75±5%	Male	R404 012 120
1	1.15	23.1	1	500	75±5%	Female	R404 014 000
1	-	-	1	500	75±0.1%	Male	R404 4120 00 <sup>(3)</sup>
1	-	-	1	500	75±1%	Male	R404 442 000 <sup>(3)</sup>
1	-	-	1	500	75±1%	Male	R404 442 120 <sup>(1) (3)</sup>

(1) with bead chain, (2) with cord, (3) resistive pad

N - 50 OHMS

Frequency DC to (GHz)	VSWR max.	Return loss min. (dB)	Power rating (W)		Impedance (Ω)	Gender	Part number
			Avg. (W)	Peak (W)			
4	1.2	20.8	1	500	50±2%	Male	R404 131 000
4	1.2	20.8	1	500	50±2%	Male	R404 131 120 <sup>(1)</sup>
4	1.2	20.8	1	500	50±2%	Female	R404 132 000
12.4	1.15	23.1	1	500	50±2%	Male	R404 240 000
12.4	1.15	23.1	1	500	50±2%	Male	R404 240 120 <sup>(1)</sup>
12.4	1.15	23.1	1	500	50±2%	Male	R404 240 121 <sup>(2)</sup>
12.4	1.15	23.1	1	500	50±2%	Female	R404 245 000
18	1.2	20.8	2	100	50±2%	Male	R404 340 000
18	1.2	20.8	2	100	50±2%	Male	R404 340 120 <sup>(1)</sup>
18	1.2	20.8	2	100	50±2%	Female	R404 355 000

(1) with bead chain, (2) with cord

QMA - 50 OHMS

Frequency DC to (GHz)	VSWR max.	Return loss min. (dB)	Power rating (W)		Impedance (Ω)	Gender	Part number
			Avg. (W)	Peak (W)			
3	1.1	26.4	2	200	50±5%	Male	R404 114 111
4	1.2	20.8	1	100	50±5%	Male	R404 114 000
4	1.2	20.8	1	100	50±5%	Male	R404 114 120 <sup>(1)</sup>

(1) with bead chain



## Low Power Terminations, up to 3 Watts

### QN - 50 OHMS

Frequency DC to (GHz)	VSWR max.	Return loss min. (dB)	Power rating (W)		Impedance ( $\Omega$ )	Gender	Part number
			Avg. (W)	Peak (W)			
4	1.2	20.8	1	100	50 $\pm$ 5%	Male	R404 116 000

### SMA - 50 OHMS

Frequency DC to (GHz)	VSWR max.	Return loss min. (dB)	Power rating (W)		Impedance ( $\Omega$ )	Gender	Part number
			Avg. (W)	Peak (W)			
4	1.2	20.8	1	100	50 $\pm$ 5%	Male	R404 101 000
4	1.2	20.8	1	100		Male	R404 101 120 <sup>(1)</sup>
4	1.25	19.1	1	100		Female	R404 102 000
8	1.15	23.1	3	250		Male	R404 600 000
18	1.2	20.8	1	100		Male	R404 N05 000
18	1.2	20.8	1	100		Male	R404 N05 120 <sup>(1)</sup>
18	1.2	20.8	1	100		Male	R404 N05 121 <sup>(2)</sup>
18	1.2	20.8	1	100		Female	R404 N06 000
18	1.2	20.8	2	100		Male	R404 N01 000
18	1.2	20.8	2	100		Male	R404 N01 120 <sup>(1)</sup>
18	1.2	20.8	2	100		Male	R404 N01 121 <sup>(2)</sup>
18	1.2	20.8	2	100		Female	R404 N02 000
18	1.34	16.8	3	250		Male	R404 605 000
26.5	1.3	17.7	1	100		Male	R404 N07 000
26.5	1.3	17.7	1	100		Female	R404 N08 000
26.5	1.3	17.7	2	100		Male	R404 N03 000
26.5	1.3	17.7	2	100		Female	R404 N04 000
18	1.15		1	100		Male	9620-9003-151
18	1.15		1	100		Male	9620-9003-251

(1) with bead chain, (2) with cord

### SMA2.9 - 50 OHMS

Frequency DC to (GHz)	VSWR max.	Return loss min. (dB)	Power rating (W)		Impedance ( $\Omega$ )	Gender	Part number
			Avg. (W)	Peak (W)			
40	1.35	16.5	1	100	50 $\pm$ 5%	Male	R404 280 000
40	1.35	16.5	1	100	50 $\pm$ 5%	Female	R404 285 000

### SMB - 50 OHMS

Frequency DC to (GHz)	VSWR max.	Return loss min. (dB)	Power rating (W)		Impedance ( $\Omega$ )	Gender	Part number
			Avg. (W)	Peak (W)			
4	1.2	20.8	1	100	50 $\pm$ 5%	Male	R404 104 000
4	1.2	20.8	1	100	50 $\pm$ 5%	Female	R404 105 000
8	1.25	19.1	0.5	100	50 $\pm$ 5%	Female	R404 155 000 <sup>(2)</sup>
8	1.25	19.1	0.5	100	50 $\pm$ 5%	Female	R404 165 000

(2) with cord

### SMC - 50 OHMS

Frequency DC to (GHz)	VSWR max.	Return loss min. (dB)	Power rating (W)		Impedance ( $\Omega$ )	Gender	Part number
			Avg. (W)	Peak (W)			
8	1.25	19.1	0.5	100	50 $\pm$ 5%	Female	R404 160 000 1036-1511-051





Low Power Terminations, up to 3 Watts

**SMP - 50 OHMS**

Frequency DC to (GHz)	VSWR max.	Return loss min. (dB)	Power rating (W)		Impedance (Ω)	Gender	Part number
			Avg. (W)	Peak (W)			
18	1.3	17.7	1	100	50±5%	Male	R404 N61 000
18	1.3	17.7	1	100	50±5%	Female	R404 N62 000
40	1.7	11.7	0.5	100	50±5%	Male	R404 260 000
40	1.7	11.7	0.5	100	50±5%	Female	R404 262 000

**SSMA - 50 OHMS**

Frequency DC to (GHz)	VSWR max.	Return loss min. (dB)	Power rating (W)		Impedance (Ω)	Gender	Part number
			Avg. (W)	Peak (W)			
18	1.35	16.5	0.5	100	50±5%	Male	R404 380 000

**TNC - 50 OHMS**

Frequency DC to (GHz)	VSWR max.	Return loss min. (dB)	Power rating (W)		Impedance (Ω)	Gender	Part number
			Avg. (W)	Peak (W)			
4	1.2	20.8	1	100	50±2%	Male	R404 121 000
4	1.2	20.8	1	100	50±2%	Male	R404 121 120 <sup>(1)</sup>
4	1.2	20.8	1	100	50±2%	Female	R404 122 000
12.4	1.25	19.1	1	500	50±5%	Male	R404 225 000
12.4	1.25	19.1	1	500	50±5%	Male	R404 225 120 <sup>(1)</sup>
18	1.2	20.8	2	100	50±5%	Male	R404 370 000
18	1.2	20.8	2	100	50±5%	Male	R404 370 120 <sup>(1)</sup>
18	1.2	20.8	2	100	50±5%	Female	R404 375 000

(1) with bead chain

**4.3/10 - 50 OHMS**

Frequency DC to (GHz)	VSWR max.	Return loss min. (dB)	Power rating (W)		Impedance (Ω)	Gender	Part number
			Avg. (W)	Peak (W)			
6	1.25	19.1	2	500	50±5%	Male screw	R4041D1000
6	1.25	19.1	2	500	50±5%	Male screw	R4041D1121 <sup>(2)</sup>
6	1.25	19.1	2	500	50±5%	Male push-pull	R4041D2000
6	1.25	19.1	2	500	50±5%	Male push-pull	R4041D2121 <sup>(2)</sup>
6	1.25	19.1	2	500	50±5%	Female	R4041D5000

(2) with cord

Medium Power Terminations, up to 30 Watts

**7/16 - 50 OHMS**

Frequency DC to (GHz)	VSWR max.	Return loss min. (dB)	Power rating (W)		Impedance (Ω)	Gender	Part number
			Avg. (W)	Peak (W)			
6	1.3	17.7	30	2,000	50±5%	Male	R404 756 000
4	1.2	20.8	12	4,000	50±5%	Male	R404 564 000

**BNC - 50 OHMS**

Frequency DC to (GHz)	VSWR max.	Return loss min. (dB)	Power rating (W)		Impedance (Ω)	Gender	Part number
			Avg. (W)	Peak (W)			
2	1.1	26.4	6	4,000	50±5%	Male	R404 505 000
2	1.1	26.4	12	4,000	50±5%	Male	R404 555 000
8	1.25	19.1	6	4,000	50±5%	Male	R404 510 000
8	1.25	19.1	12	4,000	50±5%	Male	R404 560 000



## Medium Power Terminations, up to 30 Watts

### N - 50 OHMS

Frequency DC to (GHz)	VSWR max.	Return loss min. (dB)	Power rating (W)		Impedance (Ω)	Gender	Part number
			Avg. (W)	Peak (W)			
2	1.1	26.4	6	4,000	50±5%	Male	R404 507 000
2	1.1	26.4	12	4,000	50±5%	Male	R404 557 000
6	1.3	17.7	30	2,000	50±5%	Male	R404 750 000
6	1.3	17.7	30	2,000	50±5%	Female	R404 751 000
12.4	1.3	17.7	6	4,000	50±5%	Male	R404 517 000
12.4	1.3	17.7	12	4,000	50±5%	Male	R404 567 000
12.4	1.25	19.1	20	300	50±5%	Male	R404 587 000
12.4	1.25	19.1	20	300	50±5%	Female	R404 587 500
18	1.3	17.7	6	300	50±5%	Male	R404 522 000
18	1.3	17.7	12	300	50±5%	Male	R404 572 000
18	1.35	16.5	20	300	50±5%	Male	R404 588 000
18	1.35	16.5	20	300	50±5%	Female	R404 588 500

### TNC - 50 OHMS

Frequency DC to (GHz)	VSWR max.	Return loss min. (dB)	Power rating (W)		Impedance (Ω)	Gender	Part number
			Avg. (W)	Peak (W)			
2	1.1	26.4	6	4,000	50±5%	Male	R404 506 000
2	1.1	26.4	12	4,000	50±5%	Male	R404 556 000
6	1.3	17.7	30	2,000	50±5%	Male	R404 752 000
6	1.3	17.7	30	2,000	50±5%	Female	R404 753 000
12.4	1.3	17.7	6	4,000	50±5%	Male	R404 516 000
12.4	1.3	17.7	12	4,000	50±5%	Male	R404 566 000
12.4	1.25	19.1	20	300	50±5%	Male	R404 585 000
12.4	1.25	19.1	20	300	50±5%	Female	R404 585 500
18	1.3	17.7	12	300	50±5%	Male	R404 571 000
18	1.35	16.5	20	300	50±5%	Male	R404 586 000
18	1.35	16.5	20	300	50±5%	Male	R404 586 500

### 4.3/10 - 50 OHMS

Frequency DC to (GHz)	VSWR max.	Return loss min. (dB)	Power rating (W)		Impedance (Ω)	Gender	Part number
			Avg. (W)	Peak (W)			
6	1.3	17.7	30	2,000	50±5%	Male screw	R404 758 000
6	1.3	17.7	30	2,000	50±5%	Female	R404 759 000

## High Power Terminations, up to 1000 Watts

### 7/16 - 50 OHMS

Frequency DC to (GHz)	VSWR max.	Return loss min. (dB)	Power rating (W)		Impedance (Ω)	Gender	Part number	Weight (g)
			Avg. (W)	Peak (W)				
1	1.1	26.4	1000	40,000	50±5%	Female	R404 867 000	15,000
2.5	1.3	17.7	600	40,000	50±5%	Female	R404 865 000	8,200
6	1.3	17.7	50	200	50±5%	Male	R404 766 000	260
6	1.3	17.7	50	200	50±5%	Female	R404 767 000	250
6	1.3	17.7	100	200	50±5%	Male	R404 776 000	1,300
6	1.3	17.7	100	200	50±5%	Female	R404 777 000	1,300
6	1.3	17.7	150	2,000	50±5%	Male	R404 786 000	1,500
6	1.3	17.7	150	2,000	50±5%	Female	R404 787 000	1,500
6	1.3	17.7	200	2,000	50±5%	Male	R404 786 020	2,000
6	1.3	17.7	200	2,000	50±5%	Female	R404 787 020	2,000

### 7/16 - 50 OHMS CONDUCTION COOLING

Frequency DC to (GHz)	VSWR max.	Return loss min. (dB)	Power rating (W)		Impedance (Ω)	Gender	Part number	Weight (g)
			Avg. (W)	Peak (W)				
6	1.3	17.7	200	2,000	50±5%	Male	R404 786 120	140
6	1.3	17.7	200	2,000	50±5%	Female	R404 787 120	140



High Power Terminations, up to 1000 Watts

**N - 50 OHMS**

Frequency DC to (GHz)	VSWR max.	Return loss min. (dB)	Power rating (W)		Impedance (Ω)	Gender	Part number	Weight (g)
			Avg. (W)	Peak (W)				
2.5	1.3	17.7	400	40,000	50±5%	Female	R404 863 000	4,200
6	1.3	17.7	50	2,000	50±5%	Male	R404 760 000	210
6	1.3	17.7	50	2,000	50±5%	Female	R404 761 000	200
6	1.3	17.7	100	2,000	50±5%	Male	R404 770 000	1,200
6	1.3	17.7	100	2,000	50±5%	Female	R404771000	1,200
6	1.3	17.7	150	2,000	50±5%	Male	R404780000	1,500
6	1.3	17.7	150	2,000	50±5%	Female	R404781000	1,500
6	1.3	17.7	200	2,000	50±5%	Male	R404780020	2,000
6	1.3	17.7	200	2,000	50±5%	Female	R404781020	2,000
6	1.2	20.8	250		50±5%	Female	R404861000	3,000

**N - 50 OHMS CONDUCTION COOLING**

Frequency DC to (GHz)	VSWR max.	Return loss min. (dB)	Power rating (W)		Impedance (Ω)	Gender	Part number	Weight (g)
			Avg. (W)	Peak (W)				
6	1.3	17.7	200	2,000	50±5%	Male	R404 780 120	140
6	1.3	17.7	200	2,000	50±5%	Female	R404 781 120	140

**SMA - 50 OHMS**

Frequency DC to (GHz)	VSWR max.	Return loss min. (dB)	Power rating (W)		Impedance (Ω)	Gender	Part number	Weight (g)
			Avg. (W)	Peak (W)				
6	1.3	17.7	50	200	50±5%	Male	R404 764 000	200
6	1.3	17.7	50	200	50±5%	Female	R404 765 000	200
6	1.3	17.7	100	200	50±5%	Male	R404 774 000	1,200
6	1.3	17.7	100	200	50±5%	Female	R404 775 000	1,200

**TNC - 50 OHMS**

Frequency DC to (GHz)	VSWR max.	Return loss min. (dB)	Power rating (W)		Impedance (Ω)	Gender	Part number	Weight (g)
			Avg. (W)	Peak (W)				
6	1.3	17.7	50	200	50±5%	Male	R404 762 000	200
6	1.3	17.7	50	200	50±5%	Female	R404 763 000	200
6	1.3	17.7	100	200	50±5%	Male	R404 772 000	1,200
6	1.3	17.7	100	200	50±5%	Female	R404 773 000	1,200
6	1.3	17.7	150	2,000	50±5%	Male	R404 782 000	1,500
6	1.3	17.7	150	2,000	50±5%	Female	R404 783 000	1,500
6	1.3	17.7	200	2,000	50±5%	Male	R404 782 020	1,900
6	1.3	17.7	200	2,000	50±5%	Female	R404 783 020	1,900

**TNC - 50 OHMS CONDUCTION COOLING**

Frequency DC to (GHz)	VSWR max.	Return loss min. (dB)	Power rating (W)		Impedance (Ω)	Gender	Part number	Weight (g)
			Avg. (W)	Peak (W)				
6	1.3	17.7	200	2,000	50±5%	Male	R404 782 120	140
6	1.3	17.7	200	2,000	50±5%	Female	R404 783 120	140

**4.3/10 - 50 OHMS**

Frequency DC to (GHz)	VSWR max.	Return loss min. (dB)	Power rating (W)		Impedance (Ω)	Gender	Part number	Weight (g)
			Avg. (W)	Peak (W)				
6	1.3	17.7	50	200	50±5%	Male screw	R404 768 000	200
6	1.3	17.7	50	200	50±5%	Female	R404 769 000	200
6	1.3	17.7	100	200	50±5%	Male screw	R404 778 000	1,200
6	1.3	17.7	100	200	50±5%	Female	R404 779 000	1,200



## Platinum Terminations, up to 1 Watt

Radiall's platinum series of terminations is designed for test & measurement applications. This range can be easily integrated in communication matrices, test benches and laboratories where high RF performance and reliability are essential.

### Here are the main features of Radiall's platinum series of terminations:

- 1 W power rating
- Frequency from DC up to 40 GHz
- Lowest VSWR
- 50Ω Impedance
- Compatible with all standard Test & Measurement interfaces
- Full integration in Radiall Test & Measurement offer:  
Electro-mechanical switches & Testpro cable Assemblies



### SMA 2.9 - 50 OHMS

Frequency DC to (GHz)	VSWR max.	Return loss min. (dB)	Power rating (W)		Impedance (Ω)	Gender	Part number
			Avg. (W)	Peak (W)			
40	1.18	21.7	1	50	50±5%	Male	R404 280 150
40	1.22	20.1	1	50	50±5%	Female	R404 285 150

### SMA 3.5 - 50 OHMS

Frequency DC to (GHz)	VSWR max.	Return loss min. (dB)	Power rating (W)		Impedance (Ω)	Gender	Part number
			Avg. (W)	Peak (W)			
26.5	1.1	26.4	1	50	50±5%	Male	R404 211 150
26.5	1.12	24.9	1	50	50±5%	Female	R404 216 150

### SMA - 50 Ohms

Frequency DC to (GHz)	VSWR max.	Return loss min. (dB)	Power rating (W)		Impedance (Ω)	Gender	Part number
			Avg. (W)	Peak (W)			
18	1.1	26.4	1	50	50±5%	Male	R404 210 150
18	1.1	24.9	1	50	50±5%	Female	R404 215 150

### N - 50 Ohms

Frequency DC to (GHz)	VSWR max.	Return loss min. (dB)	Power rating (W)		Impedance (Ω)	Gender	Part number
			Avg. (W)	Peak (W)			
18	1.1	26.4	1	50	50±5%	Male	R404 350 150
18	1.1	24.9	1	50	50±5%	Female	R404 355 150

### TNC - 50 OHMS

Frequency DC to (GHz)	VSWR max.	Return loss min. (dB)	Power rating (W)		Impedance (Ω)	Gender	Part number
			Avg. (W)	Peak (W)			
12.4	1.15	23.1	1	50	50±5%	Male	R404 370 150
12.4	1.15	23.1	1	50	50±5%	Female	R404 375 150

### BNC - 50 OHMS

Frequency DC to (GHz)	VSWR max.	Return loss min. (dB)	Power rating (W)		Impedance (Ω)	Gender	Part number
			Avg. (W)	Peak (W)			
12.4	1.12	24.9	1	50	50±5%	Male	R404 110 150
12.4	1.12	24.9	1	50	50±5%	Female	R404 115 150



## Introduction

Radiall coaxial fixed attenuators offer excellent reliability and repeatability from DC to 40 GHz. The offer includes low, medium, high power attenuators and a platinum range for instrumentation applications which provide the lowest VSWR.

### Main attenuator features:

- Power range from 0.5W to 100W
- Frequency from DC up to 40 GHz
- Attenuation values from 0 up to 60 dB
- High repeatability
- 50Ω Impedance
- Compatible with all standard connector interfaces: BNC, QN, N, 7/16, SMA, TNC, SMA2.9
- Dedicated Platinum range for Test & Measurement providing lowest VSWR

## LOW POWER ATTENUATORS



Power	0.5 to 2 Watts
Connectors	BNC, QN, N, SMA, SMA2.9, SMB, TNC, 7/16
Frequency range	DC to 40 GHz
Attenuation range	0 to 60 dB

## MEDIUM POWER ATTENUATORS



Power	3 to 50 Watts
Connectors	BNC, N, SMA, TNC, 7/16
Frequency range	DC to 18 GHz
Attenuation range	0 to 30 dB

## HIGH POWER ATTENUATORS



Power	80 to 100 Watts
Connectors	N, SMA, TNC, 7/16
Frequency range	DC to 6 GHz
Attenuation range	0 to 20 dB

## PLATINUM ATTENUATORS

Radiall's low power attenuator offer is dedicated for Test & Measurement and provides the lowest VSWR.



Power	2 Watts
Connectors	SMA2.9, SMA3.5, SMA, N, BNC, TNC
Frequency range	DC to 40 GHz
Attenuation range	0 to 30 dB



## Low Power Attenuators, up to 2 Watts

### 7/16 - 50 OHMS, MALE TO FEMALE

Frequency DC to (GHz)	VSWR max.	Return loss min. (dB)	Power rating (W)		Nom. Attenuation (dB)	Max dev.	Part number
			Avg. (W)	Peak (W)			
3	1.3	17.7	1	100	xx	± 0.5 <sup>(1)</sup>	R412 8xx 000
Available attenuation value: xx = 03, 06, 10 and 20 dB							

<sup>(1)</sup> ± 1 for xx = 20

### BNC - 50 OHMS, MALE TO FEMALE

Frequency DC to (GHz)	VSWR max.	Return loss min. (dB)	Power rating (W)		Nom. Attenuation (dB)	Max dev.	Part number
			Avg. (W)	Peak (W)			
2	1.2	20.8	2	100	xx	± 0.35 <sup>(1)</sup>	R412 4xx 000
Available attenuation value: xx = 00 to 20 step 1, 30, 40 and 50 dB							
3	1.3	17.7	1	100	xx	± 0.5 <sup>(2)</sup>	R412 4xx 124
Available attenuation value: xx = 00 to 20 step 1 dB							
8	1.25	19.1	2	100	xx	± 0.5 <sup>(3)</sup>	R414 4xx 000
Available attenuation value: xx = 00 to 15 step 1, 20, 25, 30, 40 - 50 and 60 dB							

<sup>(1)</sup> up to xx = 14, <sup>(2)</sup> up to xx = 15, <sup>(3)</sup> up to xx = 25

### N - 50 OHMS, MALE TO FEMALE

Frequency DC to (GHz)	VSWR max.	Return loss min. (dB)	Power rating (W)		Nom. Attenuation (dB)	Max dev.	Part number
			Avg. (W)	Peak (W)			
2	1.15	23.1	2	100	xx	± 0.35 <sup>(1)</sup>	R412 7xx 000
Available attenuation value: xx = 00 to 15 step 1, 20, 30, 40 and 50 dB							
6	1.4	15.6	1	100	xx	± 0.5 <sup>(1)</sup>	R412 700 124
Available attenuation value: xx = 00 to 20 dB step 1							
12.4	1.4	15.6	2	100	xx	± 0.7 <sup>(2)</sup>	R414 7xx 000
Available attenuation value: xx = 00 to 15 step 1, 20, 25, 30, 40 - 50 and 60 dB							
18	1.35	16.5	2	100	xx	± 0.4 <sup>(3)</sup>	R414 7xx 161
Available attenuation value: xx = 00 to 20 dB step 1							

<sup>(1)</sup> up to xx = 15, <sup>(2)</sup> up to xx = 20, <sup>(3)</sup> up to xx = 6

### QMA - 50 OHMS, MALE TO FEMALE

Frequency DC to (GHz)	VSWR max.	Return loss min. (dB)	Power rating (W)		Nom. Attenuation (dB)	Max dev.	Part number
			Avg. (W)	Peak (W)			
6	1.3	17.7	1	100	xx	± 0.5 <sup>(1)</sup>	R411 7xx 124
Available attenuation value: xx = 00 to 20 dB step 1							

<sup>(1)</sup> up to xx = 15

### QN - 50 OHMS, MALE TO FEMALE

Frequency DC to (GHz)	VSWR max.	Return loss min. (dB)	Power rating (W)		Nom. Attenuation (dB)	Max dev.	Part number
			Avg. (W)	Peak (W)			
3	1.3	17.7	1	100	xx	± 0.5 <sup>(1)</sup>	R412 3xx 124
Available attenuation value: xx = 00 to 20 dB step 1							

<sup>(1)</sup> up to xx = 15

### SMA - 50 OHMS, MALE TO FEMALE, .75IN.

Frequency DC to (GHz)	VSWR max.	Return loss min. (dB)	Power rating (W)		Nom. Attenuation (dB)	Max dev.	Part number
			Avg. (W)	Peak (W)			
6	1.4	15.6	1	100	xx	± 0.5 <sup>(1)</sup>	R411 8xx 124
Available attenuation value: xx = 00 to 20 dB step 1							
12.4	1.3	17.7	2	100	xx	± 0.5 <sup>(2)</sup>	R411 8xx 119
Available attenuation value: xx = 00 to 20 step 1 and 30 dB							
18	1.35	16.5	2	100	xx	± 0.7 <sup>(3)</sup>	R411 8xx 121
Available attenuation value: xx = 00 to 20 step 1 and 30 dB							

<sup>(1)</sup> up to xx = 15, <sup>(2)</sup> up to xx = 10, <sup>(3)</sup> up to xx = 7



Low Power Attenuators, up to 2 Watts

**SMA - 50 OHMS, MALE TO FEMALE, .86IN.**

Frequency DC to (GHz)	VSWR max.	Return loss min. (dB)	Power rating (W)		Nom. Attenuation (dB)	Max dev.	Part number
			Avg. (W)	Peak (W)			
4	1.15	23.1	2	100	xx	± 0.3 <sup>(1)</sup>	R413 8xx 115
Available attenuation value: xx = 00 to 20 step 1, 30, 40 - 50 and 60 dB							
18	1.35	16.5	2	100	xx	± 0.3 <sup>(1)</sup>	R413 8xx 000
Available attenuation value: xx = 00 to 20 step 1, 25, 30, 35, 40, 45 - 50, 55 and 60 dB							
26.5	1.5	14.0	2	100	xx	± 0.5 <sup>(1)</sup>	R413 8xx 121
Available attenuation value: xx = 00 to 20 step 1, 25 and 30 dB							

<sup>(1)</sup> up to xx = 6

**SMA 2.9 - 50 OHMS, MALE TO FEMALE**

Frequency DC to (GHz)	VSWR max.	Return loss min. (dB)	Power rating (W)		Nom. Attenuation (dB)	Max dev.	Part number
			Avg. (W)	Peak (W)			
40	1.6	12.7	2	100	xx	± 0.8	R413 3xx 000
Available attenuation value: xx = 00 to 10 step 1 and 20 dB							

**SMB - 50 OHMS, MALE TO FEMALE**

Frequency DC to (GHz)	VSWR max.	Return loss min. (dB)	Power rating (W)		Nom. Attenuation (dB)	Max dev.	Part number
			Avg. (W)	Peak (W)			
8	1.3	17.7	2	100	xx	± 0.5	R410 2xx 121
Available attenuation value: xx = 03, 06, 10 and 20 dB							

**SMC - 50 OHMS, MALE TO FEMALE**

Frequency DC to (GHz)	VSWR max.	Return loss min. (dB)	Power rating (W)		Nom. Attenuation (dB)	Max dev.	Part number
			Avg. (W)	Peak (W)			
8	1.3	17.7	2	100	xx	± 0.5	R410 1xx 121
Available attenuation value: xx = 03, 06, 10 and 20 dB							

**TNC - 50 OHMS, MALE TO FEMALE**

Frequency DC to (GHz)	VSWR max.	Return loss min. (dB)	Power rating (W)		Nom. Attenuation (dB)	Max dev.	Part number
			Avg. (W)	Peak (W)			
2	1.15	23.1	2	100	xx	± 0.35 <sup>(1)</sup>	R412 5xx 000
Available attenuation value: xx = 00 to 15 step 1, 20, 30, 40 and 50 dB							
3	1.3	17.7	1	100	xx	± 0.5 <sup>(2)</sup>	R412 5xx 124
Available attenuation value: xx = 00 to 20 dB step 1							
12.4	1.3	17.7	2	100	xx	± 0.7 <sup>(3)</sup>	R414 5xx 000
Available attenuation value: xx = 00 to 15 step 1, 20, 25, 30, 40 - 50 and 60 dB							
18	1.35	16.5	2	100	xx	± 0.4 <sup>(4)</sup>	R414 5xx 161
Available attenuation value: xx = 00 to 20 dB step 1							

<sup>(1)</sup> up to xx = 15, <sup>(2)</sup> up to xx = 14, <sup>(3)</sup> up to xx = 6



## Medium Power Attenuators, up to 30 Watts

### 7/16 - 50 OHMS, MALE TO FEMALE

Frequency DC to (GHz)	VSWR max.	Return loss min. (dB)	Power rating (W)		Nom. Attenuation (dB)	Max dev.	Part number
			Avg. (W)	Peak (W)			
4	1.35	16.5	25	5,000	xx	± 0.6 <sup>(1)</sup>	R4203xx110
Available attenuation value: xx = 03, 06, 10 and 20 dB							

<sup>(1)</sup> ± 0.6 for xx = 20

### BNC - 50 OHMS, MALE TO FEMALE

Frequency DC to (GHz)	VSWR max.	Return loss min. (dB)	Power rating (W)		Nom. Attenuation (dB)	Max dev.	Part number
			Avg. (W)	Peak (W)			
4	1.3	17.7	15 <sup>(2)</sup>	250	xx	± 0.5	R4154xx000
Available attenuation value: xx = 03, 06, 10 and 20 dB							

<sup>(2)</sup> 12 for xx= 06 , 10 for xx = 10 and 20

### N - 50 OHMS, MALE TO FEMALE

Frequency DC to (GHz)	VSWR max.	Return loss min. (dB)	Power rating (W)		Nom. Attenuation (dB)	Max dev.	Part number
			Avg. (W)	Peak (W)			
4	1.35	16.5	25	5,000	xx	± 0.6 <sup>(1)</sup>	R417 3xx 110
Available attenuation value: xx = 03, 06, 10, 20 and 30 dB							
4	1.35	16.5	30	5,000	xx	± 0.6 <sup>(1)</sup>	R417 3xx 130
Available attenuation value: xx = 03, 06, 10, 20 and 30 dB							
8	1.25	19.1	15 <sup>(2)</sup>	250	xx	± 0.3	R415 7xx 000
Available attenuation value: xx = 03, 06, 10 and 20 dB							
18	1.4	15.6	15 <sup>(2)</sup>	300	xx	± 0.5	R416 0xx 000
Available attenuation value: xx = 03, 06, 10 and 20 dB							

<sup>(1)</sup> up to xx = 10

<sup>(2)</sup> 12 for xx= 06 , 10 for xx = 10 and 20

### SMA - 50 OHMS, MALE TO FEMALE

Frequency DC to (GHz)	VSWR max.	Return loss min. (dB)	Power rating (W)		Nom. Attenuation (dB)	Max dev.	Part number
			Avg. (W)	Peak (W)			
4	1.35	16.5	25	5,000	xx	± 0.6 <sup>(1)</sup>	R417 5xx 110
Available attenuation value: xx = 03, 06, 10, 20 and 30 dB							
4	1.35	16.5	30	5,000	xx	± 0.6 <sup>(1)</sup>	R417 5xx 130
Available attenuation value: xx = 03, 06, 10, 20 and 30 dB							
8	1.25	19.1	15 <sup>(2)</sup>	250	xx	± 0.3	R415 3xx 000
Available attenuation value: xx = 03, 06, 10 and 20 dB							
18	1.4	15.6	15 <sup>(2)</sup>	300	xx	± 0.5	R416 1xx 000
Available attenuation value: xx = 03, 06, 10 and 20 dB							

<sup>(1)</sup> up to xx = 10

<sup>(2)</sup> 12 for xx= 06 , 10 for xx = 10 and 20

### TNC - 50 OHMS, MALE TO FEMALE

Frequency DC to (GHz)	VSWR max.	Return loss min. (dB)	Power rating (W)		Nom. Attenuation (dB)	Max dev.	Part number
			Avg. (W)	Peak (W)			
4	1.35	16.5	25	5,000	xx	± 0.6 <sup>(1)</sup>	R417 6xx 110
Available attenuation value: xx = 03, 06, 10, 20 and 30 dB							
4	1.35	16.5	30	5,000	xx	± 0.6 <sup>(1)</sup>	R417 6xx 130
Available attenuation value: xx = 03, 06, 10, 20 and 30 dB							
8	1.25	19.1	15 <sup>(2)</sup>	250	xx	± 0.3 <sup>(1)</sup>	R415 5xx 000
Available attenuation value: xx = 03, 06, 10 and 20 dB							
18	1.4	15.6	15 <sup>(2)</sup>	300	xx	± 0.5	R416 8xx 000
Available attenuation value: xx = 03, 06, 10 and 20 dB							

<sup>(1)</sup> up to xx = 10

<sup>(2)</sup> 12 for xx= 06 , 10 for xx = 10 and 20





High Power Attenuators, up to 100 Watts

**7/16 - 50 OHMS, MALE TO FEMALE**

Frequency DC to (GHz)	VSWR max.	Return loss min. (dB)	Power rating (W)		Nom. Attenuation (dB)	Max dev.	Part number
			Avg. (W)	Peak (W)			
3	1.35	16.5	50	5,000	xx	± 0.7 <sup>(1)</sup>	R420 0xx 110
Available attenuation value: xx = 03, 06, 10 and 20 dB							
3	1.3	17.7	100	5,000	xx	± 1 <sup>(1)</sup>	R420 7xx 110
Available attenuation value: xx = 03, 06, 10 and 20 dB							

<sup>(1)</sup> up to xx = 10

**N - 50 OHMS, MALE TO FEMALE**

Frequency DC to (GHz)	VSWR max.	Return loss min. (dB)	Power rating (W)		Nom. Attenuation (dB)	Max dev.	Part number
			Avg. (W)	Peak (W)			
3	1.35	16.5	50	5,000	xx	± 0.7 <sup>(1)</sup>	R417 0xx 110
Available attenuation value: xx = 03, 06, 10, 20 and 30 dB							
2	1.25	19.1	100	5,000	xx	± 1	R417 7xx 118
Available attenuation value: xx = 03, 06, 10 and 20 dB							

<sup>(1)</sup> up to xx = 10

**N - 50 OHMS, MALE TO FEMALE, CONDUCTION AND CONVECTION COOLING**

Frequency DC to (GHz)	VSWR max.	Return loss min. (dB)	Power rating (W)		Nom. Attenuation (dB)	Max dev.	Part number
			Avg. (W)	Peak (W)			
3	1.35	16.5	40 / 50	5,000	xx	± 0.7 <sup>(1)</sup>	R417 0xx 120
Available attenuation value: xx = 03, 06, 10, 20 and 30 dB							
2	1.25	19.1	80 / 100	5,000	xx	± 1	R417 7xx 128
Available attenuation value: xx = 03, 06, 10 and 20 dB							

<sup>(1)</sup> up to xx = 10

**N - 50 OHMS, MALE TO FEMALE, CONDUCTION COOLING**

Frequency DC to (GHz)	VSWR max.	Return loss min. (dB)	Power rating (W)		Nom. Attenuation (dB)	Max dev.	Part number
			Avg. (W)	Peak (W)			
3	1.35	16.5	50	5,000	xx	± 0.7 <sup>(1)</sup>	R417 0xx 130
Available attenuation value: xx = 03, 06, 10, 20 and 30 dB							
2	1.25	19.1	100	5,000	xx	± 1	R417 7xx 138
Available attenuation value: xx = 03, 06, 10 and 20 dB							

<sup>(1)</sup> up to xx = 10

**SMA - 50 OHMS, MALE TO FEMALE**

Frequency DC to (GHz)	VSWR max.	Return loss min. (dB)	Power rating (W)		Nom. Attenuation (dB)	Max dev.	Part number
			Avg. (W)	Peak (W)			
3	1.35	16.5	50	5,000	xx	± 0.7 <sup>(1)</sup>	R417 1xx 110
Available attenuation value: xx = 03, 06, 10, 20 and 30 dB							
2	1.25	19.1	100	5,000	xx	± 1	R417 8xx 118
Available attenuation value: xx = 03, 06, 10 and 20 dB							

<sup>(1)</sup> up to xx = 10

**SMA - 50 OHMS, MALE TO FEMALE, CONDUCTION AND CONVECTION COOLING**

Frequency DC to (GHz)	VSWR max.	Return loss min. (dB)	Power rating (W)		Nom. Attenuation (dB)	Max dev.	Part number
			Avg. (W)	Peak (W)			
3	1.35	16.5	50	5,000	xx	± 0.7 <sup>(1)</sup>	R417 1xx 120
Available attenuation value: xx = 03, 06, 10, 20 and 30 dB							
2	1.25	19.1	100	5,000	xx	± 1	R417 8xx 128
Available attenuation value: xx = 03, 06, 10 and 20 dB							



## High Power Attenuators, up to 100 Watts

### SMA - 50 OHMS, MALE TO FEMALE, CONDUCTION COOLING

Frequency DC to (GHz)	VSWR max.	Return loss min. (dB)	Power rating (W)		Nom. Attenuation (dB)	Max dev.	Part number
			Avg. (W)	Peak (W)			
3	1.35	16.5	50	5,000	xx	± 0.7 <sup>(1)</sup>	R417 1xx 130
Available attenuation value: xx = 03, 06, 10, 20 and 30 dB							
2	1.25	19.1	100	5,000	xx	± 1	R417 8xx 138
Available attenuation value: xx = 03, 06, 10 and 20 dB							

<sup>(1)</sup> up to xx = 10

### TNC - 50 OHMS, MALE TO FEMALE

Frequency DC to (GHz)	VSWR max.	Return loss min. (dB)	Power rating (W)		Nom. Attenuation (dB)	Max dev.	Part number
			Avg. (W)	Peak (W)			
3	1.35	16.5	50	5,000	xx	± 0.7 <sup>(1)</sup>	R417 2xx 110
Available attenuation value: xx = 03, 06, 10, 20 and 30 dB							
2	1.25	19.1	100	5,000	xx	± 1	R417 9xx 118
Available attenuation value: xx = 03, 06, 10 and 20 dB							

<sup>(1)</sup> up to xx = 10

### TNC - 50 OHMS, MALE TO FEMALE, CONDUCTION AND CONVECTION COOLING

Frequency DC to (GHz)	VSWR max.	Return loss min. (dB)	Power rating (W)		Nom. Attenuation (dB)	Max dev.	Part number
			Avg. (W)	Peak (W)			
3	1.35	16.5	50	5,000	xx	± 0.7 <sup>(1)</sup>	R417 2xx 120
Available attenuation value: xx = 03, 06, 10, 20 and 30 dB							
2	1.25	19.1	100	5,000	xx	± 1	R417 9xx 128
Available attenuation value: xx = 03, 06, 10 and 20 dB							

<sup>(1)</sup> up to xx = 10

### TNC - 50 OHMS, MALE TO FEMALE, CONDUCTION COOLING

Frequency DC to (GHz)	VSWR max.	Return loss min. (dB)	Power rating (W)		Nom. Attenuation (dB)	Max dev.	Part number
			Avg. (W)	Peak (W)			
3	1.35	16.5	50	5,000	xx	± 0.7 <sup>(1)</sup>	R417 2xx 130
Available attenuation value: xx = 03, 06, 10, 20 and 30 dB							
2	1.25	19.1	100	5,000	xx	± 1	R417 9xx 138
Available attenuation value: xx = 03, 06, 10 and 20 dB							

<sup>(1)</sup> up to xx = 10



**Platinum Attenuators, up to 2 Watts**

Radiall's platinum series of attenuators are designed for Test & Measurement applications. This range can be easily integrated in communication matrices, test benches and laboratories where high RF performance and reliability are essential.

**Here are the main features of Radiall's platinum series of terminations:**

- 2W power rating
- Frequency from DC up to 40 GHz
- 50Ω Impedance
- Attenuation value from 0 to 30 dB
- Lowest VSWR for test applications
- Compatible with all standard Test & Measurement interfaces
- Connector interface according to applicable MIL, DIN, NF and CEI
- Full integration in Radiall Test & Measurement offer: Electro-mechanical switches and TestPro cable Assemblies



**SMA2.9 - 50 OHMS, MALE TO FEMALE**

Frequency DC to (GHz)	VSWR max.	Return loss min. (dB)	Power rating (W)	Impedance Ω	Nom. Attenuation	Max dev.	Part number
40	1.45	14.71907141	2	50	xx	±0.5 dB	R413 3xx 150
Available attenuation value: xx = 03, 06, 10, 20, 30 dB							

**SMA3.5 - 50 OHMS, MALE TO FEMALE**

Frequency DC to (GHz)	VSWR max.	Return loss min. (dB)	Power rating (W)	Impedance Ω	Nom. Attenuation	Max dev.	Part number
26.5	1.35	16.53999636	2	50	xx	±0.4 dB	R413 2xx 150
Available attenuation value: xx = 03, 06, 10, 20, 30 dB							

**SMA - 50 OHMS, MALE TO FEMALE**

Frequency DC to (GHz)	VSWR max.	Return loss min. (dB)	Power rating (W)	Impedance Ω	Nom. Attenuation	Max dev.	Part number
18	1.3	17.69213163	2	50	xx	±0.4 dB	R413 8xx 150
Available attenuation value: xx = 03, 06, 10, 20, 30 dB							

**N - 50 OHMS, MALE TO FEMALE**

Frequency DC to (GHz)	VSWR max.	Return loss min. (dB)	Power rating (W)	Impedance Ω	Nom. Attenuation	Max dev.	Part number
18	1.12	24.9430923	2	50	xx	±0.4 dB	R414 7xx 150
Available attenuation value: xx = 03, 06, 10, 20, 30 dB							

**TNC - 50 OHMS, MALE TO FEMALE**

Frequency DC to (GHz)	VSWR max.	Return loss min. (dB)	Power rating (W)	Impedance Ω	Nom. Attenuation	Max dev.	Part number
12.4	1.1	26.44438589	2	50	xx	±0.4 dB	R414 5xx 150
Available attenuation value: xx = 03, 06, 10, 20, 30 dB							

**BNC - 50 OHMS, MALE TO FEMALE**

Frequency DC to (GHz)	VSWR max.	Return loss min. (dB)	Power rating (W)	Impedance Ω	Nom. Attenuation	Max dev.	Part number
4	1.1	26.44438589	2	50	xx	±0.4 dB	R414 4xx 150
Available attenuation value: xx = 03, 06, 10, 20, 30 dB							



## Introduction

### COAXIAL COUPLERS

3dB hybrid couplers and directional couplers are passive devices used in the microwave field. A directional coupler is a reciprocal 4 port device. When a signal is applied to its input port, it provides 2 amplitude ports, coupling is the ratio in dB of the incident power fed into the input port of the main line of the directional coupler to the coupled port of the secondary line when all ports are terminated on matched load. A 3db Hybrid coupler is a special class of directional couplers in which signals at the two outputs are equal to split RF signal in 2 equal parts or to combine 2 RF signals on one port.

Directional couplers and power dividers have many applications, these include; providing a signal sample for measurement or monitoring, feedback, combining feeds to and from antennas, antenna beam forming.

### SPECIAL DEVICES

#### Feed through terminations

These components are used to properly terminate a transmission line while testing with a high impedance measuring system such as an oscilloscope input.

#### Detectors

A detector is a 2 port device capable of supplying a low frequency signal on its output port (video), of a level proportional of the RF power applied to its input port. This proportionality is achieved by means of non linearity property of the diodes used which at low level supply a detected voltage proportional to the RF voltage.

#### Rotary joints

These components provide the transition between two coaxial transmission lines rotating with respect to each other while retaining acceptable RF characteristics.

#### DC blocks

DC blocks are composed of a capacitor inserted to the central conductor of the coaxial line. They block any DC or low frequency current present on the line.

#### Signal samplers

These devices are used to sample part of an RF signal from a coaxial line. They are not directive, and sample incident and reflected energy.

#### Phase shifters

These components create a mechanically adjustable phase shift by variation in the physical length of the transmission line.



Couplers

**3 dB 90° HYBRID COUPLERS**

Frequency (GHz)	Amplitude balance (dB)	Phase balance	Input power (W)		Max insertion loss (dB) Attenuation (dB)	Min isolation (dB)	VSWR max.	Connectors main / coupled	Part number
			Ave. <sup>(1)</sup>	Peak <sup>(2)</sup>					
0.15 - 0.3	± 0.5	90° ± 0.5°	500	5,000	0.3	30	1.15	N f / N f	R432 171 000
0,25 - 0.5	± 0.5	90° ± 5°	500	5,000	0.3	30	1.15	N f / N f	R432 271 000
0.5 - 1	± 0.5	90° ± 5°	300	5,000	0.3	25	1.15	N f / N f	R432 371 000
1 - 2	± 0.5	90° ± 5°	100	3,000	0.3	25	1.2	SMA f / SMA f	R432 431 000
1 - 2	± 0.5	90° ± 5°	200	5,000	0.3	25	1.2	N f / N f	R432 471 000
2 - 4	± 0.5	90° ± 5°	80	3,000	0.3	23	1.2	SMA f / SMA f	R432 531 000
2 - 4	± 0.5	90° ± 5°	80	3,000	0.3	20	1.2	N f / N f	R432 571 000
4 - 8	± 0.5	90° ± 5°	50	3,000	0.3	19	1.25	SMA f / SMA f	R432 631 000
7 - 12,4	± 0.5	90° ± 6°	30	3,000	0.4	18	1.35	SMA f / SMA f	R433 721 700
6 - 18	± 0.6	90° ± 6°	30	3,000	0.6	15	1.5	SMA f / SMA f	R433 611 700
12,4 - 18	± 0.7	90° ± 6°	30	3,000	0.6	16	1.4	SMA f / SMA f	R433 831 700

<sup>(1)</sup> at 25°C

<sup>(2)</sup> at 25°C (1us - duty cycle 1%)

**DIRECTIONAL COUPLERS**

(all directional couplers are loaded with SMA 50 Ohms termination)

Frequency (GHz)	Amplitude balance (dB)	Phase balance	Input power (W)		Max insertion loss <sup>(3)</sup> (dB) Attenuation (dB)	Directivity (dB)	VSWR max. <sup>(4)</sup>	Connectors main / coupled	Part number
			Ave. <sup>(1)</sup>	Peak <sup>(2)</sup>					
0.15 - 0.3	6 ± 0.3	± 0.8	500	5,000	2	30	1.10 / 1.10	N f / N f	R432 172 000
0.15 - 0.3	10 ± 0.3	± 0.8	500	5,000	1	30	1.10 / 1.10	N f / N f	R432 173 000
0.15 - 0.3	20 ± 0.3	± 0.8	500	5,000	0.4	30	1.10 / 1.10	N f / N f	R432 174 000
0.15 - 0.3	30 ± 0.3	± 0.8	500	5,000	0.4	30	1.10 / 1.10	N f / N f	R432 175 000
0.25 - 0.5	10 ± 0.3	± 0.8	500	5,000	1	30	1.12 / 1.12	N f / N f	R432 273 000
0.25 - 0.5	20 ± 0.3	± 0.8	500	5,000	0.4	30	1.12 / 1.12	N f / N f	R432 274 000
0.25 - 0.5	30 ± 0.3	± 0.8	500	5,000	0.4	30	1.12 / 1.12	N f / N f	R432 275 000
0.5 - 1	6 ± 0.3	± 0.8	300	5,000	2	25	1.15 / 1.15	N f / N f	R432 372 000
0.5 - 1	10 ± 0.3	± 0.8	300	5,000	1	27	1.15 / 1.15	N f / N f	R432 373 000
0.5 - 1	20 ± 0.3	± 0.8	300	5,000	0.4	27	1.15 / 1.15	N f / N f	R432 374 000
0.5 - 1	30 ± 0.3	± 0.8	300	5,000	0.4	27	1.15 / 1.15	N f / N f	R432 375 000
1 - 2	6 ± 1.1	± 0.8	100	3,000	1.8	23	1.20 / 1.20	SMA f / SMA f	R432 432 000
1 - 2	10 ± 0.3	± 0.8	100	3,000	1	23	1.15 / 1.15	SMA f / SMA f	R432 433 000
1 - 2	20 ± 0.3	± 0.8	100	3,000	0.4	23	1.15 / 1.15	SMA f / SMA f	R432 434 000
1 - 2	30 ± 0.3	± 0.8	100	3,000	0.4	23	1.15 / 1.15	SMA f / SMA f	R432 435 000
1 - 2	6 ± 0.3	± 0.6	200	5,000	2.25	23	1.15 / 1.15	N f / N f	R432 472 000
1 - 2	10 ± 0.3	± 0.8	200	5,000	1	23	1.15 / 1.15	N f / N f	R432 473 000
1 - 2	20 ± 0.3	± 0.8	200	5,000	0.4	23	1.15 / 1.15	N f / N f	R432 474 000
1 - 2	30 ± 1.1	± 0.8	200	5,000	0.4	23	1.15 / 1.15	N f / N f	R432 475 000
2 - 4	10 ± 0.3	± 0.8	80	3,000	1	20	1.15 / 1.15	SMA f / SMA f	R432 533 000



Couplers

Frequency (GHz)	Amplitude balance (dB)	Phase balance	Input power (W)		Max insertion loss <sup>(3)</sup> (dB) Attenuation (dB)	Directivity (dB)	VSWR max. <sup>(4)</sup>	Connectors main / coupled	Part number
			Ave. <sup>(1)</sup>	Peak <sup>(2)</sup>					
2 - 4	10 ± 0.3	± 0.8	100	3,000	0.4	20	1.15 / 1.15	N f / N f	R432 573 000
2 - 4	20 ± 0.3	± 0.8	80	3,000	0.4	20	1.15 / 1.15	SMA f / SMA f	R432 534 000
2 - 4	20 ± 0.3	± 0.8	100	3,000	0.4	20	1.15 / 1.15	N f / N f	R432 574 000
2 - 4	30 ± 1.1	± 0.8	80	3,000	0.4	20	1.15 / 1.15	SMA f / SMA f	R432 535 000
4 - 8	10 ± 0.3	± 0.8	50	3,000	1	17	1.20 / 1.20	SMA f / SMA f	R432 633 000
4 - 8	20 ± 0.3	± 0.8	50	3,000	0.4	17	1.20 / 1.20	SMA f / SMA f	R432 634 000
4 - 8	30 ± 0.3	± 0.8	50	3,000	0.4	17	1.20 / 1.20	SMA f / SMA f	R432 635 000

<sup>(1)</sup> at 25°C  
<sup>(2)</sup> at 25°C (1us - duty cycle 1%)  
<sup>(3)</sup> coupling loss included  
<sup>(4)</sup> main line / coupled line

**FLAT FREQUENCY RESPONSE DIRECTIONAL COUPLERS**  
 (all directional couplers are loaded with SMA 50 Ohms termination)

Frequency (GHz)	Coupling <sup>(4)</sup> (dB)	Frequency sensitivity <sup>(4)</sup> ± (dB)	Input power(W)		Max insertion loss <sup>(5)</sup> (dB) Attenuation (dB)	Directivity (dB)	VSWR max. <sup>(3)</sup>	Connectors main / coupled	Part number
			Ave. <sup>(1)</sup>	Peak <sup>(2)</sup>					
0.9 - 2.1	10 ± 0.8	± 0.3	50	3,000	1	22	1.15 / 1.15	SMA f / SMA f	R433 423 000
0.9 - 2.1	10 ± 0.5	± 0.3	50	3,000	1	22	1.20 / 1.20	N f / N f	R433 463 000
0.9 - 2.1	20 ± 0.8	± 0.3	50	3,000	0.4	22	1.15 / 1.15	SMA f / SMA f	R433 424 000
0.9 - 2.1	20 ± 0.5	± 0.3	50	3,000	0.4	22	1.20 / 1.20	N f / N f	R433 464 000
1.7 - 4.2	10 ± 0.8	± 0.3	50	3,000	1	20	1.20 / 1.20	SMA f / SMA f	R433 523 000
1.7 - 4.2	10 ± 0.5	± 0.3	50	3,000	1	20	1.25 / 1.25	N f / N f	R433 563 000
1.7 - 4.2	20 ± 0.8	± 0.3	50	3,000	0.4	20	1.20 / 1.20	SMA f / SMA f	R433 524 000
1.7 - 4.2	20 ± 0.8	± 0.4	50	3,000	0.4	20	1.25 / 1.25	N f / N f	R433 564 000
3.7 - 8.3	10 ± 0.5	± 0.3	50	3,000	1	18	1.25 / 1.25	SMA f / SMA f	R433 623 000
3.7 - 8.3	10 ± 0.5	± 0.3	50	3,000	1	18	1.30 / 1.30	N f / N f	R433 663 000
3.7 - 8.3	20 ± 0.5	± 0.3	50	3,000	0.4	18	1.25 / 1.25	SMA f / SMA f	R433 624 000
3.7 - 8.3	20 ± 0.5	± 0.3	50	3,000	0.4	18	1.30 / 1.30	N f / N f	R433 664 000
2 - 8	10 ± 1	± 0.4	50	3,000	1	20	1.25 / 1.25	SMA f / SMA f	R433 513 700
2 - 8	20 ± 1	± 0.4	50	3,000	0.4	20	1.25 / 1.25	SMA f / SMA f	R433 514 700
7 - 12.4	10 ± 1	± 0.5	50	3,000	1	16	1.30 / 1.30	SMA f / SMA f	R433 723 700
7 - 12.4	20 ± 1	± 0.5	50	3,000	0.4	16	1.30 / 1.30	SMA f / SMA f	R433 724 700
2 - 18	10 ± 1	± 0.6	20	3,000	1.4	12	1.35 / 1.50	SMA f / SMA f	R433 503 000
6 - 18	6 ± 1	± 0.5	50	3,000	2.2	15	1.40 / 1.40	SMA f / SMA f	R433 612 700
6 - 18	10 ± 1	± 0.5	50	3,000	1.1	16	1.40 / 1.40	SMA f / SMA f	R433 613 700
6 - 18	20 ± 1	± 0.5	50	3,000	0.6	15	1.40 / 1.40	SMA f / SMA f	R433 614 700
12.4 - 18	6 ± 1	± 0.5	50	3,000	2.2	15	1.40 / 1.40	SMA f / SMA f	R433 832 700
12.4 - 18	10 ± 1	± 0.5	50	3,000	1.1	15	1.35 / 1.35	SMA f / SMA f	R433 833 700
12.4 - 18	20 ± 1	± 0.5	50	3,000	0.55	15	1.35 / 1.35	SMA f / SMA f	R433 834 700

<sup>(1)</sup> at 25°C  
<sup>(2)</sup> at 25°C (1us - duty cycle 1%)  
<sup>(3)</sup> main line / coupled line  
<sup>(4)</sup> frequency sensitivity is included in coupling  
<sup>(5)</sup> coupling loss included



Special Devices

**FEED THROUGH TERMINATION BNC - 50 AND 75 OHMS**

Frequency DC to (GHz)	VSWR max.	Return loss min. (dB)	Power		VSWR max.	Connectors main / coupled	Part number
			Ave.(W)	Peak(W)			
1	1.35	16.5	2	1,000	50±5%	m / f straight	R405 005 000
1	1.35	16.5	2	1,000	50±5%	m / f right angle	R405 035 000
1	1.35	16.5	2	1,000	75±5%	m / f straight	R405 006 000

**WIDE BAND DETECTORS (all detectors use Schottky zero bias diode - they are 50 Ohms -12dBm. CW = 200 mw, peak power 2 W)**

Frequency (GHz)	Connectors		Part number	
	Input HF	Output video	Negative	Positive
0.01 - 18	SMA m	SMB m	R451 533 000	R451 533 500
0.01 - 18	SMA m	SMC m	R451 534 000	R451 534 500
0.01 - 18	SMA m	SMA f	R451 542 000	R451 542 500
0.01 - 18	SMA m	pin	R451 543 000	R451 543 500
0.01 - 18	SMA m	BNC f	R451 544 000	R451 544 500
0.01 - 12.4	N m	BNC f	R451 574 000	R451 574 500
0.01 - 18	N m	BNC f	R451 576 000	R451 576 500
2.45	N m	BNC f	R451 572 120	

**HIGH SENSIBILITY DETECTORS (all detectors use Schottky zero bias diode - they are 50 Ohms -12dBm. CW = 200 mw, peak power 2 W)**

Frequency (GHz)	Connectors		Part number	
	Input HF	Output video	Negative	Positive
1 - 18	SMA m	SMB m	R451 030 000	R451 030 500
1 - 18	SMA m	SMC m	R451 031 000	R451 031 500
1 - 18	SMA m	SMA f	R451 032 000	R451 032 500
1 - 18	SMA m	Pin	R451 033 000	R451 033 500
1 - 18	SMA m	BNC f	R451 034 000	R451 034 500

**DIODE HOLDER DETECTORS**

Frequency (GHz)	Connectors		Part number	
	Input HF	Output video	Negative	Positive
0.01 - 4	N m	BNC f	R451 570 000	R451 570 500
0.01 - 10	N m	BNC f	R451 075 000	

**ROTARY JOINTS**

Frequency DC to (GHz)	VSWR max.	Max V.S.W.R. variation per turn	Insertion loss (dB) max.	Power max	Part number
18	1.5	1.02	0.60	50	R447 120 000
18	1.5	1.02	0.80	40	R447 171 000

COUPLERS & SPECIAL DEVICES



Special Devices

**DC BLOCKS: INNER CONDUCTOR BLOCK TYPE**

Frequency (GHz)	Capacitance (pF)	VSWR max.	Insertion loss (dB) max.	Connectors	Main line max DC voltage (Volts)	Part number
0.01 - 6	4700	1.30	0.50	SMA m/f	63	R443 131 000
1 - 12.4	100	1.25	0.50	SMA m/f	300	R443 134 000
0.01 - 6	4700	1.30	0.50	BNC m/f	63	R443 141 000
0.01 - 6	4700	1.30	0.50	TNC m/f	63	R443 151 000
0.01 - 6	4700	1.30	0.50	N m/f	63	R443 171 000
0.01 - 6	4700	1.30	0.50	QMA m/f	63	R443 191 000
0.5 - 22	180	1.25	0.50	SMA m/f	100	R443 137 000
0.1 - 40	180	1.35	0.60	SMA2.9	100	R443 162 000

**MONITOR TEES**

Frequency (GHz)	Nominal capacity (pF)	VSWR max.	Insertion loss (dB) Max.	Max average power (W)	Connectors	Part number
0.01 - 1.5	15000	1.30	0.25	50	SMA	R443 530 000
0.9 - 3	10	1.25	0.25	10	SMA	R443 533 480
1.5 - 6	10	1.20	0.40	40	SMA	R443 533 000
6 - 12.4	3.5	1.35	0.50	40	SMA	R443 536 000

**SIGNAL SAMPLERS**

Frequency DC to (GHz)	Coupling variation (W)	VSWR max.	Insertion loss (dB) Max.	Connectors main line	Connector coupled line	Part number
12.4	6 / Octave	1.50	0.20	N male/female	BNC	R435 270 000 <sup>(1)</sup>
12.4	6 / Octave	1.50	0.20	N male/female	BNC	R435 170 000 <sup>(2)</sup>
12	6 / Octave	1.50	0.20	N male/female	BNC	R435 470 000 <sup>(3)</sup>

<sup>(1)</sup> Loop probe, <sup>(2)</sup> Resistive loop probe, <sup>(3)</sup> Capacitive probe

**PHASE SHIFTERS**

Frequency DC to (GHz)	Total phase variation	VSWR max.	Connectors	Part number
18	180° [18GHz]	1.30	SMA male / female	R499103000
18	180° [18GHz]	1.30	SMA male to S.R. .141 cable	R499101000



NOTE



SIMPLIFICATION IS OUR INNOVATION

# NOTE





## BANANA PLUGS

R644/R921/R929/R941/R948/R995/R999

**Contents****BANANA PLUGS**

Introduction .....	20-4 to 20-5
Finder guide .....	20-6 to 20-7

**4MM SERIES**

Introduction .....	20-8
Characteristics .....	20-9
Packaging .....	20-9
Safety series - Plugs .....	20-10
- Sockets .....	20-11
- Patch cords .....	20-11 to 20-13
Standard series - Plugs .....	20-14 to 20-15
- Sockets .....	20-15
- Patch cords .....	20-16 to 20-17
Accessories .....	20-18

**2MM SERIES**

Introduction .....	20-19 to 20-20
Characteristics .....	20-21 to 20-22
Packaging .....	20-22
Plugs .....	20-23 / 20-25
Sockets .....	20-24
Patch cords .....	20-24
20 way fixed connectors .....	20-26
Contact blocks .....	20-27
Ribbon patch cords .....	20-28
Accessories .....	20-28

**BANANA ADAPTERS**

Introduction .....	20-29
Characteristics .....	20-29
Packaging .....	20-29
Adapters .....	20-30
Adapters patch cords .....	20-31
Panel drilling .....	20-32

**Introduction**

Radiall offers a wide selection of high quality and reliable professional banana plugs for the most demanding test and measurement applications.

Radiall's professional banana plugs consist of two major series and adapters:

**The 4mm Series**

- Safety plugs and sockets
- Safety patch cords
- Standard plugs and sockets
- Standard patch cords
- Accessories

**The 2mm Series**

- Plugs and sockets
- Patch cords
- PCB test points
- 20-way fixed connector
- Short circuit links
- Contact block and ribbon patch cords
- Accessories

**Adapters**

- 2mm/4mm banana adapter
- BNC/2mm banana adapter
- BNC/4mm banana adapter
- Banana adapter patch cord
- Coaxial banana adapter patch cord



**Applications**

- Research institutes and laboratories
- Education
- Instrumentations
- Low voltage
- Electronics
- Engineering



## Introduction

### FEATURES AND BENEFITS

Radiall's in-house technologies ensure high reliable product solutions due to its expertise and advanced design technology.

Radiall's contacts consists of a monoblock pin fitted with a copper beryllium spring finger. Depending on the model, the pin may or may not have a protective sleeve.

	4mm series	2mm series
Contact resistance	0.5 mΩ	1mΩ
Current rating, max @ 20 °C	30 A	10 A
Contact durability, min.	10,000 mating cycles	

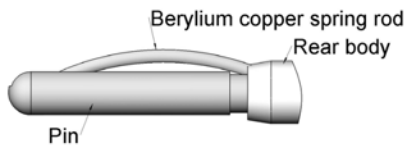

#### Benefits





- Excellent electrical conduction
- Very low contact resistance
- Robust contact point pressure when connected
- High durability for high number of mating cycles

### GLOSSARY OF ABBREVIATIONS

Abbreviation series		Destination
4mm	2mm	
B1	BL-I	Insulated plug with solder connection
B2		Insulated plug with crimp or solder connection
	BL-PI	Insulated panel plug
B4	BL	Uninsulated plug
	BL2-4	Uninsulated threaded plug
	BLP-4	Uninsulated panel plug with solder connection
DPI	DL-PL	Insulated panel socket
DPIS		Insulated safety panel socket
DP	DLP	Uninsulated panel socket
	BLP D-2	Uninsulated panel plug/2mm dia. socket
BDR-4	BDR-2	Stackable plug with quick grip cable clamp
BDR-SR		Stackable plug, partial safety
BDR-PR		Stackable plug, partial safety non thermofusible sleeve
BDM	BLDM	Stackable patch cord
BDSA		Stackable patch cord, total safety
BDSR		Stackable patch cord, partial safety
BM	BLM	Extension patch cord
DM	DLM	Extension female patch cord
PTM		Test probe patch cord
	FL	Contact block
	ML	Ribbon patch cords

4MM/2MM SERIES

Finder Guide

Series	Image	Category	Description	Page
4mm		Banana plugs	Stackable plug (BDR-SR)	11
			Stackable plug, non-thermofusible sleeve (BDR-PR)	
		Panel sockets	Insulated safety panel socket (DPIS)	12
			Plug/Plug stackable, retractable sleeve (BDSA)	
		Patch cords	Plug/Plug stackable, non-retractable sleeve (BDSA)	13
			Patch cords made to order	
		Banana plugs	Uninsulated plug (B4)	14
			Insulated plug with solder connection (B1)	
			Insulated plug with crimp or solder connection (B2)	
			Stackable plug with quick grip cable clamp (BDR-4)	
		Panel sockets	Uninsulated panel sockets (DP)	15
			Insulated panel sockets (DP)	
		Patch cords	BM/BM extension patch cords	16
			BDM/BDM stackable patch cords	
			PTM/BM Test probe patch cords	
			Accessories and Adapter	Test clip - with alligator clip
	Test clip - with flexible steel rod			
Crocodile clip				
Safety test probe				
Safety female - female adapter				
2mm		Banana plugs	Uninsulated plug with crimp or solder connection (BL)	23
			Uninsulated panel plug with solder connection (BLP-4)	
			Uninsulated panel plug/2mm dia. socket (BLP D-2)	
			Insulated plugs with solder connection (BL-I)	
			Insulated panel plug (BL-PI)	
		Stackable plug with quick grip cable clamp (BDR-2)		
	Panel sockets	Uninsulated panel sockets (DLP)	24	
		Insulated panel sockets (DL-PI)		
	Patch cords	BLM extension patch cords	25	
		BLDM stackable patch cords		
Patch cords made to order				

Finder Guide

Series	Image	Category	Description	Page		
2mm		Standard series	Multi-contact 20-way fixed connectors	Solder cup - 12mm contact pitch	26	
				Solder cup - 6mm contact pitch		
				Pin - 12mm contact pitch		
				Pin - 6mm contact pitch		
		Short cut circuit		12mm contact pitch		
				6mm contact pitch		
		Contact blocks		Male contact blocks (FL M)		27
				Female contact blocks (FL F)		
		Patch leads		Male - male ribbon patch cords (ML MM)		28
				Female - female ribbon patch cords (ML FF)		
	Accessories		PCB Test socket	30		
			Test probe			
Adapters		Banana adapters	2mm male - 4mm female	32		
		BNC/Banana adapters	BNC/2mm Banana adapter			
			BNC/4mm Banana adapter			
		Banana adapters patch cords			BLM/BM	33
					BLDM/BDM	
					BLM/DM	
	Coaxial patch cords		BNC/BCX			



## 4 mm Series

**INTRODUCTION****4 MM SAFETY SERIES**

Due to safety being an important criteria when using test and measurement instrumentation, especially for high voltage use, Radiall developed the 4 mm Safety Series, which offers an improved protection system that eliminates all risk of contact with live elements when handling components.

Safety connectors are reinforced by a protective sleeve and an insulation cap on the top of the contact. The protective sleeve may be retractable or non-retractable. All plugs with non-retractable sleeves are rated at 600V, CAT III or 1000V, CAT II according to the safety standard IEC 61010-031 version 2002.

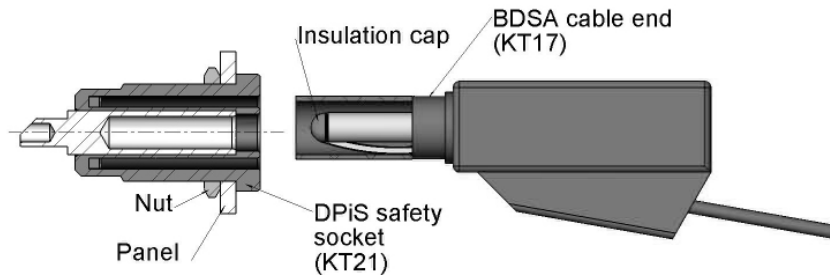
**4 MM STANDARD SERIES**

The 4 mm Standard Series meets the requirements of NF C 93 440 standards. The product in this series are not intended for hand-held use at voltage above 30Vac/60Vdc.

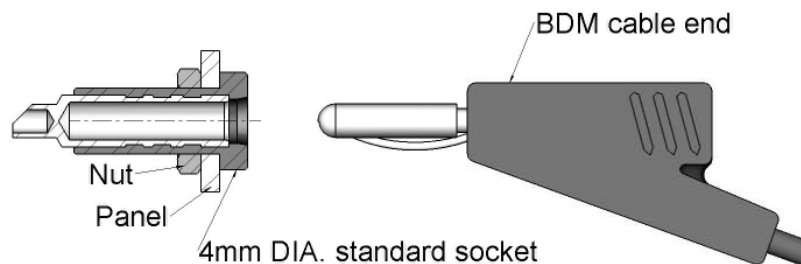

*Example of a regular connection: the contact is exposed.*

**ACCESSORIES: TEST CLIPS**

- With sliding hook: The contact hook guarantees a good grip on wires, components and PCB pin up to 1.5 mm<sup>2</sup> thick.
- Alligator Test Clips: Features a large opening and gripping efficiency for use on motors, fuse holders, terminals, etc.
- Flexible Steel Rod Test Clips: The thin flexible steel rod allows testing of hard-to-reach points in dense circuitry.
- Crocodile Test Clips: Features a large 20 mm opening to allow attachment to larger test points.
- Safety Test Probe: An extra thin probe allows contact through coatings and some insulations. It can also be used for PCB measurements. Fitted with a rear-mounted 4 mm socket, it can be used with BM patch cords.

## 4 mm Series

## CHARACTERISTICS

	PLUGS	SOCKETS	PATCH CORDS
--	-------	---------	-------------

## ELECTRICAL CHARACTERISTICS

Current rating, max. • 4 mm safety • 4 mm standard	30A (@ 20C)	15 A (@ 20C) patch cords 1 mm <sup>2</sup> 15 A (@ 20C) patch cords 1 mm <sup>2</sup> 30 A (@ 20C) 2 an 2.5 mm <sup>2</sup>
Dielectric withstanding voltage	2500 Vrms @ 50Hz	
Operating voltage	750 Vrms @ 50Hz	
Insulation resistance, min.	5000 MΩ	
Contact resistance, max.	0.5mΩ	-

## MECHANICAL CHARACTERISTICS

Mechanical, durability, min.	10,000 matings		
Average insertion force	25N		
Tightening torque • 4 mm safety • 4 mm standard	-	Max 140 N.cm 120 N.cm	-

## ENVIRONMENTAL CHARACTERISTICS

Temperature range • 4 mm safety • 4 mm standard	-40 °C / +85 °C	-40 °C / +100 °C	BDSR patch cords -40 °C / +85 °C BDSA patch cords -25M °C / +70 °C
Damp heat	(uninsulated) -65 °C / +155 °C (insulated models) -60 °C / +100 °C		-40 °C / +70 °C

## MATERIALS

Insulation	Thermoplastic
Contacts	Nickel or tin plated Copper alloy/brass

## CHARACTERISTICS ACCESSORIES

	WITH SLIDING HOOK	WITH ALLIGATOR CLIP	WITH FLEXIBLE STEEL RODS	WITH CROCODILE DIE	SAFETY TEST PROBE
--	-------------------	---------------------	--------------------------	--------------------	-------------------

## ELECTRICAL CHARACTERISTICS

Operating voltage, max.	1000 Vrms				1500 Vrms
Current rating max	4A (@20C)	2.5A	32A	32A	-
Clip opening (max)	1.5mm (max hooking capacity)"			20 mm	

## MATERIALS

Body	Thermoplastic		
Contact	Stainless steel		Steel

## PACKAGING

	2 mm safety series	4 mm standard series
Plugs	10 pieces	100 pieces
Panel sockets	100 pieces	
Patch cords	10 pieces	
Accessories	10 pieces	

## Plugs

## STACKABLE PLUG, PARTIAL SAFETY (BDR-SR)

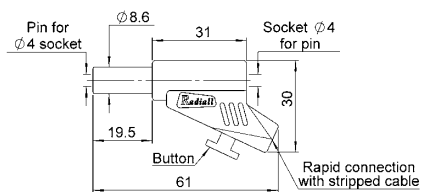

Part number	Color	Standard
R941 460 600	Black	NFC 93440-KT12R
R941 461 600	Red	
R941 462 600	Green	
R941 463 600	Blue	
R941 464 600	Yellow	

## STACKABLE PLUG, PARTIAL SAFETY-NON-THERMOFUSIBLE SLEEVE (BDR-PR)

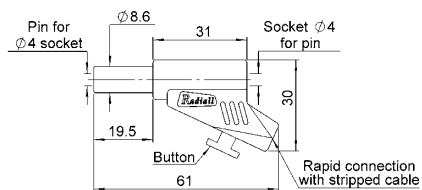

Part number	Color	Standard
R941 480 600	Black	NFC 93440-KT12R DCN 5935 BA
R941 481 600	Red	

Sockets

**INSULATED SAFETY PANEL-MOUNT SOCKETS (DPIS)**

Insulated safety panel sockets are mateable with standard 4mm BM/BDM patch cords and BDSR/BDSA safety patch cords.

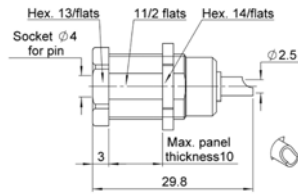

Part number	Color	Termination	Standard	Panel drilling
R941 920 600	Black	Solder cup	NFC 93440-KT21F	P05
R941 921 600	Red			
R941 922 600	Green			
R941 923 600	Blue			
R941 924 600	Yellow			

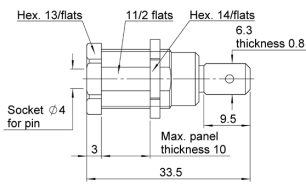

Part number	Color	Termination	Standard	Panel drilling
R941 920 602	Black	Flat for FASTON lug type	NFC 93440-KT21L	P05
R941 921 602	Red			

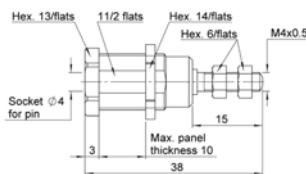

Part number	Color	Termination	Standard	Panel drilling
R941 920 603	Black	For fork lug	NFC 93440-KT21V	P05
R941 921 603	Red			
R941 924 603	Yellow			

Patch Cords

Except where specified, all patch cords lengths are defined by the length of the cable without connectors or strain relief.

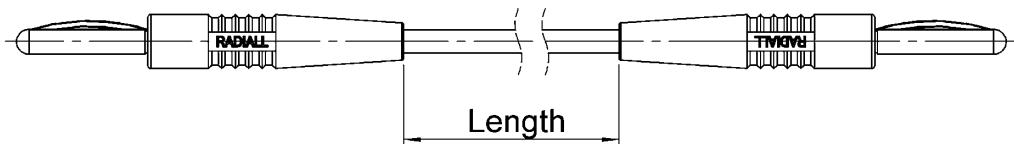

Radiall Patch Cord Series includes:

- **BDSR/BDSR:** Retractable sleeve for partial security
- **BDSA/BDSA:** Non-retractable sleeve where secure connections are critical. The cable assembly is rated at 1000V, CAT II according to the safety standard IEC61010-31
- **Patch cords made-to-order**

Patch Cords

**PLUG/PLUG STACKABLE PATCH CORDS - RETRACTABLE SLEEVE (BDSR/BDSR)**

Cable type:

- PVC, 1mm<sup>2</sup> conductor, 3.5mm insulation
- PVC, 2mm<sup>2</sup> conductor, 3.5mm insulation
- Silicone, 2.5mm<sup>2</sup> conductor, 4mm insulation



**R948 1xx 6xx**

PATCH CORDS LENGTH:

- 3:** 25cm
- 4:** 50cm
- 5:** 100cm
- 6:** 150cm
- 7:** 200cm

COLOR:

- 0:** Black
- 1:** Red

CABLE TYPE:

- 00:** PVC 1mm<sup>2</sup> 3.5mm
- 02:** PVC 2mm<sup>2</sup> 3.5mm
- 29:** Silicone 2.5mm<sup>2</sup> 4mm

**PLUG/PLUG STACKABLE PATCH CORDS - NON-RETRACTABLE SLEEVE (BDSA/BDSA)**

Cable type:

- PVC, 1mm<sup>2</sup> conductor, 3.5mm insulation
- PVC, 2mm<sup>2</sup> conductor, 3.5mm insulation
- Silicone, 2.5mm<sup>2</sup> conductor, 4mm insulation



**R948 3xx 6xx**

PATCH CORDS LENGTH:

- 3:** 25cm
- 4:** 50cm
- 5:** 100cm
- 6:** 150cm
- 7:** 200cm

COLOR:

- 0:** Black
- 1:** Red

CABLE TYPE:

- 00:** PVC 1mm<sup>2</sup> 3.5mm
- 02:** PVC 2mm<sup>2</sup> 3.5mm
- 29:** Silicone 2.5mm<sup>2</sup> 4mm

Patch Cords

**MADE-TO-ORDER PATCH CORDS**

Customized patch cords using BDSR plugs can be made-to-order to meet your specifications. Choices include connector style, cable type, color, and cable length.

**HOW TO ORDER**

	CONNECTOR 1	CABLE TYPE	LENGTH	CONNECTOR 2
<b>BDSR type</b> R949 100 600 / Black R949 101 600 / Red				
<b>PVC, 1mm<sup>2</sup></b> C290 110 / Black C290 111 / Red <b>SILICONE, 1mm<sup>2</sup></b> C290 010 / Black C290 011 / Red				
<b>XXX:</b> cable length in cm				
<b>BDSR type</b> R949 100 600 / Black R949 101 600 / Red				

**EXAMPLE TO ORDER:**

1 black BDSR plug / red silicone 1 mm<sup>2</sup> cable length 125cm / 1 Red BDSR plug.  
 Part number: R949 100 600 / C290 011-125cm / R949 100 600

**NOTE:**

(1) For other options, please contact your local representative

(2) Refer to the table below to select your insert class:

## Plugs

## UNINSULATED BANANA PLUGS

Figure	Part number	Description	Panel drilling
	R941 019 000	Solder or crimp 15mm solder post Strip length: 5mm Crimp tool: Buchanan R612 548 000 Positioner Radiall R282 561 000 Crimp setting: 1.20 (18 AWG) 1.08 (22 AWG) Maxi 15A	-
	R941 029 000	Solder or crimp 2mm solder post Strip length: 5mm Crimp tool: Buchanan R612 548 000 Positioner Radiall R282 561 000 Crimp setting: 1.50 (14 AWG) 1.25 (18 AWG)	-
	R941 049 000	Threaded panel connection 8mm rear length	P03
	R941 069 000	Threaded panel connection 18mm rear length	P03
	R941 149 000	Panel banana plug 4mm with rear socket for mating with 4mm plug	P01

## Plugs

## INSULATED BANANA PLUGS

Figure	Part number	Color	Description
	R941 330 000	Black	Tin-plated solder cup or Rear socket for 2mm banana plug  (14 AWG)
	R941 331 000	Red	
	R941 332 000	Green	
	R941 333 000	Blue	
	R941 334 000	Yellow	
	R941 336 000	White	
	R941 340 000	Black	Tin-plated solder cup or Screw tightening or Rear socket for 2mm banana plug  (14 AWG)
	R941 341 000	Red	
	R941 342 000	Green	
	R941 343 000	Blue	
	R941 344 000	Yellow	
	R941 346 000	White	
	R941 460 000	Black	Stackable banana with quick-grip clamp for stripped cable 2 & 4mm socket for banana plugs
	R941 461 000	Red	

## Sockets

## UNINSULATED PANEL SOCKETS (DP)

Figure	Part number	Description	Panel drilling
	R941 619 000	Solder cup Cup tripping dimension 4mm	P01
	R941 629 000 (nickel plated version)	(14 AWG)	

## INSULATED PANEL SOCKETS (DPI)

Figure	Part number	Color	Description	Panel drilling
	R941 920 001	Black	Tin-plated solder cup UL 94V-0 thermoplastic insulation	P06
	R941 921 001	Red		
	R941 922 001	Green		
	R941 923 001	Blue		
	R941 924 001	Yellow		
	R941 926 001	White		



**Patch Cords**

Except where specified, all patch cords lengths are defined by the length of the cable without connectors or strain relief.

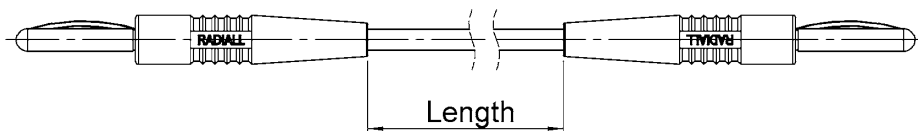

Radiall Patch Cord Series includes:

- **BM/BM:** Molded extension patch cords
- **BDM/BDM:** Molded stackable patch cords
- **PTM/BM:** Molded test probe patch cords
- **Patch cords made-to-order**

**EXTENSION PATCH CORDS (BM/BM)**

Cable type: PVC, 1mm<sup>2</sup> conductor, 3.5mm insulation

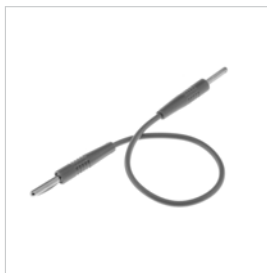

**R948 0xx 000**

PATCH CORDS LENGTH:	
<b>0:</b>	20cm
<b>4:</b>	50cm
<b>5:</b>	100cm
<b>6:</b>	150cm
<b>7:</b>	200cm

COLOR:	
<b>0:</b>	Black
<b>1:</b>	Red
<b>2:</b>	Green
<b>3:</b>	Blue

**STACKABLE PATCH CORDS (BDM/BDM)**

Cable type:

- PVC, 1mm<sup>2</sup> conductor, 3.5mm insulation
- PVC, 2mm<sup>2</sup> conductor, insulation
- Silicone, 2.5mm<sup>2</sup> conductor, 4mm insulation



**R948 1xx 0xx**

PATCH CORDS LENGTH:	
<b>3:</b>	25cm
<b>4:</b>	50cm
<b>5:</b>	100cm
<b>6:</b>	150cm
<b>7:</b>	200cm

COLOR:	
<b>0:</b>	Black
<b>1:</b>	Red
<b>2:</b>	Green
<b>3:</b>	Blue
<b>4:</b>	Yellow

CABLE TYPE:	
<b>00:</b>	PVC 1mm <sup>2</sup> 3.5mm
<b>02:</b>	PVC 2mm <sup>2</sup> 3.5mm
<b>29:</b>	Silicone 2.5mm <sup>2</sup> 4mm

Patch Cords

**TEST PROBE PATCH CORDS (PTM/BM)**

Cable types: PVC, 1mm<sup>2</sup>, 3.5mm insulation

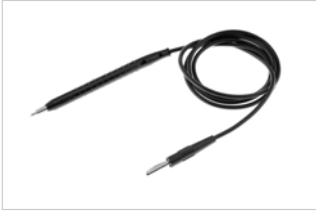

Part number	Color	Cord Length
R948 250 000	Black	100cm
R948 251 000	Red	100cm

**MADE-TO-ORDER PATCH CORDS**

The series comprises the following extremities: BM, BDM, DM. Choices include connector style, cable type, color, and cable length.

**HOW TO ORDER**

CONNECTOR 1	CABLE TYPE	LENGTH	CONNECTOR 2
<p><b>BM type</b></p> <p>R949 000 / Black R949 001 / Red R949 003 / Blue</p>	<p><b>BDM type</b></p> <p>R949 100 / Black R949 101 / Red</p>	<p><b>DM type</b></p> <p>R949 500 / Black R949 501 / Red</p>	
	<p><b>PVC 1mm<sup>2</sup> cross section: C 290 11x</b> x=0: Black, 1: Red, 2: Green, 3: Blue, 4: Yellow</p>		
	<p><b>PVC 2mm<sup>2</sup> cross section: C 290 10x</b> x=0: Black, 1: Red, 2: Green, 3: Blue, 4: Yellow</p>		
		<p><b>xxx cm:</b> over cable length in centimeter</p>	

**BM type**  
R949 000 / Black  
R949 001 / Red  
R949 003 / Blue

**BDM type**  
R949 100 / Black  
R949 101 / Red

**DM type**  
R949 500 / Black  
R949 501 / Red

**EXAMPLE TO ORDER:**  
1 black BDSR plug / green PVC 1mm<sup>2</sup> with 80cm / 1 Red BDM plug.  
Part number: R949 100 / C290 012-80cm / R949101

**For free end:** please write the word "free"

Accessories

**FEMALE / FEMALE ADAPTERS**

These adapters allow for the connection between two standard patch cords with BM extremities.

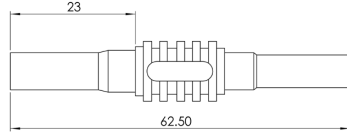

Part number	Color
R941 960 600	Black
R941 961 600	Red

**TEST CLIPS**

Figure	Description	Part number	Color	Series
	With sliding hook	R999 700 600	Black	4mm safety series
		R999 701 600	Red	
	With alligator test clip	R999 710 600	Black	
		R999 711 600	Red	
	With flexible steel rod test clip	R999 720 600	Black	
		R999 721 600	Red	
	Safety test probe	R941 850 600	Black	
		R941 851 600	Red	
	Safety test probe	R941 850 000	Black	4mm standard series
		R941 851 000	Red	

## Introduction

Radiall's high-quality and reliable 2mm series are designed for high-density test and measurement applications. This series includes a wide range of plugs, sockets, patch cords, test accessories, multiway connectors, short-circuit link, and other configurations.

- Plugs
- Sockets
- Patch cords
- PCB test points
- 20-way fixed connector
- Short circuit links
- Contact block and ribbon patch cords
- Accessories



## 20-WAY FIXED CONNECTORS



These connectors contain twenty 2mm sockets molded into a low-profile housing. The tight pitch between sockets makes them particularly suitable for use in circuit breakers and test batteries.

### ADVANTAGES:

- Quick assembly time with single mounting operation for multi-connections
- Space savings
- Simplified panel piercing
- Orientation of solder shafts



Has the potential to be able to remove the cable harness without disconnecting each socket.

## SHORT-CIRCUIT U LINKS



The short-circuit U link is a complementary component to the 20-way fixed connector and can be used to make shunts. It is fitted with a rear-mounted 2mm socket.

## Introduction

### 2mm CONTACT BLOCKS AND RIBBON PATCH CORDS SERIES

This series includes: contact blocks and ribbon patch cords.

Dimensions of contact outlets and projections.

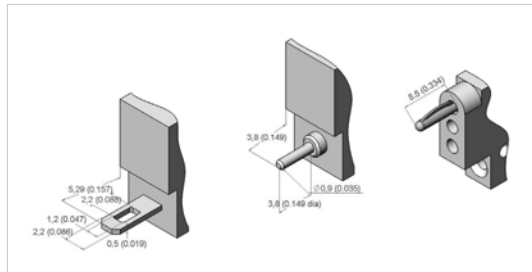
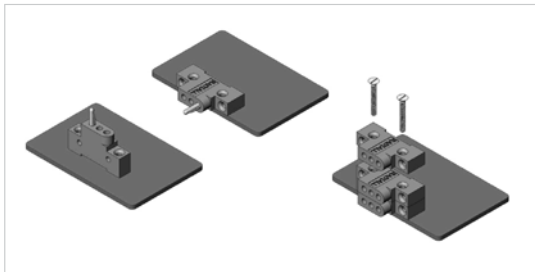

### RIBBON PATCH CORDS

The contact blocks can mate with ribbon patch cords, which have:

- Excellent contact
- Sturdy construction
- Contact polarization options
- Low bulk
- High retention

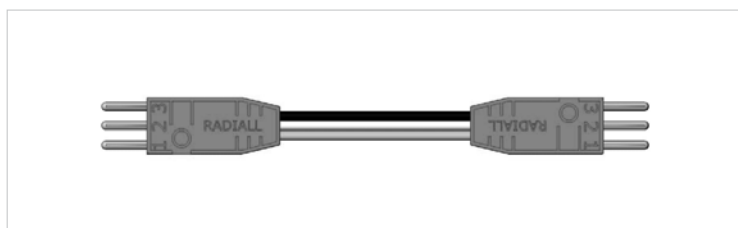

They can be used for several field applications such as: electronics, laboratories, education and telecommunications.

### PCB TEST SOCKET ACCESSORIES

Test sockets simplify testing and maintenance of equipment where direct contact with components should be avoided.

- **Test Socket entrax 10.16mm:** This model, with the particular disposition of the pins, allows the immobilization on the circuit board. This version is particularly adapted for a wave soldering operation.
- **Test Socket entrax 5.08mm:** This test socket is made up of a joined spiral spring with a nickel over plated protection.

### TEST PROBE ACCESSORIES

An extra thin probe allows contact through coatings and some insulations. It can also be used for PCB measurements. They are fitted with a rear-mounted 2mm socket and can be used with BLM and BLDM patch cords.

## Characteristics

	Plugs	Sockets	Patch Cords
--	-------	---------	-------------

**ELECTRICAL CHARACTERISTICS**

Current rating, max.	10A (@ 20 °C)	PVC cable 0.3mm <sup>2</sup> section	5A (@ 20 °C)
Dielectric withstanding voltage	1500 Vrms @ 50Hz		
Operating voltage	250 Vrms @ 50Hz		
Insulation resistance, min.	5000 MΩ		
Contact resistance, max.	1mΩ	-	

**MECHANICAL CHARACTERISTICS**

Mechanical, durability, min.	10,000 matings		
Average insertion force	14N		

**ENVIRONMENTAL CHARACTERISTICS**

Temperature range	Uninsulated -65 °C / +155 °C Insulated models -60 °C / +100 °C	-40 °C / +70 °C	
-------------------	---	-----------------	--

**MATERIALS**

Insulation	Thermoplastic		
Contacts	Nickel or tin plated Copper alloy/brass		

**ELECTRICAL CHARACTERISTICS**

	20-way Fixed Connector	Short-Circuit U Links
Current rating max	7A (@20 °C)	
Dielectric withstanding voltage	2000 Vrms 50Hz	
Operating voltage	500 Vrms 50Hz	
Insulation resistance	5000 MΩ	

**MECHANICAL CHARACTERISTICS**

Mechanical endurance	10,000 matings		
----------------------	----------------	--	--

**ENVIRONMENTAL CHARACTERISTICS**

Temperature range	-40 °C/+125 °C	-40 °C/+70 °C	
-------------------	----------------	---------------	--

**MATERIAL**

Insulation	Self-extinguishable PBT UL 94V0	PVC	
Contacts	Brass with gold plating	Brass/Bronze	

## Characteristics

## CONTACT BLOCKS &amp; RIBBON PATCH CORDS

## ELECTRICAL CHARACTERISTICS

Current rating, max. • Contact blocks • Ribbon patch cords	7A (@ 20°C) 5A (@ 20°C)
Dielectric withstanding voltage	1500 Vrms @ 50Hz
Operating voltage	250 Vrms @ 50Hz
Insulation resistance (insulated models)	5000 MΩ
Contact resistance	1mΩ

## MECHANICAL CHARACTERISTICS

Endurance	>10,000 matings
-----------	-----------------

## ENVIRONMENTAL CHARACTERISTICS

Temperature range • Contact blocks • Ribbon patch cords	-65°C / +120°C -40°C / +85°C
---	---------------------------------

## MATERIALS

Insulation	Thermoplastic
Body	Nickel or tin plated (solder connection) Copper alloy / brass

## ACCESSORIES

## ELECTRICAL CHARACTERISTICS

	PCB Test Sockets	Test Probe
Dielectric withstand voltage • Extra 10.16 model • Other models	1500 Vrms 50Hz 1000 V	1000 Vrms -
Operating voltage	250 Vrms 50Hz	250 Vrms 50Hz

## MECHANICAL

Insulation resistance	10,000MΩ	5000MΩ
-----------------------	----------	--------

## ENVIRONMENTAL

Operating temperature	-40°C / +100°C	-25°C / +70°C
-----------------------	----------------	---------------

## Packaging

Plugs	100 pieces (except BDR-2=10 pieces)
PCB test sockets	100 pieces
Patch cords	10 pieces
20-way fixed connector	1 piece
Short-circuit u links	100 pieces
PCB test sockets	100 pieces
Test probe	10 pieces
Contact blocks	50 pieces
Ribbon patch cords	10 pieces

## Plugs

## UNINSULATED BANANA PLUGS

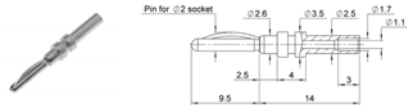
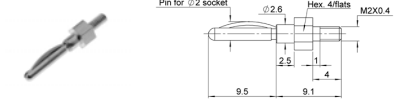
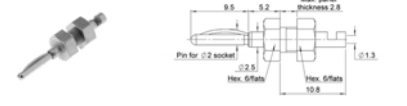
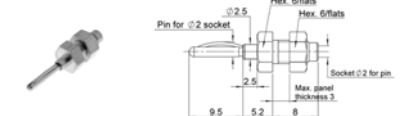
Figure	Part number	Description	Panel drilling
	R921 019 000	Solder or crimp Strip length: 4mm Crimp tool: Buchanan R612 548 000 Positioner Radiall R282 982 000 Cable: AWG 20, 22, 24	-
	R921 029 000	Threaded Rear length 4mm	-
	R921 119 000	Nut-tin-plated solder Strip length: 4mm Cable: AWG 20	P03
	R921 149 000	Male-female adapter with nut	P03

## INSULATED BANANA PLUGS

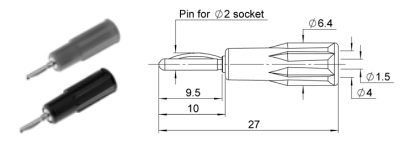
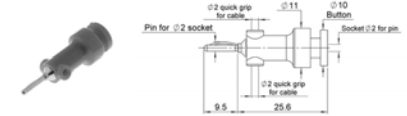
Figure	Part number	Color	Description	Panel drilling
	R921 330 000	Black	Tin-plated solder Cable: AWG 20	-
	R921 331 000	Red		
	R921 332 000	Green		
	R921 333 000	Blue		
	R921 334 000	Yellow		
	R921 336 000	White		
	R921 461 000	Red	Stackable plug with quick grip clamp 2mm rear socket	-



Sockets

UNINSULATED BANANA SOCKETS

Figure	Part number	Description	Panel drilling
	R921 609 000	Tin-plated solder Panel mount: M3.5 x 0.35 thread Strip length: 4mm Cable: AWG 20	P04
	R921 629 000	Tin-plated solder Panel mount: M4 x 0.5 thread Strip length: 4mm Cable: AWG 20	P03

INSULATED BANANA SOCKETS

Figure	Part number	Color	Description	Panel drilling
	R921 920 000	Black	Machined panel-mount socket Tin-plated solder termination Strip length: 4mm Cable: AWG 20	P02
	R921 921 000	Red		
	R921 922 000	Green		
	R921 923 000	Blue		
	R921 924 000	Yellow		
	R921 926 000	White		
	R921 930 000	Black	Stamped panel-mount socket Tin-plated solder termination Strip length: 4mm AWG 20 wire	P02
	R921 931 000	Red		
	R921 932 000	Green		
	R921 933 000	Blue		
	R921 934 000	Yellow		
	R921 936 000	White		

Patch Cords

Except where specified, all patch cords lengths are defined by the length of the cable without connectors or strain relief.

Radiall Patch Cord Series includes:

- **BLM**: Molded miniature extension patch cords
- **BLDM**: Molded miniature stackable patch cords
- **Patch cords made-to-order**

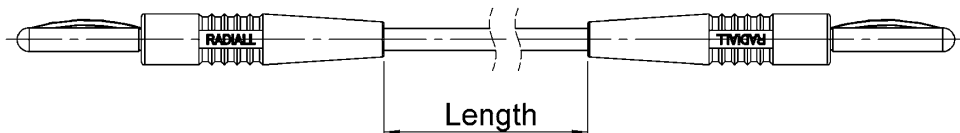

Each plug is soldered onto the cable in order to assure an excellent electrical connection with very stable transfer resistance.

Plugs

**MOLDED EXTENSION (BLM)**

Cable: PVC cable 0.3 mm<sup>2</sup>



**R928 0xx 000**

**MOLDED STACKABLE (BLDM)**

Cable: PVC cable 0.3 mm<sup>2</sup>

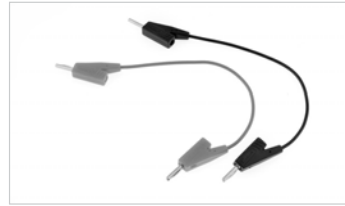

**R928 1xx 000**

PATCH CORDS LENGTH:  
**1:** 10cm  
**5:** 100cm

COLOR:  
**0:** Black  
**1:** Red  
**3:** Blue

PATCH CORDS LENGTH:  
**1:** 10cm  
**2:** 20cm  
**4:** 50cm  
**5:** 100cm

COLOR:  
**0:** Black  
**1:** Red  
**2:** Green  
**3:** Blue  
**4:** Yellow

**MADE-TO-ORDER PATCH CORDS**

Customized patch cords using BLM, BLDM, or DLM plugs can be made-to-order to your specifications. Choices include connector style, cable type, color, and cable length. Packaging: 10 identical patch cords.

**HOW TO ORDER**

	CONNECTOR 1	CABLE TYPE	LENGTH	CONNECTOR 2
<b>BM type</b> R929 000 / Black R929 001 / Red				
<b>BDLM type</b> R929 100 / Black R929 101 / Red				
<b>DLM type</b> R929 500 / Black R929 501 / Red				
<b>PVC section 0.3mm<sup>2</sup>:</b> C 290 00x x=0: Black, 1: Red, 2: Green, 3: Blue, 4: Yellow				
<b>xxx cm:</b> over cable length in centimeter				
<b>BM type</b> R929 000 / Black R929 001 / Red				

**EXAMPLE TO ORDER:**

1 black BLM extremity / red PVC cable length 40cm / 1 red BLM plug.  
 Part number: R929 000 / C290 001-40cm / R929501

**BDM type**  
 R929 100 / Black  
 R929 101 / Red

**DM type**  
 R929 500 / Black  
 R929 501 / Red

**For free end:** please write the word "free"

2 mm Series

20-WAY FIXED CONNECTORS

12 MM CONTACT PITCH

FIGURE	PART NUMBER	COLOR	TERMINATION
	R929 991 000	Blue	Solder cup
	R929 991 001	Red	
	R929 991 002	Green	
	R929 991 003	Black	
	R929 991 004	Yellow	
	R929 992 000	Blue	Pin

6 MM CONTACT PITCH

FIGURE	PART NUMBER	COLOR	TERMINATION
	R929 993 000	Blue	Solder cup
	R929 993 001	Red	
	R929 993 002	Green	
	R929 993 003	Black	
	R929 994 003	Black	Pin

SHORT-CIRCUIT U LINK

12 MM CONTACT PITCH

FIGURE	PART NUMBER	COLOR
	R644 543 000	Blue
	R644 543 001	Red
	R644 543 002	Green
	R644 543 003	Black
	R644 543 004	Yellow

6 MM CONTACT PITCH

FIGURE	PART NUMBER	COLOR
	R644 543 020	Blue
	R644 543 021	Red
	R644 543 022	Green
	R644 543 023	Black
	R644 543 024	Yellow

2 mm Series

**CONTACT BLOCKS**

The contact blocks are available for different types of connections:

- Wire soldering
- Straight pins for PCB
- Elbow pins for PCB (contact your Radiall sales representative)
- Wrapping pins (contact your Radiall sales representative)

**MALE CONTACT BLOCKS**

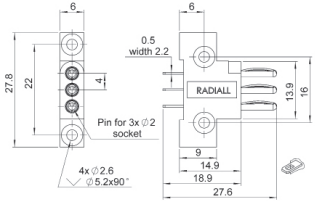
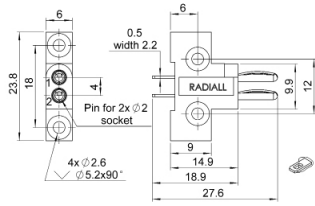
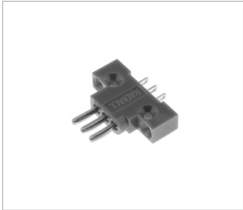

PART NUMBER	NOTE
R644 020 000	Tin-plated solder cup
R644 030 000	

**FEMALE CONTACT BLOCKS**

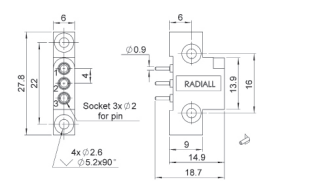
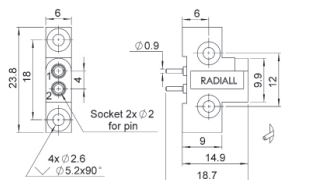
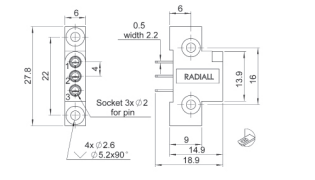
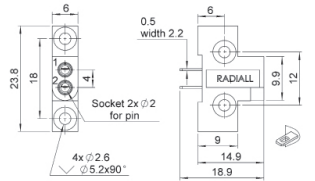
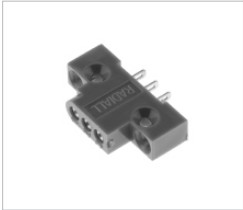

PART NUMBER	NOTE
R644 120 000	Tin-plated solder cup
R644 130 000	
R644 121 000	PCB Pins
R644 131 000	



**Ribbon Patch Cords**

The contact blocks are available for different types of connections:

**MALE-MALE RIBBON PATCH CORDS 100cm LENGTHS**

Figure	Part number	Destination	Number of contact
	R644 823 000	ML 2 MM	2
	R644 833 000	ML 3 MM	3

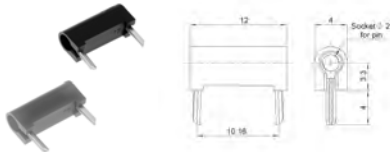
**Accessories****TEST SOCKETS AND TEST PROBE**

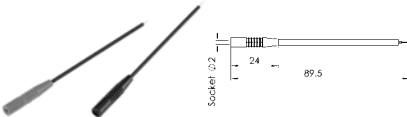
Figure	Part number	Color	Description
	R921 910 000	Black	Test socket entrax 10.16mm
	R921 911 000	Red	
	R921 912 000	Green	
	R921 913 000	Blue	
	R921 914 000	Yellow	
	R921 914 000	White	
	R921 820 070	Black	Test socket entrax 5.08mm
	R921 820 071	Red	
	R921 820 072	Green	
	R921 820 073	Blue	
	R921 820 074	Yellow	
	R921 820 076	White	
	R921 850 000	Black	Test probe
	R921 851 000	Red	

## Banana Adapters

## INTRODUCTION

The connection may be attached to a coaxial line. You will find at the end of the catalog the adapters which allow connecting between 2 mm and 4 mm or between BNC coaxial connectors with banana plugs for both 2 mm and 4 mm connectors.



## CHARACTERISTICS

	2 MM / 4 MM ADAPTER	BNC / 2 MM ADAPTER	BNC / 4 MM ADAPTER	ADAPTER PATCH CORDS
--	---------------------	--------------------	--------------------	---------------------

## ELECTRICAL CHARACTERISTICS

Current rating, max.	10A (@ 20 °C)	-	5A (@ 20 °C)
Dielectric withstanding voltage	1500 Vrms @ 50 Hz	Two: 2500 Vrms @50 Hz One-way: 750 Vrms @50 Hz	1500 Vrms @ 50 Hz
Operating voltage	250 Vrms @ 50 Hz	-	250 Vrms @ 50 Hz
Insulation resistance (insulated models)	5000 MΩ	Two: 5000 MΩ One-way: 5000 MΩ	5000 MΩ

## ENVIRONMENTAL CHARACTERISTICS

Temperature range	-40 °C / +70 °C	-40 °C / +100 °C	-40 °C / +70 °C
-------------------	-----------------	------------------	-----------------

## MATERIALS

Insulator (banana plug / socket side)	Thermoplastic
Electrical contacts	Nickel or tin plated Copper alloy/brass

## PACKAGING

DESCRIPTION	PACKAGING
2 mm / 4 mm	100 pieces
BNC / 2 mm	1 piece
BNC / 2 mm	1 piece
Patch cords	10 pieces

## Adapters

## 2MM PIN TO 4MM SOCKET ADAPTERS

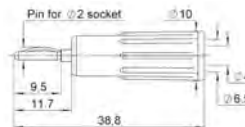
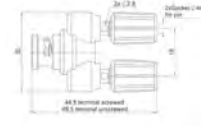

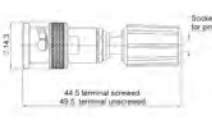

Figure	Part number	Color	Note
 	R921 390 000	Black	2mm male - 4mm female adapter
	R921 391 000	Red	

## 2MM TO BNC ADAPTERS

Figure	Part number	Color	Note
 	R191 450 000	Black	Packaging individually

## 4MM TO BNC ADAPTERS

These adaptors are designed to uncouple electric signals from input and output terminals of a measuring device fitted with male or female BNC fixed connectors.

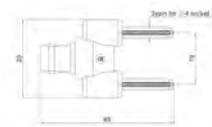

Figure	Part number	Note
 	R191 453 000	BNC: male Banana: two 4mm sockets
 	R191 454 000	BNC: male Banana: one 4mm socket
 	R191 455 000	BNC: female Banana: two 4mm plugs

## Patch Cords

**BANANA ADAPTER PATCH CORDS**

Patch cords are designed to provide continuity between two pieces of equipment or create patch cords with 2mm interfaces on one end and 4mm interface on the other.

Cable Type: 0.3 mm<sup>2</sup>, PVC

Figure	Part number	Color	Configuration
	R999 251 000	Red	BLM / BM 100cm length
	R999 350 000	Black	BLDM / BDM 100cm length
	R999 351 000	Red	
	R999 352 000	Green	
	R999 353 000	Blue	
	R999 354 000	Yellow	
	R999 520 000	Black	BLM / DM 20cm length
	R999 521 000	Red	

**COAXIAL PATCH CORDS/4mm BANANA PLUG****BCX COAXIAL PATCH CORDS**

The BCX coaxial cords are normally connected to the terminals of measuring devices in order to uncouple the central core from the braid of a coaxial cable. The BCX plug is non-removable. The cable core is soldered to the center contact and the braid is soldered to the socket.

Figure	Part number	Color	Configuration
	R948 450 000	Black	Length: 100cm (with connectors)



## Panel Drilling

P01

PANEL CUT OUT



	mm	
	Maxi	mini
A	6.2	6.1

P02

PANEL CUT OUT

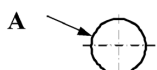

	mm	
	Maxi	mini
A	5.2	5.1

P03

PANEL CUT OUT

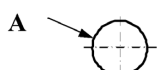

	mm	
	Maxi	mini
A	4.2	4.1

P04

PANEL CUT OUT



	mm	
	Maxi	mini
A	3.7	3.6

P05

PANEL CUT OUT

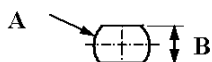

	mm	
	Maxi	mini
A	12.2	12.1
B	11.2	11.1

P06

PANEL CUT OUT

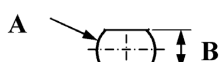

	mm	
	Maxi	mini
A	8.2	8.1
B	7.2	7.1

NOTE



# NOTE



# INDEX

---



**Radiall Part Numbers****ACCESSORIES**

99762..... 17-19  
 240 92 671 ..... 17-22  
 240 92 672 ..... 17-22  
 240 92 673 ..... 17-22  
 240 92 674 ..... 17-22  
 240 92 675 ..... 17-22  
 240 92 676 ..... 17-22  
 240 92 677 ..... 17-22  
 240 92 678 ..... 17-22  
 240 92 682 ..... 17-22  
 240 92 684 ..... 17-22  
 240 94 681 ..... 17-22  
 241 92 040 ..... 17-22  
 A240 92 010..... 17-22

**SMC**

1001-1551-002 ..... 6-26  
 1001-1551-003 ..... 6-26  
 1001-1551-005 ..... 6-26  
 1001-1551-019 ..... 6-26  
 1001-1571-002 ..... 6-26  
 1001-1571-003 ..... 6-26  
 1001-1571-005 ..... 6-26  
 1001-1571-009 ..... 6-26  
 1001-1571-010 ..... 6-26  
 1001-1571-019 ..... 6-26  
 1001-7551-002 ..... 6-26  
 1001-7551-003 ..... 6-26  
 1001-7551-005 ..... 6-26  
 1001-7551-019 ..... 6-26  
 1001-7571-002 ..... 6-26  
 1001-7571-003 ..... 6-26  
 1001-7571-005 ..... 6-26  
 1001-7571-009 ..... 6-26  
 1001-7571-010 ..... 6-26  
 1001-7571-019 ..... 6-26  
 1002-1541-009 ..... 6-25  
 1002-1541-010 ..... 6-25  
 1002-1551-002 ..... 6-25  
 1002-1551-003 ..... 6-25

1002-1551-005 ..... 6-25  
 1002-1551-019 ..... 6-25  
 1002-1571-002 ..... 6-25  
 1002-1571-003 ..... 6-25  
 1002-1571-005 ..... 6-25  
 1002-1571-019 ..... 6-25  
 1002-7541-009 ..... 6-25  
 1002-7541-010 ..... 6-25  
 1002-7551-002 ..... 6-25  
 1002-7551-003 ..... 6-25  
 1002-7551-005 ..... 6-25  
 1002-7551-019 ..... 6-25  
 1002-7571-002 ..... 6-25  
 1002-7571-003 ..... 6-25  
 1002-7571-005 ..... 6-25  
 1002-7571-019 ..... 6-25  
 1003-1541-009 ..... 6-27  
 1003-1541-010 ..... 6-27  
 1003-1551-002 ..... 6-26  
 1003-1551-003 ..... 6-26  
 1003-1551-005 ..... 6-26  
 1003-1551-019 ..... 6-27  
 1003-1571-002 ..... 6-26  
 1003-1571-003 ..... 6-26  
 1003-1571-005 ..... 6-26  
 1003-1571-019 ..... 6-27  
 1003-7541-009 ..... 6-27  
 1003-7541-010 ..... 6-27  
 1003-7551-002 ..... 6-26  
 1003-7551-003 ..... 6-26  
 1003-7551-005 ..... 6-26  
 1003-7551-019 ..... 6-27  
 1003-7571-002 ..... 6-26  
 1003-7571-003 ..... 6-26  
 1003-7571-005 ..... 6-26  
 1003-7571-019 ..... 6-27  
 1004-1511-000 ..... 6-27  
 1004-7511-000 ..... 6-27  
 1005-1541-009 ..... 6-25  
 1005-1541-010 ..... 6-25  
 1005-1551-002 ..... 6-25  
 1005-1551-003 ..... 6-25

1005-1551-005 ..... 6-25  
 1005-1551-019 ..... 6-25  
 1005-7541-009 ..... 6-25  
 1005-7541-010 ..... 6-25  
 1005-7551-002 ..... 6-25  
 1005-7551-003 ..... 6-25  
 1005-7551-005 ..... 6-25  
 1005-7551-019 ..... 6-25  
 1006-1541-009 ..... 6-27  
 1006-1541-010 ..... 6-27  
 1006-1551-002 ..... 6-26  
 1006-1551-003 ..... 6-26  
 1006-1551-005 ..... 6-26  
 1006-1551-019 ..... 6-27  
 1006-7541-009 ..... 6-27  
 1006-7541-010 ..... 6-27  
 1006-7551-002 ..... 6-26  
 1006-7551-003 ..... 6-26  
 1006-7551-005 ..... 6-26  
 1006-7551-019 ..... 6-27  
 1009-1511-000 ..... 6-28  
 1009-1511-005 ..... 6-28  
 1009-7511-000 ..... 6-28  
 1009-7511-005 ..... 6-28  
 1010-1511-000 ..... 6-28  
 1010-1511-001 ..... 6-28  
 1010-7511-000 ..... 6-28  
 1010-7511-001 ..... 6-28  
 1012-1511-000 ..... 6-27  
 1012-7511-000 ..... 6-27  
 1017-1511-000 ..... 6-27  
 1017-7511-000 ..... 6-27  
 1019-1511-000 ..... 6-27  
 1019-7511-000 ..... 6-27  
 1036-1511-051 ..... 19-6  
 1105-1521-002 ..... 6-25  
 1105-1521-003 ..... 6-25  
 1105-1521-005 ..... 6-25  
 1105-1521-019 ..... 6-25  
 1105-7521-002 ..... 6-25  
 1105-7521-003 ..... 6-25  
 1105-7521-005 ..... 6-25

1105-7521-019 ..... 6-25  
 1106-1521-002 ..... 6-26  
 1106-1521-003 ..... 6-26  
 1106-1521-005 ..... 6-26  
 1106-1521-019 ..... 6-27  
 1106-7521-002 ..... 6-26  
 1106-7521-003 ..... 6-26  
 1106-7521-005 ..... 6-26  
 1106-7521-019 ..... 6-27  
 1109-1511-000 ..... 6-28  
 1109-7511-000 ..... 6-28  
 1110-1511-000 ..... 6-28  
 1110-7511-000 ..... 6-28  
 1484-1511-000 ..... 6-27  
 1484-7511-000 ..... 6-27  
 1486-1511-000 ..... 6-27  
 1486-7511-000 ..... 6-27  
 1488-1511-000 ..... 6-27  
 1488-7511-000 ..... 6-27  
 1490-1511-000 ..... 6-27  
 1490-7511-000 ..... 6-27

**SMB**

001-1571-002 ..... 6-12  
 2001-1571-003 ..... 6-12  
 2001-1571-005 ..... 6-12  
 2001-1571-019 ..... 6-12  
 2001-7571-002 ..... 6-12  
 2001-7571-003 ..... 6-12  
 2001-7571-019 ..... 6-12  
 2002-1541-009 ..... 6-9  
 2002-1541-010 ..... 6-9  
 2002-1551-002 ..... 6-9  
 2002-1551-003 ..... 6-9  
 2002-1551-005 ..... 6-9  
 2002-1551-019 ..... 6-9  
 2002-1571-002 ..... 6-8  
 2002-1571-003 ..... 6-8  
 2002-1571-005 ..... 6-8  
 2002-1571-019 ..... 6-8  
 2002-7541-009 ..... 6-9  
 2002-7541-010 ..... 6-9

**Radiall Part Numbers**

2002-7551-002 ..... 6-9	2010-7511-002 ..... 6-16	<b>N</b>	5917-1103-000 ..... 7-35
2002-7551-003 ..... 6-9	2012-1511-000 ..... 6-15	4000-1563-009 ..... 10-7	5917-9103-000 ..... 7-35
2002-7551-019 ..... 6-9	2012-7511-000 ..... 6-15	4000-1563-010 ..... 10-7	5918-1103-000 ..... 7-35
2002-7571-002 ..... 6-8	2014-1511-000 ..... 6-14	4000-7071-019 ..... 11-11	5918-9103-000 ..... 7-35
2002-7571-003 ..... 6-8	2014-7511-000 ..... 6-14	4501-7051-003 ..... 11-15	5919-1503-000 ..... 7-35
2002-7571-005 ..... 6-8	2019-1511-000 ..... 6-14	4501-9543-009 ..... 10-7, 11-16	5919-1503-001 ..... 7-35
2002-7571-019 ..... 6-8	2019-7511-000 ..... 6-14	4502-7041-009 ..... 11-16	5919-1503-003 ..... 7-35
2003-1541-009 ..... 6-13	2025-1511-000 ..... 6-15	4502-7041-010 ..... 11-16	5919-9503-000 ..... 7-35
2003-1541-010 ..... 6-13	2025-7511-000 ..... 6-15	4502-7051-003 ..... 11-15	5919-9503-001 ..... 7-35
2003-1551-002 ..... 6-13	2041-1541-009 ..... 6-11		5919-9503-003 ..... 7-35
2003-1551-003 ..... 6-13	2041-1541-010 ..... 6-11	<b>ADAPTERS</b>	5938-1503-000 ..... 16-7
2003-1551-005 ..... 6-13	2041-1551-002 ..... 6-11	5207-1501-000 ..... 6-17, 16-10	5945-9503-000 ..... 16-7
2003-1551-019 ..... 6-13	2041-1551-003 ..... 6-11	5207-7501-000 ..... 6-17	5964-9513-001.2-10,16-7
2003-1571-002 ..... 6-12	2041-7541-010 ..... 6-11	5208-1501-000 ..... 6-17, 16-10	5965-9513-000.2-10,16-7
2003-1571-003 ..... 6-12	2041-7551-003 ..... 6-11	5208-7501-000 ..... 6-17	<b>TNC</b>
2003-1571-005 ..... 6-12	2105-1521-002 ..... 6-10	5208-7501-000 ..... 6-17, 16-10	6001-7041-010 ..... 11-30
2003-1571-019 ..... 6-12	2105-1521-003 ..... 6-10	5208-7501-000 ..... 6-17, 16-10	6001-7051-003 ..... 11-30
2003-7541-010 ..... 6-13	2105-1521-003 ..... 6-10	5213-7501-000 ..... 6-17	6002-7051-002 ..... 11-30
2003-7551-002 ..... 6-13	2105-1521-019 ..... 6-10	5215-1501-000 ..... 6-17, 16-10	6002-7051-003 ..... 11-30
2003-7551-003 ..... 6-13	2105-7521-002 ..... 6-10	5215-7501-000 ..... 6-17	6002-7551-106 ..... 11-30
2003-7571-002 ..... 6-12	2105-7521-003 ..... 6-10	5216-1501-000 ..... 6-17, 16-10	6002-7551-202 ..... 11-30
2003-7571-003 ..... 6-12	2105-7521-005 ..... 6-10	5216-7501-000 ..... 6-17	6002-7551-219 ..... 11-30
2003-7571-005 ..... 6-12	2105-7521-019 ..... 6-10	5222-1501-000 ..... 6-17, 16-10	<b>BNC</b>
2003-7571-019 ..... 6-12	2106-1521-002 ..... 6-13	5222-7501-000 ..... 6-17	6500-7071-046 ..... 9-25
2004-1511-000 ..... 6-14	2106-1521-003 ..... 6-13	5402-1501-000 ..... 16-6	6501-6571-103 ..... 9-19
2004-7511-000 ..... 6-14	2106-1521-019 ..... 6-13	5403-1501-000 ..... 16-6	6501-7551-219 ..... 9-19
2005-1541-009 ..... 6-11	2106-7521-002 ..... 6-13	5404-1501-000 ..... 16-6	<b>SSMC</b>
2005-1541-010 ..... 6-11	2106-7521-003 ..... 6-13	5405-1501-000 ..... 16-6	7001-1541-010 ..... 12-13
2005-1551-002 ..... 6-11	2106-7521-019 ..... 6-13	5510-1501-000 ..... 16-6	7002-1542-010 ..... 12-13
2005-1551-003 ..... 6-11	2109-1511-000 ..... 6-15	5512-7501-000 ..... 16-6	7002-1542-011 ..... 12-13
2005-1551-019 ..... 6-11	2109-7511-000 ..... 6-15	5822-1501-000 ..... 6-28	7002-1571-002 ..... 12-13
2005-7541-009 ..... 6-11	2141-1521-002 ..... 6-10	5909-1103-000 ..... 7-35	7002-1571-003 ..... 12-13
2005-7541-010 ..... 6-11	2141-1521-003 ..... 6-10	5909-9103-000 ..... 7-35	7002-1571-019 ..... 12-13
2005-7551-002 ..... 6-11	2141-1521-019 ..... 6-10	5916-1103-603 ..... 7-35	7002-1572-002 ..... 12-13
2005-7551-003 ..... 6-11	2141-7521-003 ..... 6-10	5916-9103-603 ..... 7-35	7002-1572-003 ..... 12-13
2009-1511-000 ..... 6-15	2141-7521-019 ..... 6-10		7002-1572-019 ..... 12-13
2009-1511-050 ..... 6-15	2484-1511-000 ..... 6-14		7003-1542-011 ..... 12-14
2009-7511-000 ..... 6-15	2486-1511-000 ..... 6-14		7003-1572-002 ..... 12-14
2009-7511-050 ..... 6-15	2486-7511-000 ..... 6-14		
2010-1511-000 ..... 6-16			
2010-1511-002 ..... 6-16			
2010-7511-000 ..... 6-16			

**Radiall Part Numbers**

7003-1572-003 ..... 12-14	7210-1511-040 ..... 12-11	9001-1023-002 ..... 7-18	9001-9573-005 ..... 7-18
7009-1511-000 ..... 12-14	7210-1511-050 ..... 12-11	9001-1023-003 ..... 7-18	9001-9573-006 ..... 7-18
7009-1511-004 ..... 12-14	7219-1511-000 ..... 12-9	9001-1023-005 ..... 7-18	9001-9573-019 ..... 7-18
7009-1511-050 ..... 12-14	7222-1501-600 .... 12-11,	9001-1023-006 ..... 7-18	9002-1023-001 ..... 7-22
7010-1511-000 ..... 12-14	16-10	9001-1023-019 ..... 7-18	9002-1023-002 ..... 7-22
7010-1511-041 ..... 12-14	7225-1512-000 ..... 12-10	9001-1033-001 ..... 7-18	9002-1023-003 ..... 7-22
7010-1511-050 ..... 12-14	7225-1512-004 ..... 12-10	9001-1033-002 ..... 7-18	9002-1023-005 ..... 7-22
7029-1511-031 ..... 12-14	7225-1512-012 ..... 12-10	9001-1033-003 ..... 7-18	9002-1023-006 ..... 7-22
7029-1513-004 ..... 12-14	7225-1512-040 ..... 12-10	9001-1033-005 ..... 7-18	9002-1023-019 ..... 7-22
7029-1513-005 ..... 12-14	7225-1512-050 ..... 12-10	9001-1033-006 ..... 7-18	9002-1033-002 ..... 7-22
7042-1511-040 ..... 12-14	7225-1512-050 ..... 12-10	9001-1033-019 ..... 7-18	9002-1033-003 ..... 7-22
7101-1571-002 ..... 12-13	7242-1511-000 ..... 12-11	9001-1553-001 ..... 7-18	9002-1033-005 ..... 7-22
7105-1521-002 ..... 12-13	7242-1511-012 ..... 12-11	9001-1553-002 ..... 7-18	9002-1033-006 ..... 7-22
7105-1521-003 ..... 12-13	7242-1511-050 ..... 12-11	9001-1553-003 ..... 7-18	9002-1033-019 ..... 7-22
7105-1521-019 ..... 12-13	7405-1521-002 ..... 12-8	9001-1553-005 ..... 7-18	9002-9023-002 ..... 7-22
7105-1561-010 ..... 12-13	7405-1521-003 ..... 12-8	9001-1553-006 ..... 7-18	9002-9023-003 ..... 7-22
7105-1561-011 ..... 12-13	7405-1521-005 ..... 12-8	9001-1553-019 ..... 7-18	9002-9023-005 ..... 7-22
7110-1511-000 ..... 12-14	7405-1521-019 ..... 12-8	9001-1573-001 ..... 7-18	9002-9023-006 ..... 7-22
7110-1511-050 ..... 12-14	7405-1561-010 ..... 12-9	9001-1573-002 ..... 7-18	9002-9023-019 ..... 7-22
7122-1502-000 .... 12-14,	7405-1561-011 ..... 12-9	9001-1573-003 ..... 7-18	9004-1113-000 ..... 7-28
16-10	7405-2521-002 ..... 12-8	9001-1573-005 ..... 7-18	9004-1213-000 ..... 7-28
7145-1521-002 ..... 17-21	7406-1521-002 ..... 12-9	9001-1573-006 ..... 7-18	9004-9113-000 ..... 7-28
	7406-1521-003 ..... 12-9	9001-1573-019 ..... 7-18	9007-9113-000 ..... 7-28
	7406-1521-005 ..... 12-9	9001-9023-001 ..... 7-18	9008-1113-000 ..... 7-28
	7410-1511-000 ..... 12-10	9001-9023-002 ..... 7-18	9008-1213-000 ..... 7-28
	7410-1511-012 ..... 12-10	9001-9023-003 ..... 7-18	9008-9113-000 ..... 7-28
	7410-1511-040 ..... 12-10	9001-9023-005 ..... 7-18	9030-1023-001 ..... 7-24
	7410-1511-050 ..... 12-10	9001-9023-006 ..... 7-18	9030-1023-002 ..... 7-24
		9001-9023-019 ..... 7-18	9030-1023-003 ..... 7-24
		9001-9033-001 ..... 7-18	9030-1023-005 ..... 7-24
		9001-9033-002 ..... 7-18	9030-1023-006 ..... 7-24
		9001-9033-003 ..... 7-18	9030-1023-019 ..... 7-24
		9001-9033-005 ..... 7-18	9030-1033-001 ..... 7-24
		9001-9033-006 ..... 7-18	9030-1033-002 ..... 7-24
		9001-9033-019 ..... 7-18	9030-1033-003 ..... 7-24
		9001-9553-001 ..... 7-18	9030-1033-005 ..... 7-24
		9001-9553-003 ..... 7-18	9030-1033-006 ..... 7-24
		9001-9553-005 ..... 7-18	9030-1033-019 ..... 7-24
		9001-9553-006 ..... 7-18	9030-9023-001 ..... 7-24
		9001-9553-019 ..... 7-18	9030-9023-002 ..... 7-24
		9001-9573-001 ..... 7-18	9030-9023-003 ..... 7-24
		9001-9573-003 ..... 7-18	9030-9023-005 ..... 7-24

**SSMB**

7202-1542-010 ..... 12-8
7202-1542-011 ..... 12-8
7202-1572-002 ..... 12-8
7202-1572-003 ..... 12-8
7202-1572-019 ..... 12-8
7203-1541-010 ..... 12-9
7203-1541-011 ..... 12-9
7204-1511-000 ..... 12-9
7209-1511-000 ..... 12-10
7209-1511-011 ..... 12-10
7209-1511-012 ..... 12-10
7209-1511-015 ..... 12-10
7209-1511-040 ..... 12-10
7209-1511-050 ..... 12-10
7209-1511-050 ..... 12-11
7210-1511-012 ..... 12-11
7210-1511-015 ..... 12-11
7210-1511-019 ..... 12-11

**ACCESSORIES**

8045-1541-010 ..... 17-21
8045-1551-003 ..... 17-21
8145-1521-002 ..... 17-21
8145-1521-002 ..... 17-21
8145-1521-002 ..... 17-21

**MCX**

8955-1521-003 ..... 1-21
--------------------------

**SMA**

9001-1023-001 ..... 7-18
--------------------------

**Radiall Part Numbers**

9030-9023-006 ..... 7-24	9079-9513-001 ..... 7-33	9144-9513-000 ..... 7-33	9401-7583-109 ..... 7-19
9030-9023-019 ..... 7-24	9080-9513-000 ..... 7-33	9180-9513-000 ..... 7-33	9402-1083-009 ..... 7-23
9031-1023-001 ..... 7-22	9102-1573-001 ..... 7-22	9180-9513-001 ..... 7-33	9402-1083-010 ..... 7-23
9031-1023-002 ..... 7-22	9102-1573-002 ..... 7-22	920-55 ..... 7-33	9402-1583-009 ..... 7-23
9031-1023-003 ..... 7-22	9102-1573-003 ..... 7-22	920-56 ..... 7-33	9402-1583-010 ..... 7-23
9031-1023-005 ..... 7-22	9102-1573-005 ..... 7-22	920-82 ..... 7-33	9402-7083-009 ..... 7-23
9031-1023-006 ..... 7-22	9102-1573-006 ..... 7-22	9201-9573-002 ..... 7-18	9402-7083-010 ..... 7-23
9031-1023-019 ..... 7-22	9102-1573-019 ..... 7-22	9230-1553-001 ..... 7-24	9402-7583-009 ..... 7-23
9031-1033-001 ..... 7-22	9102-9573-001 ..... 7-22	9230-1553-002 ..... 7-24	9402-7583-010 ..... 7-23
9031-1033-002 ..... 7-22	9102-9573-002 ..... 7-22	9230-1553-003 ..... 7-24	9404-1113-000 ..... 7-27
9031-1033-003 ..... 7-22	9102-9573-003 ..... 7-22	9230-1553-005 ..... 7-24	9407-1113-000 ..... 7-26
9031-1033-005 ..... 7-22	9102-9573-005 ..... 7-22	9230-1553-006 ..... 7-24	9407-9113-000 ..... 7-26
9031-1033-006 ..... 7-22	9102-9573-006 ..... 7-22	9230-1553-019 ..... 7-24	9408-1113-000 ..... 7-26
9031-1033-019 ..... 7-22	9102-9573-019 ..... 7-22	9230-9553-001 ..... 7-24	9408-1113-002 ..... 7-26
9031-9023-001 ..... 7-22	9124-1513-000 ..... 7-30	9230-9553-002 ..... 7-24	9408-9113-000 ..... 7-26
9031-9023-002 ..... 7-22	9124-9513-000 ..... 7-30	9230-9553-003 ..... 7-24	9408-9113-002 ..... 7-26
9031-9023-003 ..... 7-22	9126-1513-000 ..... 7-30	9230-9553-005 ..... 7-24	9412-1113-000 ..... 7-27
9031-9023-005 ..... 7-22	9126-9513-000 ..... 7-30	9230-9553-006 ..... 7-24	9412-9113-000 ..... 7-27
9031-9023-006 ..... 7-22	9130-1573-001 ..... 7-24	9230-9553-019 ..... 7-24	9422-1113-000 ..... 7-27
9031-9023-019 ..... 7-22	9130-1573-002 ..... 7-24	9243-1553-001 ..... 7-20	9422-9113-000 ..... 7-27
9043-1523-001 ..... 7-20	9130-1573-003 ..... 7-24	9243-1553-002 ..... 7-20	9424-1513-000 ..... 7-26
9043-1523-002 ..... 7-20	9130-1573-005 ..... 7-24	9243-1553-003 ..... 7-20	9424-9513-000 ..... 7-26
9043-1523-003 ..... 7-20	9130-1573-006 ..... 7-24	9243-1553-005 ..... 7-20	9425-1513-000 ..... 7-26
9043-1523-005 ..... 7-20	9130-1573-019 ..... 7-24	9243-1553-006 ..... 7-20	9425-9513-000 ..... 7-26
9043-1523-006 ..... 7-20	9130-9573-001 ..... 7-24	9243-1553-019 ..... 7-20	9431-1083-009 ..... 7-23
9043-1523-019 ..... 7-20	9130-9573-002 ..... 7-24	9243-9553-001 ..... 7-20	9431-1083-010 ..... 7-23
9043-1533-001 ..... 7-20	9130-9573-003 ..... 7-24	9243-9553-002 ..... 7-20	9431-1583-009 ..... 7-23
9043-1533-002 ..... 7-20	9130-9573-005 ..... 7-24	9243-9553-003 ..... 7-20	9431-1583-010 ..... 7-23
9043-1533-003 ..... 7-20	9130-9573-006 ..... 7-24	9243-9553-005 ..... 7-20	9431-7083-009 ..... 7-23
9043-1533-005 ..... 7-20	9130-9573-019 ..... 7-24	9243-9553-006 ..... 7-20	9431-7083-010 ..... 7-23
9043-1533-006 ..... 7-20	9131-1573-001 ..... 7-22	9243-9553-019 ..... 7-20	9431-7583-009 ..... 7-23
9043-1533-019 ..... 7-20	9131-1573-002 ..... 7-22	9301-1063-009 ..... 7-19	9431-7583-010 ..... 7-23
9043-9523-001 ..... 7-20	9131-1573-003 ..... 7-22	9301-7063-009 ..... 7-19	9432-1113-000 ..... 7-27
9043-9523-002 ..... 7-20	9131-1573-005 ..... 7-22	9401-1083-010 ..... 7-19	9432-9113-000 ..... 7-27
9043-9523-003 ..... 7-20	9131-1573-006 ..... 7-22	9401-1083-109 ..... 7-19	9441-1083-009 ..... 7-23
9043-9523-005 ..... 7-20	9131-1573-019 ..... 7-22	9401-1083-210 ..... 7-19	9441-1083-010 ..... 7-23
9043-9523-006 ..... 7-20	9131-9573-001 ..... 7-22	9401-1583-010 ..... 7-19	9441-1583-009 ..... 7-23
9043-9523-019 ..... 7-20	9131-9573-002 ..... 7-22	9401-1583-109 ..... 7-19	9441-1583-010 ..... 7-23
9050-9513-000 ..... 7-33	9131-9573-003 ..... 7-22	9401-7083-010 ..... 7-19	9441-7083-009 ..... 7-23
9074-9513-000 ..... 7-33	9131-9573-005 ..... 7-22	9401-7083-109 ..... 7-19	9441-7083-010 ..... 7-23
9076-9113-000 ..... 7-28	9131-9573-006 ..... 7-22	9401-7083-210 ..... 7-19	9441-7583-009 ..... 7-23
9079-9513-000 ..... 7-33	9131-9573-019 ..... 7-22	9401-7583-010 ..... 7-19	9441-7583-010 ..... 7-23



**Radiall Part Numbers**

9443-1563-009 ..... 7-21	9613-9563-009 ..... 7-25	C291 325 290 ..... 18-6	C291 999 904 ..... 18-6
9443-1563-010 ..... 7-21	9613-9563-010 ..... 7-25	C291 326 490 ..... 18-6	C291 999 905 ..... 18-6
9453-1083-009 ..... 7-25	9620-9003-151 ..... 19-6	C291 327 010.18-6,18-36	
9453-1083-010 ..... 7-25	9620-9003-251 ..... 19-6	C291 327 020.18-6,18-37	<b>UMP / IMP</b>
9453-1583-009 ..... 7-25		C291 327 030.18-6,18-38	R107 003 010 ..... 14-14
9453-1583-010 ..... 7-25	<b>SSMA</b>	C291 327 040.18-6,18-39	R107 009 901 ..... 14-145,
9453-7083-009 ..... 7-25	9765-9523-003 ..... 12-5	C291 327 050.18-6,18-40	16-4
9453-7083-010 ..... 7-25		C291 327 060.18-6,18-35	R107 009 903 ..... 14-15,
9453-7583-009 ..... 7-25	<b>CABLES</b>	C291 330 000 ..... 18-6	16-4
9453-7583-010 ..... 7-25	C290 00x ..... 20-25	C291 333 039 ..... 18-7	R107 064 070 ..... 14-12
9476-1113-000 ..... 7-27	C290 010 ..... 20-13	C291 351 012 ..... 18-6	R107 064 080 ..... 14-12
9501-1593-009 ..... 7-19	C290 011 ..... 20-13	C291 360 000 ..... 18-6	R107 303 040 ..... 14-14
9501-1593-010 ..... 7-19	C290 10x ..... 20-17	C291 360 093 ..... 18-7	
9501-9593-009 ..... 7-19	C290 110 ..... 20-13	C291 384 083 ..... 18-7	<b>MMCX</b>
9501-9593-010 ..... 7-19	C290 111 ..... 20-13	C291 491 060 ..... 18-6	R110 081 020 ..... 1-16
9502-1593-010 ..... 7-23	C290 11x ..... 20-17	C291 510 000.18-6, 18-8	R110 083 120 ..... 1-16
9502-9593-009 ..... 7-23	C291 042 066 ..... 18-6	C291 510 010 ..... 18-18	R110 153 000 ..... 1-16
9502-9593-010 ..... 7-23	C291 050 066 ..... 18-6	C291 511 007.18-6,18-19	R110 170 100 ..... 1-16
9530-1593-009 ..... 7-25	C291 055 076 ..... 18-6	C291 512 020 ..... 18-6	R110 170 147 ..... 15-19
9530-1593-010 ..... 7-25	C291 140 087.15-24,18-6	C291 600 000.18-6,18-19	R110 172 100 ..... 1-16
9530-9593-009 ..... 7-25	C291 145 007 ..... 18-6	C291 600 010.18-6, 18-19	R110 422 100 ..... 1-16
9530-9593-010 ..... 7-25	C291 145 017 ..... 18-6	C291 610 000.18-6,18-20	R110 426 000 ..... 1-17
9543-1593-009 ..... 7-21	C291 146 087 ..... 18-6	C291 844 065 ..... 18-7	R110 426 107 ..... 15-19
9543-1593-010 ..... 7-21	C291 147 060 ..... 18-6	C291 844 187 ..... 18-7	R110 427 810 ..... 1-17
9543-9593-009 ..... 7-21	C291 150 000 ..... 18-6	C291 850 001 ..... 18-7	R110 427 820 ..... 1-17
9543-9593-010 ..... 7-21	C291 150 010 ..... 18-6	C291 850 005 ..... 18-7	R110 434 100 ..... 1-16
9609-1513-000 ..... 7-27	C291 150 007 ..... 18-6	C291 851 001 ..... 15-24,	R110 434 860 ..... 1-16
9609-9513-000 ..... 7-27	C291 170 007 ..... 18-6	18-7	R110 665 860 ..... 1-17
9613-1523-001 ..... 7-25	C291 170 017 ..... 18-6	C291 855 001 ..... 18-7	R110 704 103 .1-17, 16-9
9613-1523-002 ..... 7-25	C291 170 079 ..... 15-24	C291 855 065 ..... 18-7	R110A 170 100 ..... 1-16
9613-1523-003 ..... 7-25	C291 171 083 ..... 18-6	C291 860 001 ..... 18-7	R110A 172 100 ..... 1-16
9613-1523-005 ..... 7-25	C291 185 067 ..... 18-6	C291 861 061 .5-24, 18-7	R110A 422 830 ..... 1-16
9613-1523-006 ..... 7-25	C291 210 007 ..... 18-6	C291 861 066 ..... 18-7	R110A 426 000 ..... 1-17
9613-1523-019 ..... 7-25	C291 217 020 ..... 18-6	C291 862 005 ..... 18-7	R110A 427 830 ..... 1-17
9613-1563-009 ..... 7-25	C291 305 000 ..... 18-6	C291 864 065 ..... 18-7	
9613-1563-010 ..... 7-25	C291 305 010 ..... 18-6	C291 864 187 ..... 18-7	<b>SMC</b>
9613-9523-001 ..... 7-25	C291 320 007 ..... 18-6	C291 866 378 ..... 18-7	R112 003 000 ..... 6-25
9613-9523-002 ..... 7-25	C291 320 180 ..... 18-6	C291 870 001 ..... 18-7	R112 005 000 ..... 6-25
9613-9523-003 ..... 7-25	C291 322 017 ..... 18-6	C291 874 187 ..... 18-7	R112 053 000 ..... 6-25
9613-9523-005 ..... 7-25	C291 324 007 ..... 18-6	C291 993 170 ..... 18-7	R112 075 000 ..... 6-25
9613-9523-006 ..... 7-25	C291 324 079 ..... 15-24	C291 994 170 ..... 18-7	R112 165 000 ..... 6-25
9613-9523-019 ..... 7-25	C291 325 270 ..... 18-6	C291 996 170 ..... 18-7	

**Radiall Part Numbers**

R112 183 000 .....	6-25	R113 424 020 .....	1-23	R114 413 000 .....	6-14	R121 172 000 .....	12-5
R112 186 000 .....	6-25	R113 424 097 .....	15-20	R114 416 020 .....	6-15	R121 414 000 .....	12-6
R112 205 000 .....	6-26	R113 425 000 .....	1-23	R114 423 000 .....	6-15	R121 464 000 .....	12-6
R112 303 000 .....	6-26	R113 425 097 .....	15-20	R114 424 000 .....	6-15	R121 630 003 .....	12-6
R112 305 000 .....	6-26	R113 426 000 .....	1-23	R114 424 100 .....	6-15	R121 703 000.12-6,16-10	
R112 403 000 .....	6-27	R113 426 097 .....	15-20	R114 425 000 .....	6-15	R121 705 000 .....	16-10
R112 426 000 .....	6-28	R113 427 000 .....	1-23	R114 426 000 .....	6-15	R121 705 001 .....	12-6
R112 553 000 .....	6-27	R113 553 000 .....	1-23	R114 426 147 .....	15-22		
R112 554 000 .....	6-27	R113 664 000 .....	1-24	R114 450 000 .....	6-14		
R112 665 000 .....	6-28	R113 665 000 .....	1-24	R114 504 225 .....	6-15		
R112 670 000 .....	6-27	R113 665 020 .....	1-24	R114 553 000 .....	6-14		
R112 720 000.6-28,16-10		R113 665 097 .....	15-20	R114 554 000 .....	6-14		
R112 780 000.6-28,16-10		R113 666 000 .....	1-24	R114 603 000 .....	6-14		
		R113 704 000..1-24, 16-9		R114 664 000 .....	6-16		

**MCX**

R113 053 000 .....	1-21
R113 081 000 .....	1-21
R113 081 097 .....	15-19
R113 082 000 .....	1-21
R113 082 097 .....	15-19
R113 083 000 .....	1-21
R113 151 000 .....	1-22
R113 153 000 .....	1-22
R113 161 000 .....	1-22
R113 181 000 .....	1-21
R113 181 097 .....	15-19
R113 182 000 .....	1-21
R113 182 020 .....	1-21
R113 182 097 .....	15-19
R113 183 000 .....	1-21
R113 183 020 .....	1-21
R113 223 000 .....	1-22
R113 240 000 .....	1-22
R113 240 097 .....	15-20
R113 303 000 .....	1-22
R113 306 000 .....	1-22
R113 310 000 .....	1-22
R113 312 000 .....	1-22
R113 402 220 .....	1-23
R113 423 000 .....	1-23
R113 424 000 .....	1-23
R113 424 010 .....	1-23

**SMB**

R114 003 000 .....	6-9
R114 005 000 .....	6-9
R114 053 000 .....	6-9
R114 073 000 .....	6-8
R114 075 000 .....	6-8
R114 082 000 .....	6-8
R114 082 107 .....	15-21
R114 083 000 .....	6-8
R114 163 000 .....	6-11
R114 163 420 .....	6-11
R114 165 000 .....	6-11
R114 169 000 .....	6-11
R114 182 000 .....	6-10
R114 183 000 .....	6-10
R114 185 000 .....	6-10
R114 186 000 .....	6-10
R114 186 100 .....	6-10
R114 186 197 .....	15-21
R114 187 000 .....	6-10
R114 222 000 .....	6-13
R114 238 000 .....	6-12
R114 303 000 .....	6-13
R114 303 133 .....	6-13
R114 305 000 .....	6-13
R114 313 000 .....	6-12
R114 313 197 .....	15-21

**SMB-LOCK**

R115 427 000 .....	6-21
R115 556 000 .....	6-20
R115 666 000 .....	6-21
R116 426 000 .....	6-21
R117 082 807 .....	6-20
R117 186 807 .....	6-20

**SSMA**

R121 053 000 .....	12-5
R121 072 000 .....	12-5
R121 153 000 .....	12-5

**QMA**

R123 054 000 .....	8-8
R123 055 000 .....	8-8
R123 071 000.8-8, 18-35	
R123 072 000 .....	8-8
R123 075 000 .....	8-8
R123 075 200.8-8, 18-36	
R123 076 000 .....	8-8
R123 076 310.8-8, 18-38	
R123 096 110.8-8, 18-37	
R123 141 000 .....	8-11
R123 142 000 .....	8-11
R123 153 000 .....	8-8
R123 153 003 .....	8-8
R123 154 000 .....	8-8
R123 154 003 .....	8-8
R123 172 000 .....	8-8
R123 174 000 .....	8-8
R123 175 000 .....	8-8
R123 176 000 .....	8-8
R123 177 100.8-8, 18-38	
R123 305 023...8-9, 8-14	
R123 312 000 .....	8-9
R123 313 000 .....	8-9
R123 314 000 .....	8-9
R123 314 010.8-9, 18-38	
R123 315 000 .....	8-9
R123 326 003..8-9, 8-14	
R123 415 000 .....	8-9
R123 422 801 .....	5-14
R123 425 100...8-9, 8-14	
R123 426 003 .....	8-10
R123 427 803 .....	8-10
R123 444 827 .....	8-10

**Radiall Part Numbers**

R123 464 110 ..... 8-9	R124 080 030.7-47,18-39	R124 654 003..... 7-50	R125 091 000..... 7-17
R123 553 000 ..... 8-9	R124 153 001 ..... 7-48	R124 667 143..... 7-51	R125 091 001..... 7-21
R123 590 027 ..... 8-9	R124 153 003 ..... 7-48	R124 680 120..... 7-51	R125 153 000..... 7-21
R123 680 003 ..... 8-10	R124 154 001 ..... 7-48	R124 680 123..... 7-51	R125 153 002..... 7-21
R123 682 827 ..... 8-10	R124 154 003 ..... 7-48	R124 681 000..... 7-51	R125 153 901..... 7-21
R123 682 880 ..... 8-10	R124 172 120 ..... 7-48	R124 681 800..... 7-51	R125 154 000..... 7-21
R123 703 000.8-11, 16-9	R124 172 123.7-48,18-35	R124 802 108..... 7-52	R125 154 002..... 7-21
R123 704 000.8-11, 16-9	R124 174 120 ..... 7-48		R125 154 901..... 7-20
R123 705 000.8-11, 16-9	R124 174 123 ..... 7-48	<b>SMA</b>	R125 163 200..... 7-20
R123 805 000 ..... 8-11	R124 175 110.7-48,18-36	R125 002 200 ..... 7-17	R125 170 402..... 7-20
	R124 175 120 ..... 7-48	R125 051 000 ..... 7-18	R125 172 000..... 7-20
	R124 175 123 ..... 7-48	R125 052 000 ..... 7-18	R125 172 001..... 7-20
	R124 175 200.7-48,18-37	R125 052 002 ..... 7-18	R125 174 000..... 7-20
	R124 175 310.7-48,18-38	R125 052 170 ..... 7-18	R125 175 000..... 7-20
	R124 176 120 ..... 7-48	R125 052 500 ..... 7-18	R125 175 001..... 7-20
	R124 176 123 ..... 7-48	R125 052 702 ..... 7-18	R125 176 000..... 7-20
	R124 222 003 ..... 7-48	R125 052 901 ..... 7-19	R125 176 001..... 7-20
	R124 233 123 ..... 7-48	R125 053 901 ..... 7-19	R125 176 505..... 7-20
	R124 236 123 ..... 7-48	R125 054 000 ..... 7-18	R125 222 000..... 7-23
	R124 252 003 ..... 7-49	R125 054 002 ..... 7-18	R125 225 000..... 7-23
	R124 255 003 ..... 7-49	R125 054 500 ..... 7-18	R125 225 900..... 7-23
	R124 256 003 ..... 7-49	R125 054 901 ..... 7-19	R125 236 000..... 7-21
	R124 310 023 ..... 7-49	R125 055 000 ..... 7-18	R125 237 000..... 7-21
	R124 312 120 ..... 7-49	R125 055 002 ..... 7-18	R125 238 000..... 7-21
	R124 312 123.7-49,18-35	R125 055 500 ..... 7-18	R125 251 000..... 7-23
	R124 314 120 ..... 7-49	R125 055 702 ..... 7-18	R125 252 000..... 7-23
	R124 315 120 ..... 7-49	R125 055 901 ..... 7-19	R125 255 000..... 7-23
	R124 325 003 ..... 7-49	R125 057 002 ..... 7-18	R125 256 000..... 7-23
	R124 326 003 ..... 7-49	R125 069 000 ..... 7-17	R125 272 000..... 7-21
	R124 403 123 ..... 7-50	R125 071 120 ..... 7-17	R125 277 000..... 7-21
	R124 413 025 ..... 7-50	R125 072 000 ..... 7-17	R125 303 000..... 7-24
	R124 415 273 ..... 7-50	R125 072 001 ..... 7-17	R125 303 001..... 7-24
	R124 422 001.5-14, 7-51	R125 072 080 ..... 7-17	R125 305 000..... 7-25
	R124 423 033 ..... 7-51	R125 072 220 ..... 7-17	R125 308 000..... 7-24
	R124 423 223 ..... 7-51	R125 073 000 ..... 7-17	R125 312 120..... 7-24
	R124 426 120..... 7-51	R125 073 001..... 7-17	R125 313 120..... 7-24
	R124 426 123..... 7-51	R125 075 000..... 7-17	R125 314 120..... 7-24
	R124 427 000..... 7-51	R125 076 000..... 7-17	R125 315 120..... 7-24
	R124 427 800..... 7-51	R125 076 001..... 7-17	R125 320 020..... 7-24
	R124 454 123..... 7-50	R125 077 000..... 7-17	
	R124 464 000..... 7-50	R125 078 000..... 7-17	
	R124 510 000..... 7-50	R125 078 001..... 7-17	

**WQMA**

R123W 054 000 ..... 8-14
R123W 055 000 ..... 8-14
R123W 076 310 ..... 8-14, 18-38
R123W 096 100 ..... 8-14
R123W 153 000 ..... 8-14
R123W 154 000 ..... 8-14
R123W 176 000 ..... 8-14
R123W 177 110 ..... 8-14, 18-38
R123W 805 700 ..... 8-14
R123W 805 710 ..... 8-14

**SMA-COM**

R124 052 013 ..... 7-47
R124 054 003 ..... 7-47
R124 055 003 ..... 7-47
R124 069 120 ..... 7-47
R124 069 123 ..... 7-47
R124 071 120 ..... 7-47
R124 071 123.7-47,18-35
R124 072 220 ..... 7-47
R124 075 210.7-47,18-36
R124 075 320 ..... 7-47
R124 075 323 ..... 7-47
R124 076 320 ..... 7-47
R124 076 323 ..... 7-47
R124 076 430.7-47,18-38
R124 076 450.7-47,18-37

**Radiall Part Numbers**

R125 321 020..... 7-24	R125 464 271..... 7-28	R125 612 120..... 7-29	R125 852 000..... 7-36
R125 322 030..... 7-24	R125 464 274..... 7-28	R125 617 001..... 7-31	R125 852 001..... 7-36
R125 325 000..... 7-25	R125 465 000..... 7-33	R125 620 000..... 7-29	R125 943 001..... 7-29
R125 326 000..... 7-25	R125 465 001..... 7-33	R125 622 000..... 7-29	
R125 403 000..... 7-26	R125 465 010..... 7-33	R125 630 000..... 7-34	<b>SMA 2.9</b>
R125 403 001..... 7-26	R125 465 011..... 7-33	R125 630 040..... 7-34	R127 052 001..... 10-16
R125 410 000..... 7-32	R125 474 000..... 7-29	R125 638 001..... 7-34	R127 055 001..... 10-16
R125 410 001..... 7-32	R125 474 001..... 7-29	R125 653 001..... 7-26	R127 601 001..... 10-17
R125 411 000..... 7-33	R125 480 001..... 7-32	R125 654 000..... 7-26	R127 601 421..... 10-17
R125 411 001..... 7-33	R125 481 001..... 7-33	R125 654 450..... 7-28	R127 631 001..... 10-17
R125 413 000..... 7-28	R125 481 011..... 7-33	R125 670 001..... 7-32	R127 632 001..... 10-17
R125 413 001..... 7-28	R125 483 000..... 7-27	R125 680 000..... 7-29	R127 703 001..... 10-18, 16-10
R125 414 000..... 7-28	R125 484 000..... 7-31	R125 703 000.7-35,16-10	R127 704 001..... 10-18, 16-10
R125 414 001..... 7-28	R125 484 001..... 7-31	R125 703 001.7-35,16-10	R127 705 001..... 10-18, 16-10
R125 414 004..... 7-28	R125 488 000..... 7-30	R125 704 000.7-35,16-10	
R125 415 000..... 7-28	R125 488 001..... 7-30	R125 704 001.7-35,16-10	R127 705 001..... 10-18, 16-10
R125 415 001..... 7-28	R125 492 000..... 7-31	R125 705 000.7-35,16-10	
R125 415 030..... 7-28	R125 492 001..... 7-31	R125 705 001.7-35,16-10	R127 712 001..... 10-18, 16-10
R125 415 270..... 7-28	R125 497 000..... 7-30	R125 710 021..... 7-35	
R125 415 271..... 7-28	R125 501 000..... 7-29	R125 720 000..... 7-35, 16-10, 17-19	R127 732 100..... 10-18, 16-10
R125 415 275..... 7-28	R125 501 001..... 7-29		
R125 416 460..... 7-28	R125 510 000..... 7-29	R125 720 001.7-35, 16-10, 17-19	R127 753 000..... 10-18, 16-10
R125 423 200..... 7-32	R125 510 001..... 7-29	R125 722 001..... 7-19	R127 800 001..... 10-16
R125 426 000..... 7-29	R125 510 500..... 7-29	R125 753 000.7-35,16-10	R127 800 101..... 10-16
R125 426 140..... 7-29	R125 510 501..... 7-29	R125 753 001.7-35,16-10	R127 820 001..... 10-17
R125 430 001..... 7-32	R125 512 000..... 7-31	R125 771 000.7-35,16-10	R127 840 021..... 10-17
R125 433 000..... 7-27	R125 512 001..... 7-31	R125 771 001.7-35,16-10	R127 841 001..... 10-17
R125 444 000..... 7-29	R125 513 000..... 7-31	R125 780 000.7-35,16-10	R127 842 001..... 10-17
R125 444 001..... 7-29	R125 541 000..... 7-32	R125 780 001.7-35,16-10	R127 842 101..... 10-17
R125 451 000..... 7-30	R125 553 000..... 7-27	R125 781 000.7-35,16-10	R127 870 001..... 10-18, 16-10
R125 452 000..... 7-30	R125 553 001..... 7-27	R125 781 001.7-35,16-10	
R125 453 000..... 7-26	R125 555 500..... 7-27	R125 791 501.7-35, 16-5, 16-10	R127 871 001..... 10-18, 16-10
R125 454 000..... 7-26	R125 556 001..... 7-34		
R125 454 001..... 7-26	R125 556 011..... 7-34	R125 792 501.7-35, 16-5, 16-10	R127 872 001..... 10-18, 16-10
R125 460 000..... 7-32	R125 560 000..... 7-27		
R125 460 001..... 7-32	R125 605 300..... 7-35	R125 802 000..... 7-36	
R125 462 000..... 7-31	R125 605 301..... 7-35	R125 802 001..... 7-36	
R125 462 001..... 7-31	R125 609 000..... 7-34	R125 812 000..... 7-36	<b>BMA</b>
R125 463 000..... 7-31	R125 609 001..... 7-34	R125 812 001..... 7-36	R128 052 000..... 7-6
R125 464 000..... 7-28	R125 609 011..... 7-34	R125 845 000..... 7-36	R128 052 827..... 7-6
R125 464 001..... 7-28	R125 609 031..... 7-34	R125 845 001..... 7-36	R128 052 901..... 7-6
R125 464 270..... 7-28	R125 610 000..... 7-30		R128 053 000..... 7-6

**Radiall Part Numbers**

R128 055 000..... 7-6	R128 474 211..... 7-9	R141 082 097..... 15-22	R141 403 000..... 9-20
R128 055 827..... 7-6	R128 474 847..... 7-9	R141 082 161.9-16,17-13	R141 404 000..... 9-20
R128 056 000..... 7-6	R128 474 857..... 7-9	R141 083 000..... 9-16	R141 406 000..... 9-20
R128 081 001..... 7-6	R128 481 001..... 7-10	R141 153 000..... 9-17	R141 407 000..... 9-20
R128 083 001..... 7-6	R128 481 011..... 7-10	R141 154 000..... 9-17	R141 410 000..... 9-20
R128 083 827..... 7-6	R128 484 001..... 7-9	R141 156 000..... 9-17	R141 426 000..... 9-22
R128 084 827..... 7-6	R128 490 021..... 7-10	R141 181 161..... 9-17	R141 426 161..... 9-22
R128 088 827..... 7-6	R128 545 011..... 7-10	R141 182 000..... 9-17	R141 426 168..... 9-22
R128 233 701..... 7-7	R128 555 101..... 7-10	R141 182 161..... 9-17	R141 440 000..... 9-22
R128 238 701..... 7-7	R128 556 001..... 7-10	R141 182 177.9-17,15-22	R141 453 000..... 9-20
R128 263 707..... 7-7	R128 595 001..... 7-10	R141 183 000..... 9-17	R141 554 000..... 9-21
R128 263 711..... 7-7	R128 609 701..... 7-10	R141 207 000..... 9-17	R141 557 000..... 9-21
R128 264 707..... 7-7	R128 639 000..... 7-10	R141 208 000..... 9-17	R141 559 000..... 9-21
R128 268 701..... 7-7	R128 639 001..... 7-10	R141 217 000..... 9-17	R141 563 161..... 9-21
R128 268 717..... 7-7	R128 639 020..... 7-10	R141 220 000..... 9-17	R141 572 000..... 9-21
R128 292 700..... 7-7	R128 639 071..... 7-10	R141 237 000..... 9-17	R141 574 000..... 9-21
R128 292 727..... 7-7	R128 639 100..... 7-10	R141 237 161..... 9-17	R141 574 161..... 9-21
R128 293 702..... 7-7	R128 665 100..... 7-8	R141 253 000..... 9-18	R141 580 000..... 9-22
R128 294 700..... 7-7	R128 665 820..... 7-8	R141 254 000..... 9-18	R141 603 000..... 9-21
R128 294 710..... 7-6	R128 705 711..... 7-11	R141 256 000..... 9-18	R141 605 000..... 9-21
R128 295 700..... 7-7		R141 257 000..... 9-18	R141 625 000..... 9-21
R128 295 727..... 7-7	<b>DTF</b>	R141 258 000..... 9-18	R141 654 000..... 9-20
R128 296 700..... 7-7	R139 705 023..... 16-9	R141 261 000..... 9-18	R141 665 000..... 9-22
R128 296 710..... 7-6		R141 277 000..... 9-18	R141 665 200..... 9-22
R128 359 707..... 7-8	<b>BNC</b>	R141 278 000..... 9-18	R141 680 000..... 9-20
R128 360 701..... 7-8	R141 003 000..... 9-16	R141 290 200..... 9-18	R141 703 000.9-23, 16-9
R128 360 717..... 7-8	R141 004 000..... 9-16	R141 292 000..... 9-18	R141 704 000.9-23, 16-9
R128 368 707..... 7-8	R141 005 000..... 9-16	R141 301 000.9-19,17-19	R141 710 000.9-23, 16-9
R128 405 161..... 7-8	R141 007 000..... 9-16	R141 303 503.9-19,17-19	R141 717 000.9-23, 16-9
R128 414 701..... 7-9	R141 007 161..... 9-16	R141 304 000.9-19,17-19	R141 720 000.9-23, 16-9
R128 424 848..... 7-8	R141 008 000..... 9-16	R141 306 000.9-19,17-19	R141 723 000.9-23, 16-9
R128 424 860..... 7-8	R141 009 000..... 9-16	R141 306 503.9-19,17-19	R141 723 161.9-23, 16-9
R128 425 110..... 7-8	R141 010 000..... 9-16	R141 308 000.9-19,17-19	R141 730 000.9-23, 16-9,
R128 425 300..... 7-8	R141 012 000..... 9-16	R141 323 000.9-19,17-19	17-19
R128 425 820..... 7-8	R141 018 000..... 9-16	R141 324 000.9-19,17-19	R141 753 000.9-23, 16-9,
R128 426 700..... 7-9	R141 052 000..... 9-16	R141 324 200..... 9-19	17-19
R128 426 710..... 7-9	R141 070 520..... 9-16	R141 327 000.9-19,17-19	R141 770 000.9-23, 16-9,
R128 427 700..... 7-9	R141 072 000..... 9-16	R141 331 500..... 9-19	17-19
R128 444 201..... 7-9	R141 075 000..... 9-16	R141 332 161..... 17-19	R141 780 000.9-23, 16-9
R128 444 307..... 7-9	R141 077 000..... 9-16	R141 332 500.9-19,17-19	R141 782 000.9-23, 16-9
R128 464 701..... 7-9	R141 082 000..... 9-16	R141 338 000.9-19,17-19	R141 789 000.9-23, 16-9
R128 474 201..... 7-9		R141 338 007.9-19,15-22	

**Radiall Part Numbers**

R141 799 000.9-23, 16-9	R142 079 768..... 9-12	R142 562 290..... 17-19	R143 082 200..... 11-27,
R141 802 000.9-24,14-19	R142 079 769..... 9-12	R142 567 703..... 9-14	18-37
R141 805 000..... 9-24	R142 079 770..... 9-12	R142 568 703..... 9-14	R143 082 700..... 10-10
R141 812 000.9-24,14-19	R142 079 771..... 9-12	R142 676 430..... 9-28	R143 083 000..... 11-27
R141 842 000.9-24,14-19	R142 079 772..... 9-12	R142 676 700..... 9-14	R143 084 161..... 11-27,
R141 862 000..... 9-24	R142 079 773..... 9-12	R142 684 130..... 9-28	18-38
R141A 075 161..... 9-16	R142 079 774..... 9-12	R142 703 000.9-29, 16-9	R143 088 101..... 10-10
R141A 082 161..... 9-16	R142 079 775..... 9-12	R142 703 703.9-15, 16-9	R143 089 117..... 11-27,
R141A 306 000..... 9-19	R142 079 776..... 9-12	R142 704 000.9-29, 16-9	18-39
R141A 605 000..... 9-21	R142 079 777..... 9-12	R142 710 000.9-29, 16-9	R143 089 700..... 10-10
R141A 720 000..... 9-23	R142 079 778..... 9-12	R142 720 000.9-29, 16-9,	R143 092 790..... 10-10
R142 004 000..... 9-25	R142 079 779..... 9-12	17-19	R143 093 700..... 10-10
R142 016 000..... 9-25	R142 081 120..... 9-25	R142 720 700.9-15, 16-9	R143 097 700..... 10-10
R142 016 161..... 9-25	R142 081 130..... 9-25	R142 723 000.9-29, 16-9	R143 154 100..... 11-28
R142 017 000..... 9-25	R142 083 000..... 9-25	R142 770 000.9-29, 16-9	R143 156 000..... 11-28
R142 018 000..... 9-25	R142 085 000..... 9-25	R142 780 000.9-29, 16-9	R143 181 161..... 11-28
R142 076 000..... 9-25	R142 085 161.9-25,17-13	R142 782 000.9-29, 16-9	R143 182 000..... 11-28
R142 076 161..... 9-25	R142 085 702..... 9-13	R142 789 000.9-29, 16-9	R143 183 000..... 11-28
R142 077 702..... 9-13	R142 086 161..... 9-25	R142A 076 161..... 9-25	R143 188 101..... 10-10
R142 077 712..... 9-13	R142 090 000..... 9-25	R142A 081 130..... 9-25	R143 191 700..... 10-10
R142 077 722..... 9-13	R142 091 161..... 9-25	R142A 085 161..... 9-25	R143 207 000..... 11-29
R142 077 732..... 9-13	R142 095 000..... 9-25	R142A 306 500..... 9-27	R143 227 700..... 10-11
R142 077 742..... 9-13	R142 154 000..... 9-26	R142A 325 106..... 9-27	R143 235 161..... 11-28
R142 077 747..... 9-13	R142 157 000..... 9-26	R142A 334 161..... 9-27	R143 236 020..... 11-28
R142 079 750..... 9-12	R142 184 000..... 9-26		R143 237 000..... 11-28
R142 079 751..... 9-12	R142 184 161..... 9-26	<b>TNC</b>	R143 254 000..... 11-29
R142 079 752..... 9-12	R142 187 720..... 9-13	R143 004 000..... 11-27	R143 257 440..... 11-29
R142 079 753..... 9-12	R142 202 000..... 9-27	R143 008 000..... 11-27	R143 258 000..... 11-29
R142 079 754..... 9-12	R142 217 000..... 9-26	R143 012 000..... 11-27	R143 272 700..... 10-11
R142 079 755..... 9-12	R142 242 000..... 9-26	R143 018 000..... 11-27	R143 273 700..... 10-11
R142 079 756..... 9-12	R142 242 161..... 9-26	R143 018 500..... 11-27	R143 274 700..... 10-11
R142 079 757..... 9-12	R142 268 000..... 9-27	R143 051 700..... 10-10	R143 292 700..... 10-11
R142 079 758..... 9-12	R142 306 500.9-27,17-19	R143 052 000..... 11-27	R143 295 700..... 10-11
R142 079 759..... 9-12	R142 306 503.9-27,17-19	R143 054 700..... 10-10	R143 297 700..... 10-11
R142 079 760..... 9-12	R142 329 000.9-27,17-19	R143 072 000..... 11-27	R143 321 700..... 10-12
R142 079 761..... 9-12	R142 331 011..... 9-27	R143 073 000..... 11-27	R143 322 700..... 10-12
R142 079 762..... 9-12	R142 334 161.9-27,17-19	R143 075 000..... 11-27,	R143 323 000..... 11-30
R142 079 763..... 9-12	R142 334 700..... 9-14	18-35	R143 324 000..... 11-30
R142 079 764..... 9-12	R142 412 000..... 9-28	R143 082 000..... 11-27	R143 325 000..... 11-30
R142 079 765..... 9-12	R142 426 000..... 9-28	R143 082 027..... 11-27,	R143 331 161..... 11-29
R142 079 766..... 9-12	R142 500 740..... 9-14	18-36	R143 332 161..... 11-29
R142 079 767..... 9-12	R142 562 000..... 9-28	R143 082 161..... 11-27	R143 337 000..... 11-30

**Radiall Part Numbers**

R143 340 700..... 10-12	R143 812 000..... 11-31	R161 083 000..... 11-11	R161 286 000..... 11-14
R143 404 000..... 11-30	R143 835 000..... 11-31	R161 083 137..... 11-11	R161 311 200..... 11-15
R143 405 000..... 11-30	R143 850 700..... 10-13	R161 088 000..... 11-11	R161 311 300..... 11-15
R143 412 700..... 10-12	R144 085 000..... 11-31	R161 088 137..... 11-11	R161 321 000..... 11-15
R143 420 000..... 11-30	R144 085 161..... 11-31	R161 088 180..... 11-11,	R161 322 000..... 11-15
R143 422 947.5-14,11-31	R144 334 161..... 11-31	18-39	R161 323 000..... 11-16
R143 422 957.5-14,11-31		R161 152 107..... 11-13	R161 325 000..... 11-15
R143 440 000..... 11-31	<b>UHF</b>	R161 157 000..... 11-12	R161 329 000..... 11-15
R143 557 000..... 11-30	R155 003 000..... 14-22	R161 168 000..... 11-12	R161 329 130..... 11-15,
R143 603 000..... 11-30	R155 005 000..... 14-22	R161 181 000..... 11-12	18-37
R143 626 000..... 11-30	R155 404 161..... 14-22	R161 182 000..... 11-12	R161 329 140..... 11-15,
R143 654 000..... 11-31	R155 405 000..... 14-22	R161 182 080..... 11-12,	18-38
R143 703 000..... 11-32,	R155 560 000..... 14-22	18-37	R161 329 200..... 11-15
16-10	R155 705 000..... 16-10	R161 183 000..... 11-12	R161 331 060..... 11-15,
R143 703 700..... 10-13,		R161 183 310..... 11-12,	18-39
16-10	<b>N</b>	18-38	R161 331 200..... 11-15
R143 704 000..... 11-32,	R161 004 000..... 11-11	R161 184 080..... 11-12,	R161 331 400..... 11-15,
16-10	R161 006 000..... 11-11	18-39	18-40
R143 704 700..... 10-13,	R161 010 000..... 11-11	R161 185 000..... 11-12	R161 332 000..... 11-15
16-10	R161 012 000..... 11-11	R161 186 000..... 11-12	R161 335 200..... 11-16
R143 705 700..... 10-13,	R161 018 000..... 11-11	R161 187 000..... 11-12	R161 336 000..... 11-16
16-10	R161 020 000..... 11-11	R161 188 200..... 11-12,	R161 336 200..... 11-16
R143 710 000..... 11-32,	R161 022 000..... 11-11	18-40	R161 337 200..... 11-16
16-5, 16-10	R161 027 000..... 11-11	R161 206 000..... 11-13	R161 404 000..... 11-17
R143 710 700..... 10-13,	R161 050 300..... 11-12	R161 220 000..... 11-13	R161 404 137..... 11-17
16-10	R161 051 000..... 11-12	R161 226 020..... 11-13	R161 404 C01..... 11-18
R143 713 000..... 11-32,	R161 052 000..... 11-12	R161 227 000..... 11-13	R161 404 C02..... 11-18
16-5, 16-10	R161 053 000..... 11-12	R161 236 000..... 11-13	R161 404 C03..... 11-18
R143 713 200..... 11-32,	R161 054 000..... 11-12	R161 237 000..... 11-13	R161 410 000..... 11-17
16-10	R161 072 000..... 11-11,	R161 238 000..... 11-13	R161 410 130..... 11-17
R143 720 000..... 11-32,	18-35	R161 241 000..... 11-13	R161 410 520..... 11-16
16-10	R161 075 000..... 11-11	R161 243 000..... 11-13	R161 416 130..... 11-17
R143 730 700..... 10-13,	R161 075 030..... 11-11,	R161 252 000..... 11-14	R161 418 000..... 11-17
16-10	18-38	R161 256 000..... 11-14	R161 419 020..... 11-17
R143 753 000..... 11-32,	R161 075 060..... 11-11	R161 270 000..... 11-14	R161 419 30..... 11-17
16-10	R161 079 200..... 18-40	R161 277 000..... 11-14	R161 427 223..... 11-19
R143 770 000..... 11-32,	R161 082 000..... 11-11	R161 277 300..... 11-14	R161 428 223.5-15,11-19
16-10	R161 082 120..... 11-11,	R161 278 000..... 11-14	R161 428 233.5-15,11-19
R143 780 000..... 11-32,	18-36	R161 281 000..... 11-14	R161 438 200..... 11-17
16-10	R161 082 200..... 11-11,	R161 281 300..... 11-14	R161 441 000..... 11-17
R143 782 000..... 11-32,	18-37	R161 282 000..... 11-14	R161 441 400..... 11-17
16-10	R161 083 000..... 11-11	R161 283 000..... 11-14	R161 461 000..... 11-17



**Radiall Part Numbers**

R161 570 000..... 11-18  
 R161 606 000..... 11-18  
 R161 625 000..... 11-18  
 R161 653 000..... 11-18  
 R161 703 000.11-19,16-9  
 R161 705 000.11-19,16-9  
 R161 715 000.11-19,16-9  
 R161 730 000.11-19,16-9  
 R161 753 000.11-19,16-9  
 R161 771 000.11-19,16-9  
 R161 780 000.11-19,16-9  
 R161 782 000.11-19,16-9  
 R161 791 500..... 11-19,  
 16-5, 16-9  
 R161 791 530.11-19,16-9  
 R161 804 000..... 11-20  
 R161 805 410..... 11-20  
 R161 841 000..... 11-20  
 R161 844 000..... 11-20  
 R161 853 000..... 11-20  
 R161 862 000..... 11-20  
 R161A 075 000..... 11-11  
 R161A 183 000..... 11-12  
 R161A 404 000..... 11-17  
 R161A 410 000..... 11-17  
 R162 012 000..... 11-21  
 R162 013 000..... 11-21  
 R162 017 000..... 11-21  
 R162 084 000..... 11-21  
 R162 217 000..... 11-21  
 R162 262 000..... 11-21  
 R162 322 000..... 11-21  
 R162 403 000..... 11-22  
 R162 570 000..... 11-22  
 R162 703 000.11-22,16-9  
 R162 705 000.11-22,16-9

**N 18**

R163 337 001..... 10-7  
 R163 703 001. 10-7, 16-9  
 R163 705 001. 10-7, 16-9  
 R163 708 001. 10-7, 16-9

**QN**

R164 054 002..... 8-16  
 R164 075 000..... 8-16  
 R164 075 010.8-16,18-38  
 R164 076 000..... 8-16  
 R164 080 000..... 8-16  
 R164 080 020.8-16,18-39  
 R164 080 030.8-16,18-40  
 R164 152 100..... 8-17  
 R164 175 000..... 8-17  
 R164 176 000..... 8-17  
 R164 184 000..... 8-17  
 R164 185 007.8-17,18-39  
 R164 241 020.8-17,18-39  
 R164 286 000..... 8-17  
 R164 329 200..... 8-18  
 R164 336 000..... 8-17  
 R164 418 000..... 8-18  
 R164 428 823..... 5-15  
 R164 428 833..... 5-15  
 R164 540 027..... 8-18  
 R164 571 027..... 8-18  
 R164 606 000..... 8-19  
 R164 606 020..... 8-19  
 R164 635 002..... 8-18  
 R164 705 000.8-19, 16-9  
 R164 708 000.8-19, 16-9  
 R164 804 000..... 8-20

**C**

R166 005 000..... 11-37  
 R166 018 000..... 11-37  
 R166 088 100..... 11-37  
 R166 092 190..... 11-37  
 R166 093 000..... 11-37  
 R166 094 000..... 11-37  
 R166 160 020..... 11-37  
 R166 168 000..... 11-37  
 R166 191 000..... 11-37  
 R166 194 190..... 11-37  
 R166 218 000..... 11-37

R166 256 000..... 11-37  
 R166 268 000..... 11-37  
 R166 404 000..... 11-38  
 R166 404 001..... 11-38  
 R166 705 000.11-38,16-9  
 R166 753 000.11-38,16-9  
 R166 770 000.11-38,16-9

**4.1-9.5**

R170 031 007..... 13-25  
 R170 031 107..... 13-25  
 R170 031 207..... 13-25  
 R170 152 107..... 13-25  
 R170 413 127..... 13-25  
 R170 703 007..... 16-9

**HN**

R176 006 000..... 15-5  
 R176 012 000..... 15-5  
 R176 018 000..... 15-5  
 R176 019 000..... 15-5  
 R176 021 000..... 15-5  
 R176 027 000..... 15-5  
 R176 218 000..... 15-5  
 R176 256 000..... 15-5  
 R176 268 000..... 15-5  
 R176 404 000..... 15-5  
 R176 754 000.15-6, 16-9  
 R176 754 150.15-6, 16-9  
 R176 770 000.15-6, 16-9  
 R176 811 000..... 15-6  
 R176 830 010..... 15-6

**4.3-10**

R183 010 007..... 13-21  
 R183 010 017..... 13-21  
 R183 030 007..... 13-21  
 R183 030 017..... 13-21  
 R183 031 007..... 13-21  
 R183 031 017..... 13-21  
 R183 032 007..... 13-21

R183 052 007..... 13-21  
 R183 165 007..... 13-22  
 R183 197 007..... 13-21  
 R183 252 007..... 13-22  
 R183 405 067..... 13-22  
 R183 804 020..... 13-22

**QLI**

R184 006 007..... 13-17  
 R184 018 007..... 13-17  
 R184 037 007..... 13-17  
 R184 061 007..... 13-17  
 R184 062 007..... 13-17  
 R184 082 007..... 13-17  
 R184 086 007..... 13-17  
 R184 087 007..... 13-17  
 R184 191 007..... 13-17  
 R184 216 007..... 13-17  
 R184 282 007..... 13-18  
 R184 335 007..... 13-18  
 R184 339 007..... 13-18  
 R184 405 007..... 13-18  
 R184 960 007..... 13-18

**7-16**

R185 010 000..... 13-9  
 R185 054 020..... 13-9  
 R185 074 000..... 13-9  
 R185 077 000..... 13-9  
 R185 077 010.13-9,18-40  
 R185 083 310..... 13-9  
 R185 085 007..... 13-9,  
 18-38, 18-39  
 R185 160 000..... 13-9  
 R185 174 000..... 13-9  
 R185 177 000..... 13-9  
 R185 210 000..... 13-10  
 R185 215 200..... 13-10  
 R185 216 200..... 13-10  
 R185 217 200..... 13-10  
 R185 252 000..... 13-10



**Radiall Part Numbers**

R185 260 000..... 13-10	R191 201 007..... 16-7	R191 354 001..... 16-6	R191 553 000..... 3-17
R185 314 100..... 13-11	R191 201 800..... 16-6	R191 355 001..... 16-6	R191 553 800..... 16-6
R185 320 020..... 13-11, 18-38, 18-39	R191 203 007..... 16-7	R191 365 000..... 16-7	R191 560 000...3-9, 3-17
R185 403 490..... 13-11	R191 209 000..... 16-6	R191 366 071.5-11, 16-4	R191 562 000.2-10, 16-5
R185 403 547..... 13-11	R191 212 000..... 16-6	R191 366 091.5-11, 16-4	R191 563 000.2-10, 16-5
R185 404 200..... 13-11	R191 212 500..... 16-6	R191 374 000..... 16-7	R191 564 000.2-10, 16-5
R185 405 200..... 13-11	R191 213 000..... 16-6	R191 377 000..... 16-7	R191 565 000.2-10, 16-5
R185 406 090..... 13-11	R191 214 000..... 16-6	R191 381 000..... 16-7	R191 570 100..... 16-8
R185 703 000.13-12,16-9	R191 215 000..... 16-6	R191 385 000..... 16-6	R191 591 007..... 16-6
R185 705 000.13-12,16-9	R191 233 000..... 16-7	R191 386 000..... 16-6	R191 591 017..... 16-6
R185 707 000.13-12,16-9	R191 236 000..... 16-7	R191 387 000..... 16-6	R191 592 007..... 16-6
R185 710 000.13-12,16-9	R191 239 000..... 16-7	R191 387 107..... 16-6	R191 592 017..... 16-6
R185 730 020.13-12,16-9	R191 300 800..... 16-6	R191 388 000..... 16-6	R191 593 400..... 2-25
R185 812 007..... 13-12	R191 301 000..... 16-6	R191 389 100...3-9, 16-6	R191 597 800...1-7, 16-6
R187 130 000..... 13-13	R191 303 000..... 16-6	R191 389 200...3-9, 16-6	R191 662 000..... 16-4
R187 403 000..... 13-13	R191 305 000..... 16-6	R191 389 300 ..3-9, 16-6	R191 663 000..... 16-4
R187 403 010..... 13-13	R191 309 000..... 16-8	R191 389 400 ..3-9, 16-6	R191 664 000..... 16-4
R187 403 100..... 13-13	R191 311 000..... 16-7	R191 389 800..... 16-6	R191 665 000..... 16-4
R187 406 000..... 13-13	R191 313 000..... 16-7	R191 394 027..... 1-12	R191 703 000..... 16-6
R187 406 100..... 13-13	R191 314 700..... 16-5	R191 398 020..... 16-6	R191 705 000..... 16-6
R187 413 000..... 13-13	R191 314 730..... 16-5	R191 399 100..... 16-6	R191 708 000..... 16-6
R187 413 100..... 13-13	R191 315 000..... 16-7	R191 403 000..... 16-6	R191 720 000..... 16-6
R187 416 000..... 13-13	R191 316 700..... 16-5	R191 405 000..... 16-6	R191 721 000..... 16-6
R187 416 100..... 13-13	R191 318 700..... 16-5	R191 417 000..... 16-6	R191 722 000..... 16-6
	R191 324 000..... 16-5	R191 419 000..... 16-6	R191 723 000..... 16-6
	R191 325 000..... 16-7	R191 421 000..... 16-6	R191 731 000..... 16-7
	R191 326 000..... 16-5	R191 422 000..... 16-6	R191 733 000..... 16-7
	R191 327 000..... 16-7	R191 424 000..... 16-6	R191 737 000..... 16-6
	R191 328 000..... 16-5	R191 429 000..... 16-6	R191 741 000..... 16-6
	R191 329 000..... 16-7	R191 445 000..... 16-6	R191 757 000.8-19, 16-4
	R191 330 000..... 16-5	R191 447 000..... 16-8	R191 758 000..... 8-19
	R191 331 000..... 16-7	R191 449 000..... 16-6	R191 759 000.8-19, 16-4
	R191 332 000..... 16-7	R191 450 000..... 20-30	R191 760 000.8-19, 16-4
	R191 333 000..... 16-5	R191 453 000.16-6,20-30	R191 760 010..... 16-4
	R191 334 000..... 16-7	R191 454 000.16-6,20-30	R191 762 000.8-19, 16-4
	R191 347 000..... 16-7	R191 455 000.16-6,20-30	R191 763 000.8-19, 16-4
	R191 349 000..... 16-7	R191 477 120..... 16-6	R191 764 000.8-19, 16-4
	R191 350 001..... 16-6	R191 511 000..... 16-7	R191 765 000.8-19, 16-4
	R191 351 701..... 16-6	R191 513 000..... 16-7	R191 792 000..... 16-4
	R191 352 001..... 16-6	R191 513 050..... 16-7	R191 793 000..... 16-4
	R191 353 701..... 16-6	R191 514 000..... 16-7	R191 794 000..... 16-4
	R191 353 711..... 16-6	R191 552 000..... 3-17	R191 811 110..... 16-6

**ADAPTERS**

R191 003 000..... 16-5	R191 007 000..... 16-5	R191 009 000..... 16-5	R191 010 000..... 16-5	R191 011 000..... 16-5	R191 012 000..... 16-5	R191 013 000..... 16-5	R191 015 000..... 16-5	R191 025 000..... 16-5	R191 027 000..... 16-5	R191 117 000..... 16-6	R191 120 000..... 16-6	R191 123 000..... 16-6	R191 124 000..... 16-6	R191 200 007..... 16-7
------------------------	------------------------	------------------------	------------------------	------------------------	------------------------	------------------------	------------------------	------------------------	------------------------	------------------------	------------------------	------------------------	------------------------	------------------------

**Radial Part Numbers**

R191 841 001.2-21, 16-7  
 R191 842 002.2-21, 16-7  
 R191 843 001.2-21, 16-7  
 R191 843 409.2-21, 16-7  
 R191 843 429.2-21, 16-7  
 R191 844 002.2-21, 16-7  
 R191 844 800..... 16-6  
 R191 857 000...5-8, 16-4  
 R191 907 000..... 16-6  
 R191 908 000..... 16-6  
 R191 910 000.8-11, 16-4  
 R191 911 000.8-11, 16-4  
 R191 912 000.8-11, 16-4  
 R191 913 000.8-11, 16-4  
 R191 923 000..... 16-4  
 R191 926 L01.8-23, 16-4  
 R191 927 L01.8-23, 16-4  
 R191 933 000..... 16-6  
 R191 944 700..... 16-4  
 R191 946 700..... 16-4  
 R191 956 020.2-10, 16-5  
 R191 957 000.2-10, 16-5  
 R191 958 000.2-10, 16-5  
 R191 958 020.2-10, 16-5  
 R191 959 000.2-21, 16-5  
 R191 966 001.2-21, 16-5  
 R191 967 002.2-21, 16-5  
 R191 968 001.2-21, 16-5  
 R191 969 002.2-21, 16-5  
 R191 970 061.10-19,16-5  
 R191 970 071.10-19,16-5  
 R191 970 081.10-19,16-5  
 R191 970 091.10-19,16-5  
 R191 975 781.1-12, 16-4  
 R191 975 791..... 1-12  
 R191 976 020..... 16-4  
 R191 977 020..... 16-4  
 R191 977 520..... 16-5  
 R191 984 008..... 16-4  
 R191 996 110..... 3-17  
 R191 996 130..... 3-17  
 R192 417 010..... 9-15

R192 418 000..... 16-4  
 R192 418 010..... 9-15  
 R192 419 000..... 16-4  
 R192 421 000..... 16-4

**COAXIPACK 2**

R199 001 003..... 4-13  
 R199 001 023..... 4-13  
 R199 001 053..... 4-13  
 R199 001 203..... 4-10  
 R199 001 223..... 4-10  
 R199 001 703.4-11, 16-9  
 R199 001 713.4-11, 16-9  
 R199 001 733.4-11, 16-9

**MC-CARD**

R199 005 200..... 5-10  
 R199 005 233..... 5-10  
 R199 005 240..... 5-10  
 R199 005 250..... 5-10  
 R199 005 273..... 5-10  
 R199 005 310..... 5-10  
 R199 005 800..... 5-10  
 R199 005 820..... 5-10  
 R199 005 890..... 5-11

**MOEBIUS**

R199 006 203..... 5-8  
 R199 006 213 ..... 5-8  
 R199 006 263..... 5-8  
 R199 006 273..... 5-8  
 R199 006 413..... 5-7  
 R199 006 813..... 5-7

**SMPM**

R201 051 000..... 2-7  
 R201 052 000..... 2-7  
 R201 151 000..... 2-7  
 R201 152 000..... 2-7  
 R201 170 110..... 2-7  
 R201 223 100..... 2-7

R201 223 700..... 2-7  
 R201 223 710..... 2-7  
 R201 423 110..... 2-8  
 R201 423 200..... 2-8  
 R201 423 700..... 2-8  
 R201 450 001..... 2-9  
 R201 450 701..... 2-9  
 R201 508 000..... 2-8  
 R201 508 040..... 2-8  
 R201 508 700..... 2-8  
 R201 561 021..... 2-9  
 R201 561 721..... 2-9  
 R201 645 000..... 2-8  
 R201 645 020..... 2-8  
 R201 645 700..... 2-8  
 R201 645 710..... 2-8  
 R201 645 720..... 2-8  
 R201 705 000..... 2-9  
 R201 705 110..... 2-9  
 R201 705 120..... 2-9  
 R201 723 1\_0..... 2-9

**SSMB**

R203 073 000..... 12-8  
 R203 075 000..... 12-8  
 R203 173 000..... 12-8  
 R203 173 080..... 12-8  
 R203 175 000..... 12-8  
 R203 313 000..... 12-9  
 R203 426 000..... 12-10  
 R203 553 000..... 12-9  
 R203 665 000..... 12-11

**MMS**

R209 351 020..... 1-11  
 R209 353 000..... 1-11  
 R209 408 012..... 1-12  
 R209 408 052..... 1-12  
 R209 408 302..... 1-12  
 R209 703 070.1-12, 16-9

**MMT**

R210 157 010..... 1-11  
 R210 160 020..... 1-11  
 R210 408 012..... 1-12  
 R210 408 052..... 1-12  
 R210 408 302..... 1-12  
 R210 703 507..... 16-9

**MCX**

R213 053 037..... 1-21  
 R213 082 007..... 1-21  
 R213 083 007..... 1-21  
 R213 182 007..... 1-21  
 R213 183 007..... 1-21  
 R213 238 007..... 1-22  
 R213 424 800..... 1-23  
 R213 664 800..... 1-24  
 R213 665 000..... 1-24

**TYPE 43**

R214 083 922 ..... 14-6  
 R214 088 902..... 14-7  
 R214 088 922..... 14-7  
 R214 318 702..... 14-7  
 R214 318 722..... 14-7  
 R214 320 702..... 14-7  
 R214 320 722..... 14-7  
 R214 325 742..... 14-7  
 R214 426 704..... 14-6  
 R214 553 000..... 14-6  
 R214 790 703..... 14-8  
 R214 791 703..... 14-8  
 R214 797 703..... 14-8  
 R214 797 723..... 14-8  
 R214 798 703..... 14-8  
 R214 798 723..... 14-8

**Radiall Part Numbers****SMP**

R222 051 000..... 2-15  
 R222 052 000..... 2-15  
 R222 052 300..... 2-15  
 R222 062 100..... 2-15  
 R222 151 000..... 2-15  
 R222 152 000..... 2-15  
 R222 162 100..... 2-15  
 R222 223 002..... 2-15  
 R222 223 302..... 2-15  
 R222 223 702..... 2-15  
 R222 252 001..... 2-16  
 R222 252 301..... 2-16  
 R222 252 702..... 2-16  
 R222 302 002..... 2-15  
 R222 302 302..... 2-15  
 R222 302 702..... 2-15  
 R222 402 021..... 2-19  
 R222 402 321..... 2-19  
 R222 402 721..... 2-19  
 R222 408 350..... 2-17  
 R222 408 750..... 2-17  
 R222 411 001..... 2-18  
 R222 414 711..... 2-18  
 R222 423 023..... 2-17  
 R222 423 041..... 2-16  
 R222 423 320..... 2-17  
 R222 423 720..... 2-17  
 R222 426 000..... 2-16  
 R222 426 020..... 2-16  
 R222 426 300..... 2-16  
 R222 426 320..... 2-16  
 R222 426 700..... 2-16  
 R222 426 720..... 2-16  
 R222 428 000..... 2-17  
 R222 428 300..... 2-17  
 R222 428 700..... 2-17  
 R222 450 001..... 2-19  
 R222 508 000..... 2-17, 2-21  
 R222 508 300..... 2-17, 2-21  
 R222 508 700..... 2-17, 2-21  
 R222 508 722..... 2-17, 2-21

R222 550 001..... 2-20  
 R222 550 301..... 2-20  
 R222 550 701..... 2-20  
 R222 561 001..... 2-18  
 R222 561 301..... 2-18  
 R222 561 331..... 2-18  
 R222 561 701..... 2-18  
 R222 645 000..... 2-19  
 R222 645 020..... 2-19  
 R222 645 300..... 2-19  
 R222 645 320..... 2-19  
 R222 645 700..... 2-19  
 R222 680 000..... 2-18  
 R222 680 300..... 2-18  
 R222 680 700..... 2-18  
 R222 680 710..... 2-17, 2-21  
 R222 705 000..... 2-20  
 R222 705 200..... 2-20  
 R222 705 210..... 2-20  
 R222 705 220..... 2-20  
 R222 705 239..... 2-20  
 R222 705 250..... 2-20  
 R222 705 320..... 2-20  
 R222 705 340..... 2-20  
 R222 705 360..... 2-20  
 R222 705 370..... 2-20  
 R222 705 380..... 2-20  
 R222 705 400..... 2-20  
 R222 723 110..... 2-20  
 R222 723 120..... 2-20  
 R222 723 140..... 2-20

**SMP-COM**

R222 900 100..... 2-27  
 R222 900 130..... 2-27  
 R222 900 200..... 2-27  
 R222 900 310..... 2-27  
 R222 900 320..... 2-27  
 R222 900 330..... 2-27  
 R222 900 340..... 2-27  
 R222 900 357..... 15-20  
 R222 940 100..... 2-28

R222 940 300..... 2-28  
 R222 940 700..... 2-28  
 R222 941 100..... 2-28  
 R222 941 300..... 2-28  
 R222 941 324..... 15-21  
 R222 941 700..... 2-28  
 R222 995 320..... 2-28

**SMP-LOCK**

R222 L00 000..... 2-24  
 R222 L00 010..... 2-24  
 R222 L00 020..... 2-24  
 R222 L00 040..... 2-24  
 R222 L10 001..... 2-24  
 R222 L10 010..... 2-25  
 R222 L10 020..... 2-25  
 R222 L10 040..... 2-25  
 R222 L80 010..... 2-24  
 R222 L80 300..... 2-24

**SMP-MAX**

R222 M00 080..... 3-16  
 R222 M00 090..... 3-16  
 R222 M00 160..... 3-16  
 R222 M00 700..... 3-15  
 R222 M00 720..... 3-15  
 R222 M00 730..... 3-15  
 R222 M00 740..... 3-15  
 R222 M00 770..... 3-15  
 R222 M00 790..... 3-15  
 R222 M00 860..... 3-15  
 R222 M00 880..... 3-15  
 R222 M00 890..... 3-15  
 R222 M01 000..... 3-16  
 R222 M01 040..... 3-16  
 R222 M01 090..... 3-16  
 R222 M01 140..... 3-16  
 R222 M03 000..... 3-16  
 R222 M03 700..... 3-15  
 R222 M03 880..... 3-15  
 R222 M10 000..... 3-16

R222 M10 030..... 3-16  
 R222 M10 060..... 3-16  
 R222 M10 700..... 3-15  
 R222 M10 730..... 3-15  
 R222 M10 750..... 3-15  
 R222 M20 017..... 3-14  
 R222 M20 700..... 3-14  
 R222 M20 710..... 3-14  
 R222 M40 010..... 3-16  
 R222 M40 050..... 3-16  
 R222 M40 060..... 3-16  
 R222 M40 070..... 3-16  
 R222 M40 080..... 3-16  
 R222 M43 052..... 3-16  
 R222 M43 072..... 3-16  
 R222 M43 112..... 3-16  
 R222 M43 192..... 3-16  
 R222 M43 202..... 3-16  
 R222 M43 212..... 3-16  
 R222 M43 222..... 3-16  
 R222 M43 262..... 3-16  
 R222 M46 012..... 3-16  
 R222 M46 032..... 3-16  
 R222 M80 400..... 3-14  
 R222 M80 500..... 3-14  
 R222 M80 517..... 3-14

**MMBX**

R223 062 000..... 3-7  
 R223 081 000..... 3-7  
 R223 082 000..... 3-7  
 R223 083 000..... 3-7  
 R223 162 000..... 3-7  
 R223 181 000..... 3-7  
 R223 182 000..... 3-7  
 R223 183 000..... 3-7  
 R223 423 010..... 3-8  
 R223 423 800..... 3-8  
 R223 424 000..... 3-8  
 R223 424 800..... 3-8  
 R223 424 870..... 3-8  
 R223 425 000..... 3-8

**Radiall Part Numbers**

R223 425 800..... 3-8	R280 420 300..... 4-14	R280 566 006..... 17-22	10-23, 17-18
R223 425 810..... 3-8	R280 461 000..... 7-36,	R280 566 007..... 17-22	R280 760 050..... 17-18
R223 434 000..... 3-7	11-20, 17-17	R280 566 008..... 17-22	R280 902 000..... 17-19
R223 434 800..... 3-7	R280 461 200.7-36,17-17	R280 570 000..... 17-22	R280 907 000..... 17-19
R223 435 000..... 3-7	R280 461 210.7-36,17-17	R280 570 010..... 17-22	
R223 435 010..... 3-7	R280 462 000.7-36,17-17	R280 571 000..... 17-22	
R223 555 000..... 3-8	R280 463 000..... 7-36,	R280 572 000..... 17-22	
R223 703 020..... 3-9	11-20, 17-17	R280 573 000..... 17-22	
R223 703 040..... 3-9	R280 465 000.7-36,17-17	R280 574 000..... 17-22	
R223 703 080..... 3-9	R280 467 000..... 17-17	R280 575 000..... 17-22	
R223 703 180..... 3-9	R280 468 000..... 11-20,	R280 576 000..... 17-22	
R223 703 230..... 3-9	17-17	R280 577 000..... 17-22	
R223 720 020..... 3-9	R280 468 120..... 17-17	R280 578 000..... 17-22	
R223 990 000..... 3-10	R280 468 140..... 17-17	R280 579 000..... 17-22	
	R280 469 000..... 11-38,	R280 590 000..... 17-22	
	17-17	R280 591 000..... 17-22	
	R280 469 010..... 11-38,	R280 592 000..... 17-22	
	17-17	R280 593 000..... 17-22	
	R280 470 000..... 17-17	R280 594 000..... 17-22	
	R280 470 050..... 17-17	R280 595 000..... 17-22	
	R280 473 100..... 17-17	R280 596 000..... 17-22	
	R280 473 130..... 17-17	R280 597 000..... 17-22	
	R280 490 020..... 17-20	R280 598 000..... 17-22	
	R280 503 000..... 14-20,	R280 637 030..... 17-21	
	15-9, 17-20	R280 637 040..... 17-21	
	R280 505 000..... 17-20	R280 751 000.7-33,7-34,	
	R280 510 000.7-33,17-18	7-37, 17-18	
	R280 560 000..... 17-22	R280 751 080.7-37,17-18	
	R280 560 001..... 17-22	R280 751 350..... 7-34,	
	R280 560 002..... 17-22	7-37, 17-18	
	R280 560 003..... 17-22	R280 752 000..... 2-20,	
	R280 560 004..... 17-22	7-37, 17-18	
	R280 560 005..... 17-22	R280 752 020.7-37,17-18	
	R280 560 006..... 17-22	R280 755 000..... 7-34,	
	R280 560 007..... 17-22	7-37, 17-18	
	R280 560 008..... 17-22	R280 755 040.7-37,17-18	
	R280 566 000..... 17-22	R280 757 060..... 17-18	
	R280 566 001..... 17-22	R280 757 070..... 7-33,	
	R280 566 002..... 17-22	7-37, 17-18	
	R280 566 003..... 17-22	R280 757 080.7-37,17-18	
	R280 566 004..... 17-22	R280 760 000..... 17-18	
	R280 566 005..... 17-22	R280 760 040..... 10-18,	

**TOOLING**

R282 051 000..... 17-4, 17-8
R282 053 000..... 17-4, 17-9
R282 053 030..... 17-11
R282 053 100..... 17-9
R282 054 000..... 17-4
R282 055 000..... 17-4,
17-8, 17-9
R282 056 085..... 17-8
R282 056 118..... 17-4, 17-9
R282 059 010..... 17-11
R282 059 100..... 17-9
R282 061 030..... 17-11
R282 062 010..... 17-4
R282 063 000..... 17-4, 17-8
R282 066 000..... 17-4, 17-9
R282 066 100..... 17-9
R282 067 000..... 17-4, 17-9
R282 067 030..... 17-11
R282 078 000..... 17-11
R282 078 200..... 17-11
R282 078 220..... 17-11
R282 078 500..... 17-11
R282 080 000..... 17-5
R282 082 000..... 17-5
R282 102 000..... 17-8
R282 114 125..... 17-8
R282 114 162..... 17-9
R282 114 165..... 17-9
R282 120 010..... 17-9
R282 120 220..... 17-11
R282 122 010..... 17-10
R282 124 050..... 17-13
R282 124 075..... 17-13
R282 124 100..... 17-11
R282 125 010..... 17-10
R282 200 000..... 17-9

**Radiall Part Numbers**

R282 202 000..... 17-6	R282 360 004..... 17-6	R282 857 000..... 17-9	R284 008 001..... 1-11
R282 203 020..... 14-15	R282 370 020..... 17-10	R282 857 010..... 17-9	R284 008 004..... 1-11
R282 211 000..... 17-12	R282 730 040..... 17-9	R282 862 060..... 17-9	R284 906 002..... 14-14
R282 223 000..... 17-12, 17-13	R282 730 043..... 17-9	R282 862 070 ..... 17-10	R284C0431006 ..... 14-14
R282 227 000..... 17-12	R282 730 160..... 17-10	R282 862 080..... 17-10	R285 001 021..... 1-11
R282 231 000..... 17-11, 17-12	R282 730 161..... 17-10	R282 862 090..... 17-10	R285 004 001..... 1-11
R282 232 000..... 17-12	R282 740 000..... 17-5, 17-9, 17-10, 17-11	R282 862 100..... 17-10	R285 004 221..... 1-11
R282 234 000..... 17-12	R282 740 030.17-5,17-10	R282 864 110..... 17-8	R285 011 221..... 1-11
R282 235 003..... 17-12	R282 744 000..... 17-10	R282 864 120..... 17-9	R285 020 202..... 14-14
R282 235 011..... 17-12	R282 744 003 ..... 17-10	R282 867 020..... 14-15, 17-16	R285 020 212..... 14-14
R282 235 013..... 17-12	R282 744 010..... 17-9	R282 867 030..... 14-15, 17-16	R285 020 401..... 14-14
R282 271 000..... 17-12	R282 744 011..... 17-9	R282 868 000..... 17-17	R285 024 071..... 1-13
R282 281 000..... 17-13	R282 744 060..... 17-9	R282 868 040.1-13,17-16	R285 025 202..... 14-14
R282 293 000..... 17-12	R282 744 061..... 17-9	R282 868 100.1-13,17-16	R285 025 212..... 14-14
R282 300 000..... 17-14	R282 744 062..... 17-9	R282 868 201..... 17-15	R285 025 401..... 14-14
R282 303 000..... 17-14	R282 744 063..... 17-9	R282 868 230..... 17-16	R285 930 005..... 4-14
R282 303 010..... 17-14	R282 744 100..... 17-9	R282 868 300..... 17-15	
R282 303 020..... 17-14	R282 744 190..... 17-11	R282 914 000..... 17-9	<b>SPECIAL</b>
R282 303 230..... 17-14	R282 744 192..... 17-11	R282 914 010..... 17-9	R299 122 087..... 15-19
R282 303 500..... 17-14	R282 744 200..... 17-9	R282 915 010..... 17-9	R299 122 097..... 15-19
R282 318 000..... 17-14	R282 744 201..... 17-9	R282 915 020..... 17-10	R299 137 800..... 5-13
R282 319 000..... 17-14	R282 744 220..... 17-9	R282 915 030..... 17-10	R299 137 801..... 5-13
R282 320 000..... 17-14	R282 744 260..... 17-10	R282 915 040..... 17-10	
R282 320 030..... 17-14	R282 744 261 ..... 17-10	R282 918 000..... 17-15	<b>TOOLING</b>
R282 320 031..... 17-14	R282 744 270..... 17-10	R282 918 120..... 17-15	R299 510 010..... 17-7
R282 323 000..... 17-11, 17-14	R282 744 271..... 17-10	R282 918 150..... 17-15	R299 511 011 ..... 17-7
R282 339 001..... 17-6	R282 744 300..... 17-10	R282 918 160..... 17-15	R299 511 012..... 17-7
R282 339 004..... 17-6	R282 744 310..... 17-10	R282 918 200..... 17-15	R299 511 013..... 17-7
R282 339 005..... 17-6	R282 744 320..... 17-10	R282 918 210..... 17-15	R299 511 016..... 17-7
R282 340 000..... 17-12, 17-6	R282 744 330..... 17-10	R282 920 010..... 14-15, 17-15	R299 520 000.17-7,17-13
R282 341 010..... 17-34, 17-40, 17-5	R282 744 340..... 17-10	R282 920 100..... 14-15, 17-15	R299 521 011..... 17-7
R282 341 012.7-40, 17-5	R282 744 350..... 17-10	R282 920 120..... 17-15	R299 521 012..... 17-7
R282 344 127.17-8, 17-9	R282 750 000..... 17-8	R282 967 030..... 17-13	R299 521 013..... 17-7
R282 344 150.17-8, 17-9	R282 751 050..... 17-8	R282 983 000..... 17-13	R299 521 014..... 17-7
R282 360 001..... 17-6	R282 751 051..... 17-8		R299 521 015..... 17-7
R282 360 002..... 17-6	R282 751 070..... 17-8	<b>CABLE ASSEMBLIES AND PIGTAILS</b>	R299 521 017.17-7,17-13
R282 360 003..... 17-6	R282 751 071..... 17-8	R284 007 013..... 1-13	R299 522 000..... 17-7
	R282 760 000..... 17-9		R299 550 000..... 17-7
	R282 800 000..... 17-4		
	R282 800 001..... 17-4		

**Radiall Part Numbers****MC-CARD**

R299 794 800..... 5-11

**MML**

R302 000 000 xxx..... 1-5  
 R302 152 000..... 1-6  
 R302 153 000..... 1-7  
 R302 153 001..... 1-7  
 R302 155 000 xxx..... 1-5  
 R302 155 001..... 1-5  
 R302 159 000..... 17-16  
 R302 205 000 ..... 1-5  
 R302 205 001 xxx..... 1-5  
 R302 205 002..... 1-5  
 R302 205 003 xxx..... 1-6  
 R302 255 000 xxx..... 1-6  
 R302 255 001 xxx..... 1-6  
 R302 255 002 xxx..... 1-5  
 R302 255 003 xxx..... 1-5  
 R302 255 006 xxx..... 1-6  
 R302 255 014 xxx..... 1-6  
 R302 255 015 xxx..... 1-6  
 R302 302 000..... 1-6  
 R302 303 000..... 1-7  
 R302 303 001..... 1-7  
 R302 309 000..... 17-16

**BNC HT-MHV**

R316 004 000..... 15-8  
 R316 007 000..... 15-8  
 R316 011 000..... 15-8  
 R316 020 010..... 15-8  
 R316 072 000..... 15-8  
 R316 072 010..... 15-8  
 R316 207 000..... 15-8  
 R316 211 000..... 15-8  
 R316 257 000..... 15-8  
 R316 261 000..... 15-8  
 R316 405 000..... 15-9  
 R316 553 000..... 15-9  
 R316 603 000..... 15-9

R316 704 000.15-9, 16-9

R316 754 000.15-9, 16-9

**SHV**

R317 005 000..... 15-11  
 R317 072 000..... 15-11  
 R317 074 000..... 15-11  
 R317 255 000..... 15-11  
 R317 270 000..... 15-11  
 R317 405 000..... 15-12  
 R317 580 000..... 15-12  
 R317 720 000..... 15-12,  
 16-10

**QRE**

R324 054 L01..... 8-22  
 R324 055 L00..... 8-22  
 R324 195 L02..... 8-22  
 R324 256 L01..... 8-22  
 R324 434 L01..... 8-22  
 R324 555 L01..... 8-23

**2.4 MM**

R327 052 000..... 10-22  
 R327 052 202..... 10-22  
 R327 222 000..... 10-22  
 R327 222 200..... 10-22  
 R327 316 000..... 10-22  
 R327 316 010..... 10-22  
 R327 411 000..... 10-23  
 R327 430 000..... 10-23  
 R327 465 000..... 10-23  
 R327 556 000..... 10-22  
 R327 703 000.10-24,16-9  
 R327 704 000.10-24,16-9  
 R327 705 000.10-24,16-9  
 R327 771 000.10-24,16-9

**THT 20**

R331 018 000..... 15-13  
 R331 168 000..... 15-13

R331 405 000..... 15-14

R331 603 000..... 15-14

**MICROWAVE COMPONENT**

R404 012 000..... 19-5  
 R404 012 120..... 19-5  
 R404 014 000..... 19-5  
 R404 101 000..... 19-6  
 R404 101 120..... 19-6  
 R404 102 000..... 19-6  
 R404 104 000..... 19-6  
 R404 105 000..... 19-6  
 R404 110 000..... 19-5  
 R404 110 120..... 19-5  
 R404 110 150..... 19-10  
 R404 111 000..... 19-5  
 R404 111 120..... 19-5  
 R404 112 000..... 19-5  
 R404 114 000..... 19-5  
 R404 114 111..... 19-5  
 R404 114 120..... 19-5  
 R404 115 150..... 19-10  
 R404 116 000..... 19-6  
 R404 121 000..... 19-7  
 R404 121 120..... 19-7  
 R404 122 000..... 19-7  
 R404 131 000..... 19-5  
 R404 131 120..... 19-5  
 R404 132 000..... 19-5  
 R404 144 000..... 19-5  
 R404 155 000..... 19-6  
 R404 160 000..... 19-6  
 R404 165 000..... 19-6  
 R404 170 111..... 19-5  
 R404 175 111..... 19-5  
 R404 1D1 000 ..... 19-7  
 R404 1D1 121 ..... 19-7  
 R404 1D2 000 ..... 19-7  
 R404 1D2 121 ..... 19-7  
 R404 1D5 000 ..... 19-7  
 R404 210 150..... 19-10

R404 211 150..... 19-10

R404 215 150..... 19-10

R404 216 150..... 19-10

R404 225 000..... 19-7

R404 225 120..... 19-7

R404 240 000..... 19-5

R404 240 120..... 19-5

R404 240 121..... 19-5

R404 245 000..... 19-5

R404 260 000..... 19-7

R404 262 000..... 19-7

R404 270 000..... 19-5

R404 275 000..... 19-5

R404 280 000..... 19-6

R404 280 150..... 19-10

R404 285 000..... 19-6

R404 285 150..... 19-10

R404 340 000..... 19-5

R404 340 120..... 19-5

R404 350 150..... 19-10

R404 355 000..... 19-5

R404 355 150..... 19-10

R404 370 000..... 19-7

R404 370 120..... 19-7

R404 370 150..... 19-10

R404 375 000..... 19-7

R404 375 150..... 19-10

R404 380 000..... 19-7

R404 412 000..... 19-5

R404 441 000..... 19-5

R404 441 120..... 19-5

R404 441 121..... 19-5

R404 442 000..... 19-5

R404 442 120..... 19-5

R404 505 000..... 19-7

R404 506 000..... 19-8

R404 507 000..... 19-8

R404 510 000..... 19-7

R404 516 000..... 19-8

R404 517 000..... 19-8

R404 522 000..... 19-8

R404 555 000..... 19-7

**Radiall Part Numbers**

R404 556 000..... 19-8	R404 777 000..... 19-8	R410 1xx 121 ..... 19-13	R417 2xx 120 ..... 19-16
R404 557 000..... 19-8	R404 778 000..... 19-9	R410 2xx 121 ..... 19-13	R417 2xx 130 ..... 19-16
R404 560 000..... 19-7	R404 779 000..... 19-9	R411 7xx 124 ..... 19-12	R417 3xx 110 ..... 19-14
R404 564 000..... 19-7	R404 780 000..... 19-9	R411 8xx 119 ..... 19-12	R417 3xx 130 ..... 19-14
R404 566 000..... 19-8	R404 780 020..... 19-9	R411 8xx 121 ..... 19-12	R417 5xx 110 ..... 19-14
R404 567 000..... 19-8	R404 780 120..... 19-9	R411 8xx 124 ..... 19-12	R417 5xx 130 ..... 19-14
R404 571 000..... 19-8	R404 781 000..... 19-9	R412 3xx 124 ..... 19-12	R417 6xx 110 ..... 19-14
R404 572 000..... 19-8	R404 781 020..... 19-9	R412 4xx 000 ..... 19-12	R417 6xx 130 ..... 19-14
R404 585 000..... 19-8	R404 781 120..... 19-9	R412 4xx 124 ..... 19-12	R417 7xx 118 ..... 19-15
R404 585 500..... 19-8	R404 782 000..... 19-9	R412 5xx 000 ..... 19-13	R417 7xx 128 ..... 19-15
R404 586 000..... 19-8	R404 782 020..... 19-9	R412 5xx 124 ..... 19-13	R417 7xx 138 ..... 19-15
R404 586 500..... 19-8	R404 782 120..... 19-9	R412 700 124..... 19-12	R417 8xx 118 ..... 19-15
R404 587 000..... 19-8	R404 783 000..... 19-9	R412 7xx 000 ..... 19-12	R417 8xx 128 ..... 19-15
R404 587 500..... 19-8	R404 783 020..... 19-9	R412 8xx 000 ..... 19-12	R417 8xx 138 ..... 19-16
R404 588 000..... 19-8	R404 783 120..... 19-9	R413 2xx 150 ..... 19-17	R417 9xx 118 ..... 19-16
R404 588 500..... 19-8	R404 786 000..... 19-8	R413 3xx 000 ..... 19-13	R417 9xx 128 ..... 19-16
R404 600 000..... 19-6	R404 786 020..... 19-8	R413 3xx 150 ..... 19-17	R417 9xx 138 ..... 19-16
R404 605 000..... 19-6	R404 786 120..... 19-8	R413 8xx 000 ..... 19-13	R420 0xx 110 ..... 19-15
R404 750 000..... 19-8	R404 787 000..... 19-8	R413 8xx 115 ..... 19-13	R420 3xx 110 ..... 19-14
R404 751 000..... 19-8	R404 787 020..... 19-8	R413 8xx 121 ..... 19-13	R420 7xx 110 ..... 19-15
R404 752 000..... 19-8	R404 787 120..... 19-8	R413 8xx 150 ..... 19-17	R432 171 000..... 19-18
R404 753 000..... 19-8	R404 861 000..... 19-9	R414 4xx 150 ..... 19-17	R432 172 000..... 19-18
R404 756 000..... 19-7	R404 863 000..... 19-9	R414 5xx 000 ..... 19-13	R432 173 000..... 19-18
R404 758 000..... 19-8	R404 865 000..... 19-8	R414 5xx 150 ..... 19-17	R432 174 000..... 19-18
R404 759 000..... 19-8	R404 867 000..... 19-8	R414 5xx 161 ..... 19-13	R432 175 000..... 19-18
R404 760 000..... 19-9	R404 N01 000 ..... 19-6	R414 7xx 000 ..... 19-12	R432 271 000..... 19-18
R404 761 000..... 19-9	R404 N01 120 ..... 19-6	R414 7xx 150 ..... 19-17	R432 273 000..... 19-18
R404 762 000..... 19-9	R404 N01 121 ..... 19-6	R414 7xx 161 ..... 19-12	R432 274 000..... 19-18
R404 763 000..... 19-9	R404 N02 000 ..... 19-6	R415 3xx 000 ..... 19-14	R432 275 000..... 19-18
R404 764 000..... 19-9	R404 N03 000 ..... 19-6	R415 4xx 000 ..... 19-14	R432 371 000..... 19-18
R404 765 000..... 19-9	R404 N04 000 ..... 19-6	R415 5xx 000 ..... 19-14	R432 372 000..... 19-18
R404 766 000..... 19-8	R404 N05 000 ..... 19-6	R415 7xx 000 ..... 19-14	R432 373 000..... 19-18
R404 767 000..... 19-8	R404 N05 120 ..... 19-6	R416 0xx 000 ..... 19-14	R432 374 000..... 19-18
R404 768 000..... 19-9	R404 N05 121 ..... 19-6	R416 1xx 000 ..... 19-14	R432 375 000..... 19-18
R404 769 000..... 19-9	R404 N06 000 ..... 19-6	R416 8xx 000 ..... 19-14	R432 431 000..... 19-18
R404 770 000..... 19-9	R404 N07 000 ..... 19-6	R417 0xx 110 ..... 19-15	R432 432 000..... 19-18
R404 771 000..... 19-9	R404 N08 000 ..... 19-6	R417 0xx 120 ..... 19-15	R432 433 000..... 19-18
R404 772 000..... 19-9	R404 N61 000 ..... 19-7	R417 0xx 130 ..... 19-15	R432 434 000..... 19-18
R404 773 000..... 19-9	R404 N62 000 ..... 19-7	R417 1xx 110 ..... 19-15	R432 435 000..... 19-18
R404 774 000..... 19-9	R405 005 000..... 19-21	R417 1xx 120 ..... 19-15	R432 471 000..... 19-18
R404 775 000..... 19-9	R405 006 000..... 19-21	R417 1xx 130 ..... 19-16	R432 472 000..... 19-18
R404 776 000..... 19-8	R405 035 000..... 19-21	R417 2xx 110 ..... 19-16	R432 473 000..... 19-18



**Radial Part Numbers**

R432 474 000.....	19-18	R443 131 000.....	19-22	R499 101 000.....	19-22	R694 251 025.....	4-8
R432 475 000.....	19-18	R443 134 000.....	19-22	R499 103 000.....	19-22	R694 251 026.....	4-8
R432 531 000.....	19-18	R443 137 000.....	19-22			R694 251 027.....	4-8
R432 533 000.....	19-18	R443 141 000.....	19-22	<b>BR2</b>		R694 251 111.....	4-9
R432 534 000.....	19-20	R443 151 000.....	19-22	R605 004 000.....	14-18	R694 251 112.....	4-9
R432 535 000.....	19-20	R443 162 000.....	19-22	R605 005 000.....	14-18	R694 251 113.....	4-9
R432 571 000.....	19-18	R443 171 000.....	19-22	R605 006 000.....	14-18	R694 251 114.....	4-9
R432 573 000.....	19-20	R443 191 000.....	19-22	R605 156 000.....	14-18	R694 251 115.....	4-9
R432 574 000.....	19-20	R443 530 000.....	19-22	R605 206 000.....	14-18	R694 251 116.....	4-9
R432 631 000.....	19-18	R443 533 000.....	19-22	R605 256 000.....	14-18	R694 251 117.....	4-9
R432 633 000.....	19-20	R443 533 480.....	19-22	R605 400 000.....	14-19	R694 252 101.....	4-7
R432 634 000.....	19-20	R443 536 000.....	19-22	R605 440 000.....	14-19	R694 252 102.....	4-7
R432 635 000.....	19-20	R447 120 000.....	19-21	R605 550 000.....	14-19	R694 252 103.....	4-7
R433 423 000.....	19-20	R447 171 000.....	19-21	R605 550 020.....	14-19	R694 252 104.....	4-7
R433 424 000.....	19-20	R451 030 000.....	19-21	R605 600 000.....	14-19	R694 252 105.....	4-7
R433 463 000.....	19-20	R451 030 500.....	19-21			R694 252 106.....	4-7
R433 464 000.....	19-20	R451 031 000.....	19-21	<b>BANANAS</b>		R694 252 107.....	4-7
R433 503 000.....	19-20	R451 031 500.....	19-21	R644 020 000.....	20-27	R694 252 507.....	4-13
R433 513 700.....	19-20	R451 032 000.....	19-21	R644 030 000.....	20-27	R694 252 537.....	4-13
R433 514 700.....	19-20	R451 032 500.....	19-21	R644 120 000.....	20-27	R694 252 557.....	4-13
R433 523 000.....	19-20	R451 033 000.....	19-21	R644 121 000.....	20-27	R694 261 076.....	4-11
R433 524 000.....	19-20	R451 033 500.....	19-21	R644 130 000.....	20-27	R694 261 906.4-10, 4-11	
R433 563 000.....	19-20	R451 034 000.....	19-21	R644 131 000.....	20-27	R694 262 056.....	4-12
R433 564 000.....	19-20	R451 034 500.....	19-21	R644 133 000.....	20-26	R694 262 906.....	4-12
R433 611 700.....	19-18	R451 075 000.....	19-21	R644 543 000.....	20-26	R694 281 251.....	4-9
R433 612 700.....	19-20	R451 533 000.....	19-21	R644 543 001.....	20-26	R694 281 252.....	4-9
R433 613 700.....	19-20	R451 533 500.....	19-21	R644 543 002.....	20-26	R694 281 253.....	4-9
R433 614 700.....	19-20	R451 534 000.....	19-21	R644 543 003.....	20-26	R694 281 254.....	4-9
R433 623 000.....	19-20	R451 534 500.....	19-21	R644 543 004.....	20-26	R694 281 255.....	4-9
R433 624 000.....	19-20	R451 542 000.....	19-21	R644 543 020.....	20-26	R694 281 256.....	4-9
R433 663 000.....	19-20	R451 542 500.....	19-21	R644 543 021.....	20-26	R694 281 257.....	4-9
R433 664 000.....	19-20	R451 543 000.....	19-21	R644 543 022.....	20-26		
R433 721 700.....	19-18	R451 543 500.....	19-21	R644 543 023.....	20-26	<b>BANANAS</b>	
R433 723 700.....	19-20	R451 544 000.....	19-21	R644 543 024.....	20-26	R921 019 000.....	20-23
R433 724 700.....	19-20	R451 544 500.....	19-21	R644 823 000.....	20-28	R921 029 000.....	20-23
R433 831 700.....	19-18	R451 570 000.....	19-21	R644 833 000.....	20-28	R921 119 000.....	20-23
R433 832 700.....	19-20	R451 570 500.....	19-21			R921 149 000.....	20-23
R433 833 700.....	19-20	R451 572 120.....	19-21	<b>COAXIPACK 2</b>		R921 330 000.....	20-23
R433 834 700.....	19-20	R451 574 000.....	19-21	R694 251 021.....	4-8	R921 331 000.....	20-23
R435 170 000.....	19-22	R451 574 500.....	19-21	R694 251 022.....	4-8	R921 332 000.....	20-23
R435 270 000.....	19-22	R451 576 000.....	19-21	R694 251 023.....	4-8	R921 333 000.....	20-23
R435 470 000.....	19-22	R451 576 500.....	19-21	R694 251 024.....	4-8	R921 334 000.....	20-23



**Radiall Part Numbers**

R921 336 000.....	20-23	R929 991 003.....	20-26	R941 920 600.....	20-11
R921 390 000.....	20-30	R929 991 004.....	20-26	R941 920 602 .....	20-11
R921 391 000.....	20-30	R929 992 000.....	20-26	R941 920 603.....	20-11
R921 461 000.....	20-23	R929 993 000.....	20-26	R941 921 001.....	20-15
R921 609 000.....	20-24	R929 993 001.....	20-26	R941 921 600.....	20-11
R921 629 000.....	20-24	R929 993 002.....	20-26	R941 921 602.....	20-11
R921 820 070.....	20-28	R929 993 003.....	20-26	R941 921 603.....	20-11
R921 820 071.....	20-28	R929 993 004.....	20-26	R941 922 001.....	20-15
R921 820 072.....	20-28	R929 994 003.....	20-26	R941 922 600.....	20-11
R921 820 073.....	20-28	R941 019 000.....	20-14	R941 923 001.....	20-15
R921 820 074.....	20-28	R941 029 000.....	20-14	R941 923 600.....	20-11
R921 820 076.....	20-28	R941 049 000.....	20-14	R941 924 001.....	20-15
R921 850 000.....	20-28	R941 069 000.....	20-14	R941 924 600.....	20-11
R921 851 000.....	20-28	R941 149 000.....	20-14	R941 924 603.....	20-11
R921 910 000.....	20-28	R941 330 000.....	20-15	R941 926 001.....	20-15
R921 911 000.....	20-28	R941 331 000.....	20-15	R941 960 600.....	20-18
R921 912 000.....	20-28	R941 332 000.....	20-15	R941 961 600.....	20-18
R921 913 000.....	20-28	R941 333 000.....	20-15	R948 1xx 6xx.....	20-12
R921 914 000.....	20-28	R941 334 000.....	20-15	R948 3xx 6xx.....	20-12
R921 920 000.....	20-24	R941 336 000.....	20-15	R948 0xx 000 .....	20-16
R921 921 000.....	20-24	R941 340 000.....	20-15		
R921 922 000.....	20-24	R941 341 000.....	20-15		
R921 923 000.....	20-24	R941 342 000.....	20-15		
R921 924 000.....	20-24	R941 343 000.....	20-15		
R921 926 000.....	20-24	R941 344 000.....	20-15		
R921 930 000.....	20-24	R941 346 000.....	20-15		
R921 931 000.....	20-24	R941 460 000.....	20-15		
R921 932 000.....	20-24	R941 460 600.....	20-15		
R921 933 000.....	20-24	R941 461 000.....	20-15		
R921 934 000.....	20-24	R941 461 600.....	20-10		
R921 936 000.....	20-24	R941 462 600.....	20-10		
R928 0xx 000 .....	20-25	R941 463 600.....	20-10		
R928 1xx 000 .....	20-25	R941 464 600.....	20-10		
R929 000.....	20-25	R941 480 600.....	20-10		
R929 001.....	20-25	R941 481 600.....	20-10		
R929 100.....	20-25	R941 619 000.....	20-15		
R929 101.....	20-25	R941 629 000.....	20-15		
R929 500.....	20-25	R941 850 000.....	20-18		
R929 501.....	20-25	R941 850 600.....	20-18		
R929 991 000.....	20-26	R941 851 000.....	20-18		
R929 991 001.....	20-26	R941 851 600.....	20-18		
R929 991 002.....	20-26	R941 920 001.....	20-15		

SIMPLIFICATION IS OUR INNOVATION

# NOTE



# SIMPLIFICATION is our INNOVATION

*We advance the design and engineering process for innovators, ground-breakers and pioneers of technology. We reduce weight, improve durability and streamline installation to provide leading-edge connectors that drive product performance.*

## AREA OFFICES LOCAL CONTACTS

### EUROPE

ADDRESS	PHONE	FAX	EMAIL
<b>FINLAND</b> Radiall Finland PO Box 202, 90101, Oulu	+358407522412		infofi@radiall.com
<b>FRANCE</b> Radiall SA 25 Rue Madeleine Vionnet, 93300, Aubervilliers	+33149353535		info@radiall.com
<b>GERMANY</b> Radiall GmbH Carl-Zeiss-Straße 10, 63322, Rödermark	+49607491070	+496074910710	infode@radiall.com
<b>ITALY</b> Radiall Elettronica S.R.L. Via Zambelletti 19, 20021, Baranzate Milano	+39024885121	+390248843018	infoit@radiall.com
<b>NETHERLANDS</b> Radiall Nederland BV Hogebrinkerweg 15b, 3871, KM Hoevelaken	+31332534009	+31332534512	infonl@radiall.com
<b>SWEDEN</b> Radiall AB Sollentunavägen 63, 191 40 Sollentuna	+4684443410		infose@radiall.com
<b>UNITED KINGDOM</b> Radiall Ltd. Profile West, 950 Great West Rd., Brentford, Middlesex TW8 9ES	+441895425000	+441895425010	infouk@radiall.com

### ASIA

<b>CHINA</b> Shanghai Radiall Electronics Co., Ltd. No.390, Yonghe Road, Shanghai, 200072	+862166523788	+862166521177	infozh@radiall.com
<b>HONG KONG</b> Radiall Electronics (Asia) Ltd. Room A, 16/F., Ford Glory Plaza, 37-39 Wing Hong Street, Cheung Sha Wan, Kowloon, Hong Kong	+85229593833	+85229592636	infohk@radiall.com
<b>INDIA</b> Radiall India Pvt. Ltd. 25D, Phase 2, Peenya Industrial Area, Bengaluru 560 058	+98028395271	+918028397228	infoin@radiall.com
<b>JAPAN</b> Nihon Radiall K.K. Sawada Building 8F, Shibuya-ku, Tokyo 150-0011	+0364274455	+0364274456	infojp@radiall.com

### AMERICAS

<b>USA &amp; CANADA</b> Radiall USA, Inc. 8950 South 52nd Street, Ste. 401 Tempe, AZ 85284	+14806829400	+14806829403	infousa@radiall.com
--	--------------	--------------	---------------------

## GLOBAL PRESENCE

*Australia · Austria · Belgium · Brazil · Czech Republic · Denmark · Estonia · Greece · Hungary · Indonesia · Israel · Korea · Latvia · Lithuania  
Malaysia · Norway · Philippines · Poland · Portugal · Russia · Singapore · Spain · Switzerland · Taiwan · Thailand · Vietnam · South Africa*